

2020

GENERALE GENERAL CATALOGUE CATALOGU
GESAMTKATALOG CATÁLOGO GENERAL CATALC
LE GENERAL CATALOGUE CATALOGUE GENERA
TALOG CATÁLOGO GENERAL CATALOGO GENE
RAL CATALOGUE CATALOGUE GENERAL GESAM
CATÁLOGO GENERAL CATALOGO GENERALE GE
ALOGUE CATALOGUE GENERAL GESAMTKATALO
GENERAL CATALOGO GENERALE GENERAL CA
TALOGUE GENERAL GESAMTKATALOG CATÁLOG
ATALOGO GENERALE GENERAL CATALOGUE CA
ENERAL GESAMTKATALOG CATÁLOGO GENERA
GENERALE **GENERAL CATALOGUE** CATALOGU
GESAMTKATALOG CATÁLOGO GENERAL CATALC
LE GENERAL CATALOGUE CATALOGUE GENERA
TALOG CATÁLOGO GENERAL CATALOGO GENE
RAL CATALOGUE CATALOGUE GENERAL GESAM
CATÁLOGO GENERAL CATALOGO GENERALE GE
ALOGUE CATALOGUE GENERAL GESAMTKATALO
GENERAL CATALOGO GENERALE GENERAL CAT
ALOGUE GENERAL GESAMTKATALOG CATÁLOG
ATALOGO GENERALE GENERAL CATALOGUE CA
ENERAL GESAMTKATALOG CATÁLOGO GENERA
GENERALE GENERAL CATALOGUE CATALOGU
GESAMTKATALOG CATÁLOGO GENERAL CATALC
LE GENERAL CATALOGUE CATALOGUE GENERA
TALOG CATÁLOGO GENERAL CATALOGO GENE
RAL CATALOGUE CATALOGUE GENERAL GESAM

GRES PORCELLANATO
PORCELAIN STONEWARE

2020

Catalogo generale
General catalogue
Catalogue general
Gesamtkatalog
Catálogo general

INDICE GENERALE/

GENERAL INDEX / INDEX GÉNÉRAL /
ALLGEMEINER INDEX / ÍNDICE GENERAL

Indice per collezione /002

Index by collections / Sommaire des collections

Index für Kollektionen / Índice por colecciones

Indice per ispirazione /003

Index by inspiration / Sommaire des inspirations

Index für Inspiration / Índice por inspiración

Indice per formato /004

Index by size / Index par format

Verzeichnis der formate / Índice por formato

INTRO

INTRODUCTION/ PRÉSENTATION/ VORSTELLUNG / INTRODUCCIÓN

Azienda /006

Company / Société / Unternehmen / Empresa

Gres Porcellanato /008

Porcelain stoneware / Grès cérame

Feinsteinzeug / Gres porcelánico

Made in Italy /012

Greenthinking /014

Progetti /018

Projects / Projets / Projekte / Proyectos

COLLEZIONI

COLLECTIONS / COLLECTIONS / KOLLEKTIONEN / COLECCIONES

120x278 6mm range /032

Marble effect /036

Stone effect /072

Concrete&Design effect /206

Wood effect /258

Colour effect /282

Contract /296

K2 20mm range /326

K3 30mm range /334

AREA TECNICA

SPECS&TECH / DOMAINE TECHNIQUE / TECHNISCHER BEREICH /

ÀREA TÉCNICA

Legenda & simbologia /340

Tabella formati-colori-finiture /342

Tabella specifiche tecniche /354

Tabella DIN51130-DIN51097 /370

Misure-pesi-imballi /374

Certificazioni /380

Manuale di posa, uso e manutenzione /394

Condizioni generali di vendita /412

INDICE PER COLLEZIONE/

INDEX BY COLLECTIONS / SOMMAIRE DES
COLLECTIONS / INDEX FÜR KOLLEKTIONEN
/ ÍNDICE POR COLECCIONES

Alpi /156

Aran /086

Back /164

Beat /260

Brystone /074

Cementine /240

Chorus /106

Code /172

Dunstone CONTRACT /298

Eclectic /050

Mistiq White | Oniric White | Persian Grey |

Pinstripe Dark

Element Design /246

Element Lux /060

Calacatta | Calacatta Gold | Silver Grey | Emperador |

Crema Beige | Port Laurent | Lincoln

Evoke /268

Extreme CONTRACT /310

Granigliati - linea tecnica /290

Ikon /218

Interno4 /038

Calacatta San Babila | Carnico Brera |

Renoir Isola | Breccia Tortona

K-color /284

Langhe /182

Londale CONTRACT /302

Midlake /098

Quartzgrey | Quartzbeige | Ardesia | Porfido

Moov /228

Noord /208

Percorsi Extra /126

Pietra di Faedis | Pietra di Barge |

Pietra di Combe | Pietra di Vals

Percorsi Quartz /138

Percorsi Smart /146

Pietra di Bagnolo | Pietra di Bressa | Pietra di Lavis

Pietre di Keope /186

Point /190

Sight /196

Skywall CONTRACT /314

Soul /276

Suite /118

Sunrise /200

Swisstone CONTRACT /306

Urban CONTRACT /318

Way CONTRACT /322

INDICE PER ISPIRAZIONE/

INDEX BY INSPIRATION / SOMMAIRE DES INSPIRATIONS /
INDEX FÜR INSPIRATION / ÍNDICE POR INSPIRACIÓN

MARBLE EFFECT

Eclectic /050

Mistiq White | Oniric White | Persian Grey | Pinstripe Dark

Elements Lux /060

Calacatta | Calacatta Gold | Silver Grey | Emperador | Crema Beige |

Port Laurent | Lincoln

Interno4 /038

Calacatta San Babila | Carnico Brera | Renoir Isola | Breccia Tortona

STONE EFFECT

Alpi /156

Aran /086

Back /164

Brystone /074

Chorus /106

Code /172

Dunstone CONTRACT /298

Extreme CONTRACT /310

Langhe /182

Midlake /098

Quartzgrey | Quartzbeige | Ardesia | Porfido

Percorsi Extra /126

Pietra di Faedis | Pietra di Barge | Pietra di Combe | Pietra di Vals

Percorsi Quartz /138

Percorsi Smart /146

Pietra di Bagnolo | Pietra di Bressa | Pietra di Lavis

Pietre di Keope /186

Point /190

Sight /196

Suite /118

Sunrise /200

Swisstone CONTRACT /306

Way CONTRACT /322

CONCRETE&DESIGN EFFECT

Cementine /240

Elements Design /246

Ikon /218

Londale CONTRACT /302

Moov /228

Noord /208

Skywall CONTRACT /314

Urban CONTRACT /318

WOOD EFFECT

Beat /260

Evoke /268

Soul /276

COLOUR EFFECT

Granigliati-linea tecnica /290

K-Colour /284

INDICE PER FORMATO/

INDEX BY SIZE / INDEX PAR FORMAT

VERZEICHNIS DER FORMATE / ÍNDICE POR FORMATO

6 mm ▾

120x278

Brystone	/074
Eclectic	/050
Element Design	/246
Element Lux	/060
Ikon	/218
Interno4	/038
Moov	/228

9 mm ▾

120x240

Element Lux	/060
Moov	/228

30x240

Beat	/260
Evoke	/268
Soul	/276

80x160

Interno4	/038
----------	------

25x150

Soul	/276
------	------

12,3x150

Soul	/276
------	------

8,1x150

Soul	/276
------	------

120x120

Back	/164
Brystone	/074
Chorus	/106
Eclectic	/050
Elements Design	/246
Elements Lux	/060
Ikon	/218
Interno4	/038
Moov	/228
Noord	/208
Suite	/118

60x120

Aran	/086
Back	/164
Brystone	/074
Chorus	/106
Code	/172
Dunstone CONTRACT	/298
Eclectic	/050
Element Design	/246
Element Lux	/060
Ikon	/218
Interno4	/038
Londale CONTRACT	/302
Moov	/228
Noord	/208
Percorsi Extra	/126
Suite	/118
Sunrise	/200
Swisstone CONTRACT	/306

30x120

Aran	/086
Beat	/260
Brystone	/074
Chorus	/106
Code	/172
Eclectic	/050
Evoke	/268
Ikon	/218
Interno4	/038
Moov	/228
Noord	/208
Suite	/118

20x120

Beat	/260
Element Design	/246
Element Lux	/060
Evoke	/268
Moov	/228

15x120

Evoke	/268
-------	------

50x110

Element Design	/246
----------------	------

90x90

Ikon	/218
------	------

80x80

Interno4	/038
Noord	/208

75x75

Chorus	/106
Moov	/228

37,5x75

Chorus	/106
--------	------

60x60

Aran	/086
Back	/164
Brystone	/074
Chorus	/106
Code	/172
Dunstone CONTRACT	/298
Eclectic	/050
Elements Design	/246
Elements Lux	/060
Ikon	/218
Interno4	/038
Londale CONTRACT	/302
Moov	/228
Noord	/208
Percorsi Extra	/126
Percorsi Quartz	/138
Percorsi Smart	/146
Suite	/118
Sunrise	/200
Swisstone CONTRACT	/306
Urban CONTRACT	/318

40x60

Back	/164
Code	/172
Percorsi Extra	/126
Percorsi Quartz	/138
Percorsi Smart	/146
Sunrise	/200

30x60

Aran	/086
Back	/164
Brystone	/074
Chorus	/106
Code	/172
Dunstone CONTRACT	/298
Eclectic	/050
Elements Design	/246
Elements Lux	/060
Ikon	/218
Londale CONTRACT	/302
Moov	/228
Noord	/208
Percorsi Extra	/126
Percorsi Quartz	/138
Percorsi Smart	/146
Point	/190
Suite	/118
Sunrise	/200
Swisstone CONTRACT	/306
Urban CONTRACT	/318
Way CONTRACT	/322

20x60

Back	/164
Code	/172
Percorsi Extra	/126
Percorsi Quartz	/138
Percorsi Smart	/146
Suite	/118
Sunrise	/200

14,7x60

Moov	/228
------	------

9,7x60

Aran	/086
Back	/164
Brystone	/074
Chorus	/106
Code	/172
Elements Design	/246
Ikon	/218
Moov	/228
Noord	/208
Suite	/118

6,4x60

Back	/164
Moov	/228

3,1x60

Back	/164
Moov	/228

45x45

Moov	/228
------	------

22,5x45,3

Midlake	/098
---------	------

30x30

Alpi	/156
Cementine	/240
Granigliati /linea tec.	/290
Percorsi Extra	/126
Pietre di Keope	/186
Point	/190
Way CONTRACT	/322

15x30

Alpi	/156
Percorsi Smart	/146
Point	/190

7,5x30

Back	/164
Elements Design	/246
Moov	/228

22,5x22,5

Midlake	/098
---------	------

20x20

K-color	/284
---------	------

15x15

Alpi	/156
Langhe	/182
Point	/190

K2 20mm ▾

120x240

Percorsi Extra	/126
Percorsi Smart	/146

30x240

Percorsi Extra	/126
Percorsi Smart	/146

120x120

Moov	/228
Noord	/208
Percorsi Extra	/126
Percorsi Smart	/146

60x120

Aran	/086
Chorus	/106
Element Design	/246
Percorsi Extra	/126

40x120

Beat	/260
------	------

30x120

Evoke	/268
Percorsi Extra	/126
Soul	/276

90x90

Back	/164
Ikon	/218
Moov	/228

60x90

Brystone	/074
Midlake	/098

45x90

Extreme CONTRACT	/310
Percorsi Extra	/126
Percorsi Smart	/146

60x60

Back	/164
Chorus	/106
Extreme CONTRACT	/310
Ikon	/218
Moov	/228
Noord	/208
Percorsi Extra	/126
Percorsi Quartz	/138
Percorsi Smart	/146
Sight	/196
Skywall CONTRACT	/314
Swisstone CONTRACT	/306

30x60

Chorus	/106
Noord	/208

22,5x45,4

Midlake	/098
---------	------

22,5x22,5

Midlake	/098
---------	------

K3 30mm ▾

60x60

Moov	/228
Percorsi Extra	/126
Percorsi Smart	/146

AZIENDA

COMPANY / SOCIÉTÉ / UNTERNEHMEN / EMPRESA



IT_
“Simplicity is the ultimate sophistication”
(C.B. Luce)

Siamo un'azienda ceramica italiana che studia, progetta e produce in Italia pavimenti e rivestimenti in gres porcellanato.

La nostra storia, iniziata nel 1995, all'interno dello storico Gruppo Concorde, ci vede da subito protagonisti nel settore ceramico.

Oggi la nostra produzione supera i cinque milioni di metri quadri all'anno e raggiunge ottanta paesi. Crediamo nell'innovazione tecnologica e di processo, ma manteniamo l'occhio meticoloso dell'artigiano. Siamo attenti alla salute e alla sicurezza dei nostri collaboratori e da sempre l'ambiente e la sostenibilità sono alla base del nostro operato.

EN_
“Simplicity is the ultimate sophistication”
(C.B. Luce)

We are an Italian ceramic company that studies, designs and produces porcelain stoneware floor and wall tiles in Italy. Our history began in 1995 within the historical group Concorde and immediately sees us as protagonists in the ceramic industry.

Today, our production exceeds five million square metres per year across a total of eighty countries. We believe in technological and process innovation, but we keep the meticulous eye of the craftsman. We care for the health and safety of our employees; the environment and sustainability have always been the basis of our work.

FR_
“Simplicity is the ultimate sophistication”
(C.B. Luce)

Nous sommes une entreprise italienne de céramique qui fait des recherches, conçoit et produit des revêtements de sol ou de mur en grès cérame. Notre entreprise a commencé son activité en 1995, en s'appuyant appui sur la longue expérience du groupe Concorde, pour devenir rapidement l'un des protagonistes du secteur de la céramique. Aujourd'hui notre production dépasse cinq millions de mètres carrés par an, vendus dans quatre-vingt pays. Nous croyons à l'innovation technologique et des processus de production, mais nous conservons l'œil attentif de l'artisan. Nous sommes soucieux de la santé et de la sécurité de nos employés, et l'environnement et le développement durable sont depuis toujours au fondement de notre activité.

DE_
“Simplicity is the ultimate sophistication”
(C.B. Luce)

Wir sind ein italienisches Keramikunternehmen, das in Italien Boden- und Wandfliesen aus Feinsteinzeug entwirft, plant und produziert. Unsere Geschichte beginnt 1995 im historischen Konzern Concorde und stellt uns unverzüglich unter die Hauptdarsteller der Keramikindustrie. Heute überschreitet unsere Produktion fünf Millionen Quadratmeter pro Jahr und erreicht achtzig Länder. Wir glauben an Technologie- und Prozessinnovationen, aber das Handwerk ist und bleibt an erster Stelle. Wir achten auf die Gesundheit und Sicherheit unserer Mitarbeiter. Umwelt und Nachhaltigkeit waren schon immer die Grundlage unserer Arbeit.

ES_
“Simplicity is the ultimate sophistication”
(C.B. Luce)

Somos una empresa de cerámica italiana que investiga, diseña y fabrica suelos y revestimientos de gres porcelánico en Italia. Desde nuestros comienzos en 1995 como parte del histórico grupo Concorde, pronto nos convertimos en protagonistas en el sector de la cerámica. Nuestra producción supera en la actualidad los cinco millones de metros cuadrados al año y llega a ochenta países. Creemos en la innovación tecnológica y de procesos, sin renunciar por ello a la meticulosidad de la elaboración artesanal. Prestamos atención a la salud y a la seguridad de nuestros colaboradores, siendo el medio ambiente y la sostenibilidad aspectos básicos de nuestro trabajo desde siempre.

GRES PORCELLANATO

PORCELAIN STONEWARE / GRÈS CÉRAME / FEINSTEINZEUG / GRES PORCELÁNICO



IT_

Mentre tutto cambia, i pavimenti e rivestimenti in gres porcellanato restano le fondamenta a vista di uno spazio. Per composizione mineralogica e processo produttivo, i nostri prodotti non temono infatti alterazioni ed aggressioni come gli urti, le abrasioni, il fuoco, il gelo, l'umidità, il peso, il clima e conservano nel tempo il colore e l'aspetto del primo giorno.

La nostra ceramica non emette sostanze organiche, non alimenta allergie e si lascia pulire con semplicità. La qualità e la bellezza ottenuti sono il frutto di investimenti in tecnologia e di un fortissimo impegno volto a sviluppare prodotti ad alto contenuto estetico.

EN_

While everything changes, porcelain stoneware floors and walls remain the visible foundation of a space. Thanks to their mineralogical composition and production process, our products do not fear alterations and aggressions such as impacts, abrasions, fire, frost, moisture, weight, climate and preserve over time the colour and appearance of the first day.

Ceramic does not emit any organic substances, does not fuel allergies and is easily cleaned. The quality and beauty obtained are the result of investments in technology and a strong commitment to develop products with a high aesthetic content.

FR_

Tout le reste peut changer, mais les revêtements de sol et de mur en grès cérame restent les éléments visibles incontournables d'un espace.

En raison de leur composition chimique et de leur processus de production, nos produits ne craignent ni les altérations ni les agressions telles que des chocs, des abrasions, le feu, le gel, l'humidité, les charges ou les effets du climat et conservent leur couleur et leur aspect comme au premier jour.

Notre céramique n'émet pas de substances organiques, ne provoque pas d'allergies et se nettoie facilement. La qualité et la beauté de nos produits sont le fruit d'investissements technologiques et de notre forte volonté pour développer des produits de très grande qualité esthétique.

DE_

Während sich alles ändert, bleiben Boden- und Wandfliesen aus Feinsteinzeug das sichtbare Fundament eines Raumes.

Aufgrund ihrer mineralogischen Zusammensetzung und ihres Herstellungsprozesses unterliegen sie weder Änderungen noch Angriffen. Sie scheuen weder Stöße, Abrieb, Feuer, Frost, Feuchtigkeit, Belastung noch klimatische Beanspruchungen und bewahren mit der Zeit die Farbe und das Aussehen des ersten Tages.

Unsere Keramik gibt keine organischen Stoffe ab, bewirkt keine Allergien und lässt sich leicht reinigen. Die erzielte Qualität und Schönheit sind das Ergebnis von Investitionen in die Technologie und einem starken Engagement für die Entwicklung von Produkten mit hohem ästhetischen Gehalt.

ES_

Si bien todo cambia, los suelos y revestimientos de gres porcelánico siguen siendo los cimientos visibles de cualquier espacio.

Por composición mineralógica y proceso de producción, nuestros productos no se ven afectados por alteraciones y agresiones (como golpes, abrasiones, fuego, heladas, humedad, peso y clima) y conservan el color y el aspecto del primer día a lo largo del tiempo.

Nuestra cerámica no emite sustancias orgánicas, no provoca alergias y se puede limpiar fácilmente. Su calidad y atractivo son fruto de inversiones en tecnología y de un importante compromiso con el desarrollo de productos de alto contenido estético.

GRES PORCELLANATO

PORCELAIN STONEWARE / GRÈS CÉRAMÉ / FEINSTEINZEUG / GRES PORCELÁNICO

outstanding performance



ANTISDRUCCIOLO /

ANTI-SLIP / ANTIDÉRAPANT /
RUTSCHFESTIGKEIT / ANTIDESLIZANTE

per ambienti bagnati e outdoor /
for outdoor and wet environments /
pour sols mouillés et en extérieur / für die
Verlegung im Nass- und Außenbereich
geeignet / para ambientes mojados y de
exterior



STABILE CROMATICAMENTE /

CHROMATICALLY FAST / COULEURS STABLES /
FARBSTABIL / CROMÁTICAMENTE ESTABLE

inalterabile da agenti atmosferici e smog /
unchanged by weather agents and smog / inaltérable
face aux agents atmosphériques et à la pollution /
gegen Witterungseinflüsse und Smog widerständig /
no se ve afectado por los agentes atmosféricos ni la
polución



FACILMENTE PULIBILE /

EASY TO CLEAN / FACILE À NETTOYER /
REINIGUNGSFREUNDLICH /
DE FÁCIL LIMPIEZA



RESISTENTE A SFORZI ED ABRASIONI /

RESISTANT TO STRESSES AND ABRASION / RÉSISTANT AUX
CONTRAINTE ET ABRASIONS / BESTÄNDIG GEGEN
TIEFENVERSCHLEISS UND STARKE BEANSPRUCHUNG /
RESISTENTE A LOS ESFUERZOS Y A LA ABRASIÓN

500 Kg/cm² di pressatura meccanica e cottura a 1.250°C /
500 kg/cm² of mechanical pressing and firing at 1250°C / 500 kg/cm² de
pressage mécanique et cuisson à 1.250 °C / 500 kg/cm² mechanische
Presskraft und Brand bei 1.250°C / 500 kg/cm² de prensado mecánico y
cocción a 1.250 °C



NON REAGISCE AL FUOCO /

DOES NOT REACT TO FIRE / NE RÉAGIT PAS AU FEU /
FEUERBESTÄNDIG / NO REACCIONA AL FUEGO

non emette fumi in caso di incendio /
does not release fumes in case of fire /
n'émet pas de fumée en cas d'incendie /
erzeugt im Brandfall keinen Rauch /
no emite humo en caso de incendio



ASSORBIMENTO H₂O NULLO /

NULL H₂O ABSORPTION / ABSORPTION H₂O NULLE
/ KEINE WASSERAUFNAHME / NULA ABSORCIÓN
DE H₂O



INATTACCABILE DA ACIDI /

NOT ATTACKED BY ACIDS / IMPERMÉABLE
CONTRE LES ACIDES / SÄUREBESTÄNDIG /
RESISTENTE A LOS ÁCIDOS



RESISTENTE A GELO E SHOCK TERMICI /

RESISTANT TO FROST AND SUDDEN THERMAL CHANGES /
RESISTANT AU GEL ET AUX CHOCS THERMIQUES / HÄLT FROST UND
HITZESCHOCKS STAND / RESISTENTE A LAS HELADAS Y AL CHOQUE
TÉRMICO

MADE IN ITALY

MADE IN ITALY / MADE IN ITALY / MADE IN ITALY / MADE IN ITALY

IT_

Con il nostro lavoro svolto interamente nel distretto ceramico italiano rinnoviamo ogni giorno il prestigio antico del patrimonio Made in Italy.

Desideriamo offrire collezioni originali, curate nel dettaglio sia in fase progettuale che produttiva. Le idee nascono dalla passione per il nostro lavoro e siamo spinti dal desiderio di offrire qualità e bellezza a chi sceglie i nostri prodotti. La nostra filosofia, nel lavoro di tutti i giorni, si può riassumere in cura del dettaglio, responsabilità sociale, rispetto per l'ambiente e per le persone, valori che da sempre ci contraddistinguono, per portare l'unicità del Made in Italy nel mondo.

EN_

With our work carried out entirely within the Italian ceramic district we renew every day the ancient prestige of the Made in Italy heritage.

We want to offer original collections, with attention to detail both in the design and production phases. Ideas generate from the passion for our work and we are driven by the desire to offer quality and beauty to those who choose our products. In our daily work, our philosophy can be summed up in attention to detail, social responsibility, respect for the environment and for people, values that have always distinguished us, to bring the uniqueness of Made in Italy in the world.

FR_

Notre production de céramique entièrement réalisée dans le district céramique italien célèbre chaque jour le prestige de la tradition du patrimoine Made in Italy.

Nous voulons offrir des collections originales, soignées dans les détails dès leur conception et jusqu'à leur production. Nos idées sont générées par notre passion pour notre travail et c'est le désir d'offrir qualité et esthétique à nos clients qui nous porte.

La philosophie de notre travail de tous les jours peut se résumer par le soin des détails, notre responsabilité sociale et notre respect de l'environnement et des personnes : des valeurs qui nous distinguent depuis toujours pour exporter les qualités uniques du Made in Italy partout dans le monde.

DE_

Mit unserer Arbeit, die vollständig innerhalb des italienischen Keramikviertels durchgeführt wird, erneuern wir jeden Tag das alte Prestige des Made in Italy.

Wir wollen Originalkollektionen anbieten, die sowohl in der Design- als auch in der Produktionsphase mit viel Liebe zum Detail gestaltet werden. Ideen entstehen aus der Leidenschaft für unsere Arbeit und wir sind von dem Wunsch getrieben, Qualität und Schönheit denjenigen zu bieten, die sich für unsere Produkte entscheiden.

Unsere Philosophie, in unserer täglichen Arbeit, lässt sich in Liebe zum Detail, sozialer Verantwortung, Respekt vor der Umwelt und den Menschen zusammenfassen, Werte, die uns seit jeher auszeichnen, um die Einzigartigkeit des Made in Italy auf der Welt zu verbreiten.

ES_

Con nuestro trabajo, que desarrollamos por entero en el distrito de la cerámica de Italia, cada día renovamos el antiguo prestigio del patrimonio Made in Italy.

Nuestro deseo es ofrecer colecciones originales, con detalles cuidados tanto en la fase de diseño como durante la producción. Las ideas nacen de la pasión por nuestro trabajo y nuestro incentivo es el deseo de ofrecer calidad y belleza a quien elige nuestros productos.

Nuestra filosofía, que rige el trabajo diario, se puede resumir en estos valores: atención al detalle, responsabilidad social, respeto por el medio ambiente y las personas, valores que nos distinguen desde siempre como abanderados de la exclusividad del Made in Italy en el mundo.



GREENTHINKING

GREENTHINKING / GREENTHINKING / GREENTHINKING / GREENTHINKING

EPD

FDES
VÉRIFIÉE

LEED
COMPLIANT

PEF

CAM
COMPLIANT

HPD



IT_

Il rispetto per l'ambiente è impegno di ogni giorno, fatto di gesti semplici e di progetti per guardare lontano. Il primo dovere è non sprecare acqua, per questo recuperiamo tutta quella che utilizziamo. Riduciamo sensibilmente il consumo di materie prime in produzione recuperando tutti i materiali di scarto derivanti dalle lavorazioni. Per ridurre l'emissione di CO₂ nell'aria, autoproduciamo la maggior parte dell'energia elettrica con impianti di cogenerazione. Impieghiamo pallet fao per ridurre il rischio della diffusione di organismi nocivi nei mercati in cui esportiamo. Questo è solo parte del nostro impegno, una responsabilità quotidiana per tutelare l'ambiente, la nostra casa. Siamo fieri delle numerose certificazioni ottenute: testimoniano un modo di agire e pensare quotidiano, nel rispetto di chi lavora con noi e di chi sceglie con fiducia i nostri prodotti.

EN_

The respect for the environment is a daily commitment, made up of simple gestures and more long-term projects. Our first goal is to not waste water, and so we recover all that we use. We significantly reduce the consumption of raw materials in production by recovering all waste materials resulting from processing. In order to reduce carbon dioxide emissions, we produce most of our own electrical energy by ourselves, with cogeneration plants. We use FAO pallets to reduce the risk of spreading harmful organisms in the markets to which we export. This is only part of our commitment, a daily responsibility to protect the environment, our home. We are proud of the numerous certifications we have obtained: they are the proof of a daily way of acting and thinking, respecting those who work with us and those who choose our products with confidence.

FR_

Le respect de l'environnement est un engagement quotidien, fait de gestes simples et de projets qui voient loin. Le premier devoir est de ne pas gaspiller l'eau et, pour cela, nous récupérons toute l'eau que nous utilisons. Nous avons réduit de manière sensible la consommation de matières premières en récupérant tous les matériaux normalement éliminés, issus des étapes de la fabrication. Pour réduire nos émissions de dioxyde de carbone, nous autoproduisons la majeure partie de l'énergie électrique que nous consommons avec des installations de co-génération. Nous utilisons des palettes FAO pour diminuer les risques de diffusion d'organismes nocifs dans nos marchés d'exportation. Ceci n'est que l'un des aspects de notre engagement et de notre responsabilité quotidienne pour la protection de l'environnement et de notre habitat. Nous sommes fiers des nombreuses certifications que nous avons obtenues: elles témoignent de notre manière quotidienne d'agir et de penser, dans le respect de ceux qui travaillent avec nous et des clients qui font confiance à nos produits.

DE_

Umweltschutz ist eine tägliche Verpflichtung, die sich aus einfachen Gesten und Projekten zusammensetzt, um weit in die Zukunft blicken zu können. Unsere erste Pflicht ist es, kein Wasser zu verschwenden, deshalb recyceln wir alles, was wir verbrauchen. Durch die Rückgewinnung aller bei der Verarbeitung anfallenden Abfälle reduzieren wir den Verbrauch von Rohstoffen in der Produktion deutlich. Um die Emission von Kohlenmonoxid in die Luft zu reduzieren, produzieren wir den größten Teil der elektrischen Energie selbst mit KWK-Kraftwerken. Wir verwenden FAO-Paletten, um das Risiko der Ausbreitung von Schadorganismen in den Märkten, in die wir exportieren, zu verringern. Dies ist nur ein Teil unseres Engagements, eine tägliche Verantwortung für den Schutz der Umwelt, die wir bewohnen. Wir sind stolz auf die zahlreichen Zertifizierungen, die wir erhalten haben: Sie zeugen von einem täglichen Handeln und Denken, das diejenigen respektiert, die mit uns arbeiten und diejenigen, die unsere Produkte mit Vertrauen wählen.

ES_

El respeto del medio ambiente es un compromiso diario, compuesto de gestos sencillos y proyectos para mirar al futuro. Ante todo no hay que desperdiciar el agua, por lo que recuperamos toda la que usamos. Reducimos considerablemente el consumo de materias primas durante la producción y recuperamos todos los materiales de desecho derivados de estos procesos. Para reducir las emisiones de monóxido de carbono en el aire, autoproducimos la mayor parte de la energía eléctrica con plantas de cogeneración. Además, utilizamos palés FAO para reducir el riesgo de propagación de plagas en los mercados a los que exportamos. Esto no solo forma parte de nuestro compromiso, sino también de la responsabilidad de proteger el medio ambiente a diario, que es nuestra casa. Nos sentimos orgullosos de las certificaciones obtenidas, que dan testimonio de un modo de pensar y de obrar cotidiano, basado en el respeto de las personas que trabajan con nosotros y confían en nuestros productos.

GREENTHINKING

GREENTHINKING / GREENTHINKING / GREENTHINKING / GREENTHINKING

outstanding responsibility



* 18.408 t = 570 

MATERIE PRIME NON ESTRATTE GRAZIE AL RECUPERO DI SCARTI /

NON-EXTRACTED RAW MATERIALS THANKS TO THE
RECOVERY OF SCRAPS / MATIÈRES PREMIÈRES NON
EXTRAITES GRÂCE AU RECYCLAGE DES DÉCHETS / DURCH
DIE VERWERTUNG VON AUSSCHUSSMATERIAL RECYCELTE
ROHSTOFFE / MATERIAS PRIMAS NO EXTRAÍDAS, GRACIAS A
LA RECUPERACIÓN DE DESECHOS



100% SCARTI CRUDI RECUPERATI /

100% RECOVERED RAW SCRAPS / 100 % DES
DÉCHETS CRUS RECYCLÉS / 100% WIEDERVERWER-
TETES, ROHES AUSSCHUSSMATERIAL / 100% DE
LOS DESECHOS SIN COCER RECUPERADOS



100% ACQUE REFLUE RECUPERATE /

100% RECOVERED WASTE WATER / 100 % DES EAUX
USÉES RECYCLÉES / 100% RÜCKGEWONNENES
ABWASSER / 100% DE LAS AGUAS RESIDUALES
RECUPERADAS



* + 5.000.000 L = 3.000.000 

ACQUE DI PROCESSO DA ALTRI STABILIMENTI /

PROCESS WATER FROM OTHER FACTORIES / EAUX DE
PROCÉDÉ PROVENANT D'AUTRES USINES /
PROZESSWASSER AUS ANDEREN WERKEN / AGUAS DE
PROCESAMIENTO DE OTRAS FÁBRICAS



* + 24.000 MWh/year = 185.000 

84% ENERGIA AUTO PRODOTTA DA IMPIANTI DI COGENERAZIONE /

84% ENERGY SELF-PRODUCED BY COGENERATION PLANTS
/ 84 % DE L'ÉNERGIE AUTOPRODUITE PAR SYSTÈMES DE
COGÉNÉRATION / 84% MIT BHK-ANLAGEN SELBSTERZEUGTE
ENERGIE / 84% DE LA ENERGÍA AUTOPRODUCIDA POR
INSTALACIONES DE COGENERACIÓN



ENERGIA AUTO PRODOTTA DA FOTOVOLTAICO /

ENERGY SELF-PRODUCED BY PV PLANT / ÉNERGIE
AUTOPRODUITE PAR PHOTOVOLTAÏQUE /
MIT FV-ANLAGEN SELBSTERZEUGTE ENERGIE /
ENERGÍA AUTOPRODUCIDA POR INSTALACIONES
FOTOVOLTAICAS



98% RIFIUTI AVVIATI A RACCOLTA DIFFERENZIATA /

98% WASTE SENT TO SEPARATE COLLECTION / 98 %
DES DÉCHETS ENVOYÉS À LA COLLECTE SÉPARÉE
/ 98% DER ABFÄLLE WERDEN DER GETRENNTEN
SAMMLUNG ZUGEFÜHRT / 98% DE LOS RESIDUOS
ENVIADOS A RECOGIDA SELECTIVA



100% PALLET FAO /

100% FAO PALLETS / 100 % PALETTES FAO /
100% FAO-PALETTEN / 100% PALETS FAO

* Dati riferiti al 2018 / Data referring to year 2018 / Données se référant à l'année 2018 /

Angaben beziehen sich auf das Jahr 2018 / Datos referentes al año 2018

PROGETTI

PROJECTS / PROJETS / PROJEKTE / PROYECTOS

IT_

**“Nothing is more difficult than making something look simple”
(D. Collins, Architetto)**

Le nostre collezioni sono protagoniste di ambienti interni ed esterni, in tutto il mondo. Attraverso la nostra proposta di prodotto, desideriamo soddisfare le esigenze dell'architettura moderna e del design più raffinato, rendendo la progettazione stimolante ed offrendo ogni volta sempre nuovi spunti creativi. Le nostre collezioni, ricche di formati e finiture e caratterizzate da ricercate sfumature di colore, permettono ai progettisti di realizzare spazi visivamente stimolanti, confortevoli e belli da vivere. L'interazione esatta tra forme e materiali è frutto di strategia e ricerca: sono i primi strumenti per valorizzare le scelte architettoniche senza perdere di vista l'impatto ambientale. Ogni creazione è una sintesi inedita di scelte minuziose, per risultati singolari in termini di tecnica ed estetica.

EN_

**“Nothing is more difficult than making something look simple”
(D. Collins, Architect)**

Our collections are protagonists of indoor and outdoor environments, all over the world. Through our product proposal, we want to meet the needs of modern architecture and the most refined design, making the design stimulating and always offering new creative ideas. Our collections, rich in sizes and finishes and characterized by refined shades of colour, allow designers to create visually stimulating spaces, comfortable and beautiful to live in. The exact interaction between shapes and materials is the result of strategy and research: they are the first tools to enhance the architectural choices without forgetting the environmental impact. Each creation is a unique blend of well-reasoned choices, for unique results, both technical and aesthetic.

FR_

**“Nothing is more difficult than making something look simple”
(D. Collins, Architect)**

Nos collections sont à l'honneur dans des espaces intérieurs ou extérieurs, partout dans le monde. Notre offre de produits vise à satisfaire les exigences de l'architecture moderne et du design le plus recherché, en stimulant la conception tout en proposant chaque fois de nouvelles idées originales. Nos collections offrent de nombreux formats et types de finitions, selon une gamme de nuances colorées recherchées, qui permet aux designers de créer des espaces visuellement stimulant, confortables et agréables à vivre. L'interaction exacte entre les formes et les matériaux est le fruit de la stratégie et de la recherche : ce sont les principaux outils permettant de valoriser les choix architecturaux sans perdre de vue l'impact environnemental. Chaque création est une synthèse inédite de choix minutieux, pour des résultats exemplaires en termes de technique et d'esthétique.

DE_

**“Nothing is more difficult than making something look simple”
(D. Collins, Architect)**

Unsere Kollektionen sind Protagonisten des Innen- und Außenbereichs auf der ganzen Welt. Mit unserem Produktvorschlag wollen wir den Bedürfnissen der modernen Architektur und dem raffiniertesten Design gerecht werden, das das Design anregend macht und immer wieder neue kreative Ideen bietet. Unsere Kollektionen, die reich an Größen und Ausführungen sind und sich durch raffinierte Farbtöne auszeichnen, ermöglichen es Designern, visuell stimulierende Räume zu schaffen, in denen man bequem und schön wohnen kann. Die genaue Interaktion zwischen Formen und Materialien ist das Ergebnis von Strategie und Forschung: Sie sind die ersten Werkzeuge, die architektonische Entscheidungen verbessern, ohne die Umweltauswirkungen aus den Augen zu verlieren. Jede Kreation ist eine neue Synthese aus sorgfältigen Entscheidungen, für außerordentliche Ergebnisse in Bezug auf Technik und Ästhetik.

ES_

**“Nothing is more difficult than making something look simple”
(D. Collins, Architect)**

Nuestras colecciones son protagonistas de interiores y exteriores en el mundo entero. Con nuestra oferta de producto queremos satisfacer las necesidades de la arquitectura moderna y del diseño más sofisticado para que el diseño siga siendo una actividad apasionante y siempre haya cabida para las ideas creativas. Nuestras colecciones, pródigas en formatos y acabados, además de estar caracterizadas por sofisticados matices de color, permiten a los diseñadores realizar espacios para vivir visualmente estimulantes, cómodos y hermosos. La interacción exacta entre formas y materiales es el resultado de la estrategia y la investigación: son las primeras herramientas para resaltar las decisiones arquitectónicas sin perder de vista el impacto ambiental. Cada creación es una síntesis inédita de elecciones minuciosas, para resultados singulares en términos de técnica y estética.



PROGETTI

PROJECTS / PROJETS / PROJEKTE / PROYECTOS

bar&restaurant

Project: Manunzio Bar
Designer: Koinè Design
Collections: Elements Lux



Photos: Luciano Busani

Project: Ristorante La Guardia Hotel
Designer: Flavio Caprabanca
Collections: Moov



Photos: Luciano Busani

Project: La Maison du Gourmet
Designer: Arch. Scalfone
Collections: Percorsi Extra



Photos: Pietro Gerboni

PROGETTI

PROJECTS / PROJETS / PROJEKTE / PROYECTOS

hotel&wellness

Project: Vinotel Gospoja
Designer: Idis Turato
Collections: Percorsi Extra



Photos: eMk Partner

Project: QC Terme Dolomiti
Collections: Percorsi Smart



Photos: Luciano Busani

Project: Hotel De La Ville
Designer: Ceramiche Pullè S.r.l.
Collections: Code



Photos: Luciano Busani

PROGETTI

PROJECTS / PROJETS / PROJEKTE / PROYECTOS

public&shop

Project: RSA Lanzo Torinese
Designer: Picco Architetti
Collections: Elements Design / Code



Photos: Picco Architetti

Project: Atelier Settebello
Collections: Elements Lux



Photos: Francesca Cannino

Project: Museo Egizio Torino
Designer: Studio Isolarchitetti
Collections: Percorsi Extra



Photos: Luciano Busani

PROGETTI

PROJECTS / PROJETS / PROJEKTE / PROYECTOS

mall&office

Project: The Style Outlets
Collections: Moov



Photos: Petr Sokol

Project: Mondo Juve Shopping Center
Designer: Arch. Davide Simonetti
Collections: Evoke / Percorsi Extra



Photos: Luciano Busani

Project: ADI S.r.l.
Designer: Minuzzo S.r.l.
Collections: Moov



Photos: Luciano Busani

PROGETTI

PROJECTS / PROJETS / PROJEKTE / PROYECTOS

residential

Project: Villa Privata
Designer: Studio Arhitektonik
Collections: Percorsi Extra K2 20mm



Photos: Mr. Milos Radivojevic

Project: Millennium Park
Collections: Percorsi Extra / Sight



Photos: Massimo Marengo

Project: Residenziale Bernini
Designer: +Studio Architetti Torino - Arch.Filippo Orlando
Collections: Code



Photos: Mario Forghero

collections

120x278 6mm range	/032
Marble effect	/036
Stone effect	/072
Concrete&Design effect	/206
Wood effect	/258
Colour effect	/282
Contract	/296
K2 20mm range	/326
K3 30mm range	/334



120x278 (48"x110")

6 mm

22

*COLORI/
COLOURS
COULEURS
FARBE
COLORES*

3

*FINITURE/
FINISHES
FINITIONS
OBERFLÄCHEN
ACABADOS*

7

*COLLEZIONI/
COLLECTIONS
COLLECTIONS
KOLLEKTIONEN
COLECCIONES*

COLORI E FINITURE

COLORS AND FINISHES / COULEURS ET FINITIONS / FARBEN UND OBERFLÄCHEN / COLORES Y ACABADOS

BRYSTONE



● Ivory

ELEMENTS DESIGN

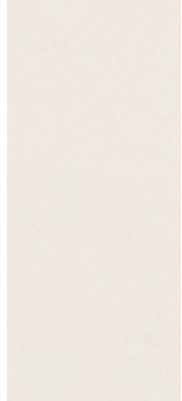

● White

MOOV

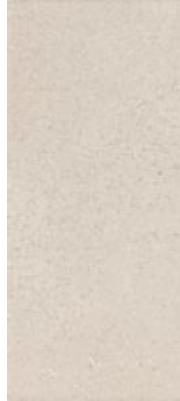

● Ivory

IKON

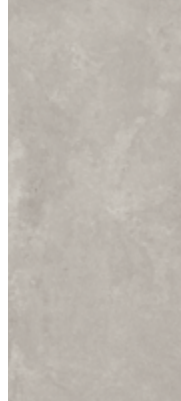

● Silver



● Gold



● Grey



● Grey



● Grey



● Beige

INTERN04

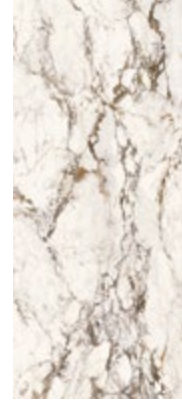

◆ Breccia Tortona

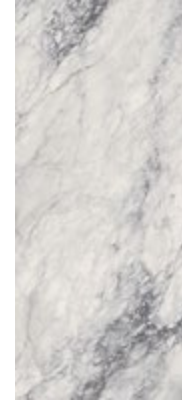

◆ Renoir Isola



◆ Calacatta San Babila



◆ Carnico Brera

ELEMENTS LUX



◆ Calacatta



◆ Silver Grey



◆ Calacatta Gold



◆ Port Laurent



◆ Emperador

ECLECTIC



◆ Oniric White

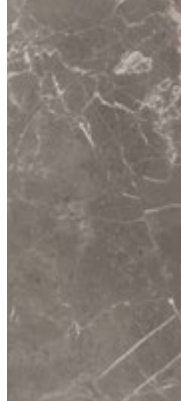

✕ Persian Grey



◆ Mistiq White



✕ Pinstripe Dark

120x278 6mm

● Natural R9 | ◆ Lappato | ✕ Silky



marble

EFFECT

038 / Interno4

050 / Eclectic

060 / Elements Lux

interno4

6

COLORI/
COLOURS
COULEURS
FARBE
COLORES

7

FORMATI/
SIZES
FORMATS
FORMATE
FORMATOS

2

SUPERFICI/
FINISHES
FINITIONS
OBERFLÄCHEN
ACABADOS

2

SPESSORI/
THICKNESS
ÉPAISSEUR
STÄRKE
ESPESOR





RENOIR ISOLA
80X80 (32"x32")



CALACATTA SAN BABILA
120x278 (48"x110") - 120x120 (48"x48")



CARNICO BRERA
120x120 (48"x48")

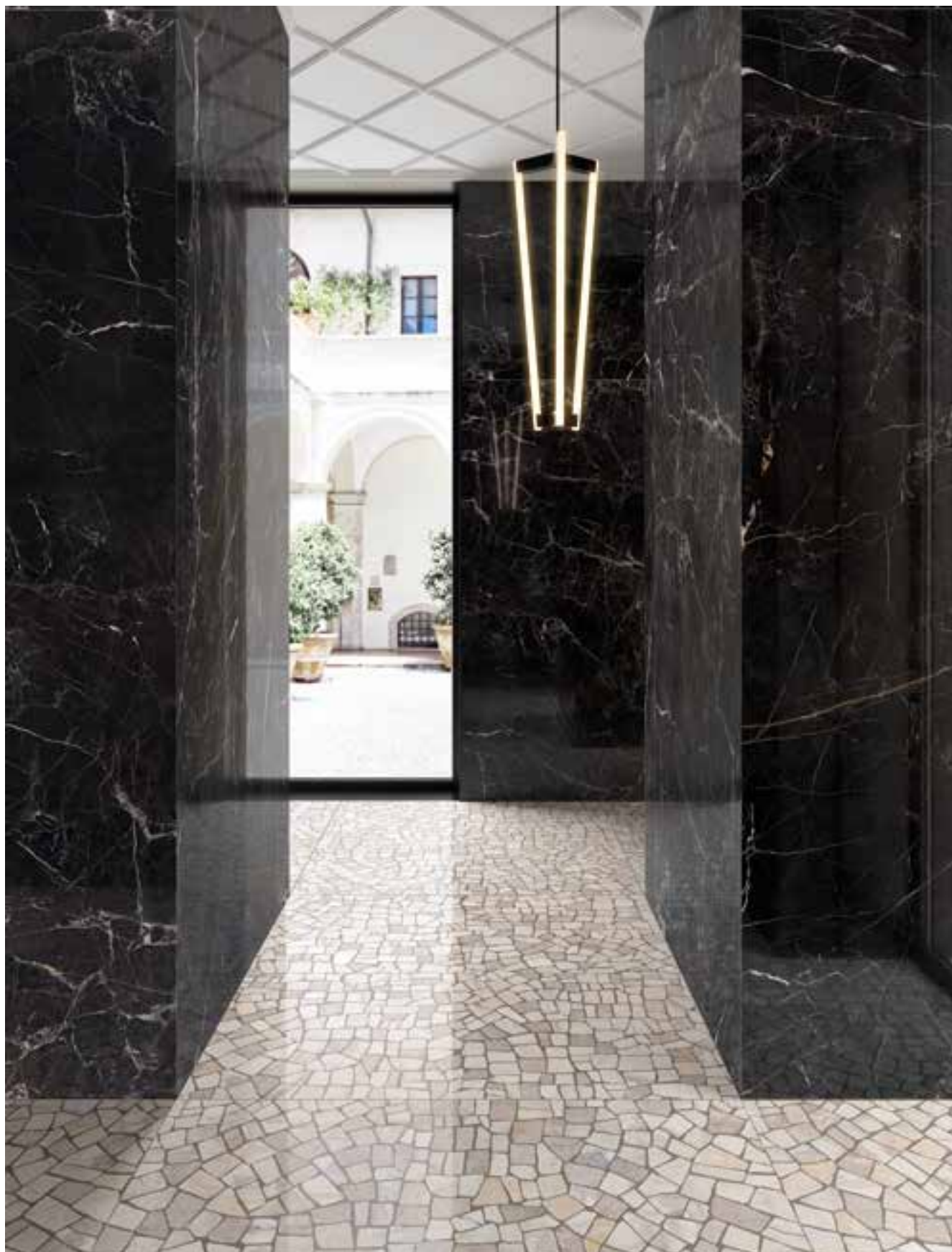

PALLADIANA LIGHT
120x120 (48"x48")

E.LUX PORT LAURENT
120X278 (48"x110")

PALLADIANA DARK
120x120 (48"x48")

6

COLORI/

COLOURS / COULEURS / FARBE / COLORES

BRECCIA TORTONA **V2**



RENOIR ISOLA **V2**



CALACATTA SAN BABILA **V2**

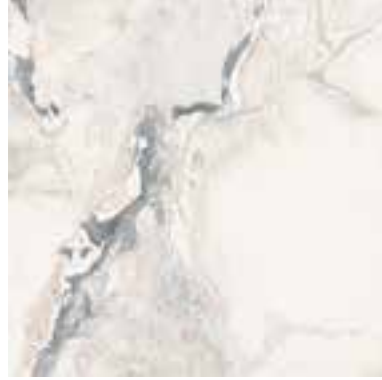

CARNICO BRERA **V3**



PALLADIANA LIGHT **V2**



PALLADIANA DARK **V2**

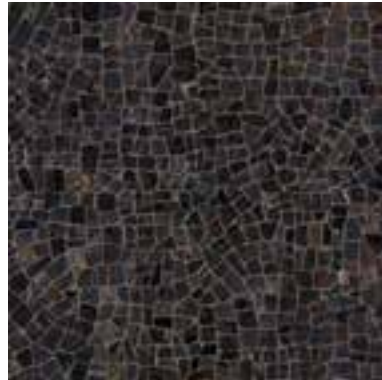

7

FORMATI/

SIZES / FORMATS / FORMATE / FORMATOS



◆ 120x278 (48"x110") RT 6 mm



◆ 80x160 (32"x64") RT 9 mm



●◆ 80x80 (32"x32") RT 9 mm

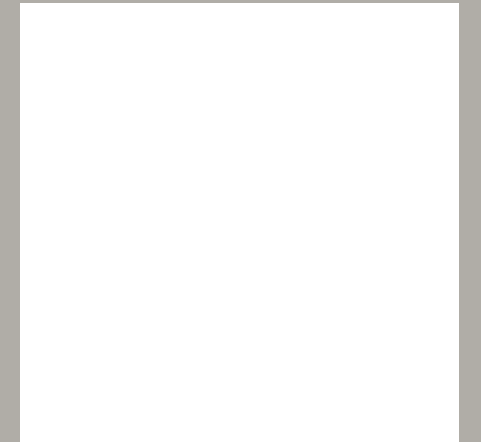

◆ 120x120 (48"x48") RT 9 mm

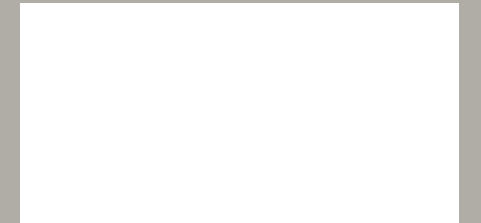

●◆ 60x120 (24"x48") RT 9 mm

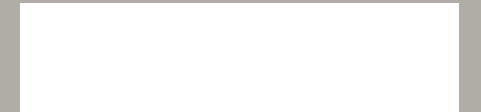

◆ 30x120 (12"x48") RT 9 mm

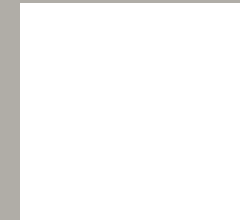

◆ 60x60 (24"x24") RT 9 mm

● Natural R9 | ◆ Lappato

marble effect | interno4

6

DECORI/

DECORS / PIECES SPECIALES / FORMTEILE /
PIEZAS ESPECIALES

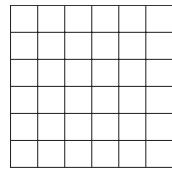

MOSAICO ◆ 30x30 (12"x12") RT 9 mm
(TESSERE: 4,8x4,8 - 17/8"x17/8")

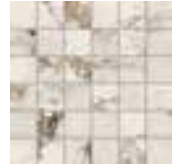

BRECCIA TORTONA

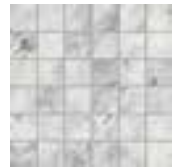

RENOIR ISOLA



CALACATTA SAN BABILA



CARNICO BRERA

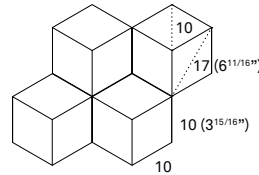

MOSAICO ROMBI
◆ 30,5x35,2 (12^{1/16}"x13^{7/8}") RT 9 mm



BRECCIA TORTONA



RENOIR ISOLA



CALACATTA SAN BABILA



CARNICO BRERA



COPRISPIGOLO*
CORNER / ELÉMENT DE REVÊTEMENT /
ABDECKELEMENTES / ELEMENTO DE COBERTURA
◆ 1x90 (26/64"x36") RT 6 mm



ANGOLARE COPRISPIGOLO*
ANGULAR CORNER / ELÉMENT DE REVÊTEMENT ANGULAIRE /
ECKE ABDECKELEMENTES / ELEMENTO DE COBERTURA ANGULAR
◆ 1x1 (26/64"x26/64") RT 6 mm

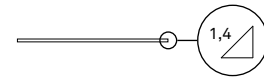

COPRISPIGOLO*
CORNER / ELÉMENT DE REVÊTEMENT /
ABDECKELEMENTES / ELEMENTO DE COBERTURA
◆ 1,4x60 (3/64"x24") RT 9 mm



ANGOLARE COPRISPIGOLO*
ANGULAR CORNER / ELÉMENT DE REVÊTEMENT ANGULAIRE /
ECKE ABDECKELEMENTES / ELEMENTO DE COBERTURA ANGULAR
◆ 1,4x1,4 (3/64"x3/64") RT 9 mm

* Disponibile in tutti i colori (no Palladiana), tagliato dal fondo /
Available in all colours (no Palladiana), cut from floor tile / Disponible
dans toutes les couleurs (no Palladiana), découpées du carrelage /
Erhältlich in allen Farben (kein Palladiana), aus Bodenfliesen
geschnitten / Disponible en todos los colores (no Palladiana),
cortado de baldosas.

6

PEZZI SPECIALI/

TRIMS / PIECES SPECIALES / FORMTEILE /
PIEZAS ESPECIALES



BATTISCOPA
BULLNOSE / PLINTHE / SOCKEL / RODAPIÉ
◆ 4,6x120 (1^{13/16}"x48") RT 9 mm
◆ 7x80 (2^{3/4}"x32") RT 9 mm

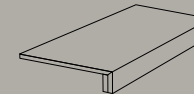

SCALINO INCOLLATO
GLUED STEP TREAD / NEZ DE MARCHE COLLÉ /
GEKLEBTE STUFENPLATTE / PELDAÑO CON PERFIL PEGADO
◆ 33x60 (13"x24") RT 9 mm

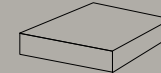

ANGOLARE INCOLLATO
GLUED CORNER STEP TREAD / CARREAU DE MARCHE COLLÉ
PIÈCE ANGULAIRE / GEKLEBTE STUFENPLATTE ECKSTÜCK /
PELDAÑO ESQUINA CON PERFIL PEGADO
◆ 33x33 (13"x13") RT 9 mm

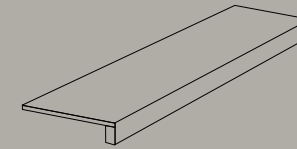

SCALINO INCOLLATO
GLUED STEP TREAD / NEZ DE MARCHE COLLÉ /
GEKLEBTE STUFENPLATTE / PELDAÑO CON PERFIL PEGADO
◆ 33x120 (13"x48") RT 9 mm

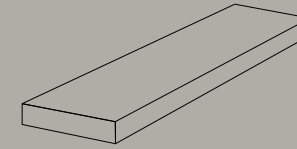

ANGOLARE INCOLLATO
GLUED CORNER STEP TREAD / CARREAU DE MARCHE COLLÉ
PIÈCE ANGULAIRE / GEKLEBTE STUFENPLATTE
ECKSTÜCK / PELDAÑO ESQUINA CON PERFIL PEGADO
◆ 33x120 (13"x48") RT 9 mm

FORMATI

SIZES / FORMATS / FORMATE / FORMATOS

	120x278 (119,5x278)* 48"x110"	80x160 (80x159,2)* 32"x64"	120x120 (119,5x119,5)* 48"x48"	60x120 24"x48"	30x120 12"x48"	80x80 32"x32"	60x60 24"x24"
working size	1194x2778	795x1592	1194x1194	596x1195	297x1195	795x795	596x596
	RT	RT	RT	RT	RT	RT	RT
	6 mm	9 mm	9 mm	9 mm	9 mm	9 mm	9 mm
BRECCIA TORTONA	◆	◆	◆	●◆	◆	●◆	
RENOIR ISOLA	◆	◆	◆	●◆	◆	●◆	
CALACATTA SAN BABILA	◆	◆	◆	●◆	◆	●◆	
CARNICO BRERA	◆	◆	◆	●◆	◆	●◆	
PALLADIANA DARK			◆				◆
PALLADIANA LIGHT			◆				◆

*Formato nominale / Nominal size / Format nominal / Nennformat / Formato nominal

● Natural R9 ◆ Lappato

eclectic

4

COLORI/
COLOURS
COULEURS
FARBE
COLORES

6

FORMATI/
SIZES
FORMATS
FORMATE
FORMATOS

3

SUPERFICI/
FINISHES
FINITIONS
OBERFLÄCHEN
ACABADOS

2

SPESSORI/
THICKNESS
ÉPAISSEUR
STÄRKE
ESPEJOR





PERSIAN GREY
120x278 (48"x110") - 60x120 (24"x48")



PINSTRIPED DARK
120x278 (48"x110")

marble effect | eclectic



MISTIQU WHITE
120x278 (48"x110") - 120x120 (48"x48")

4

COLORI/
COLOURS / COULEURS / FARBE / COLORES

ONIRIC WHITE **V2**



MISTIQ WHITE **V2**



PINSTRIPED DARK **V2**

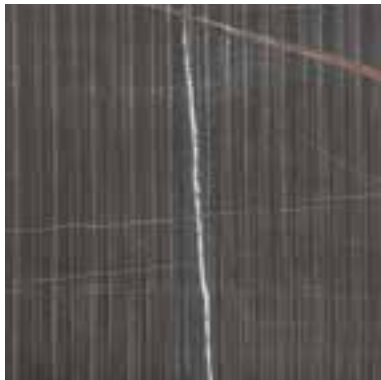

PERSIAN GREY **V2**

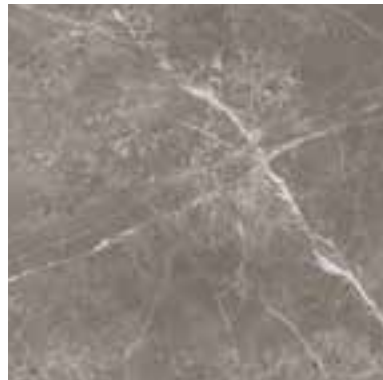

6

FORMATI/
SIZES / FORMATS / FORMATE / FORMATOS

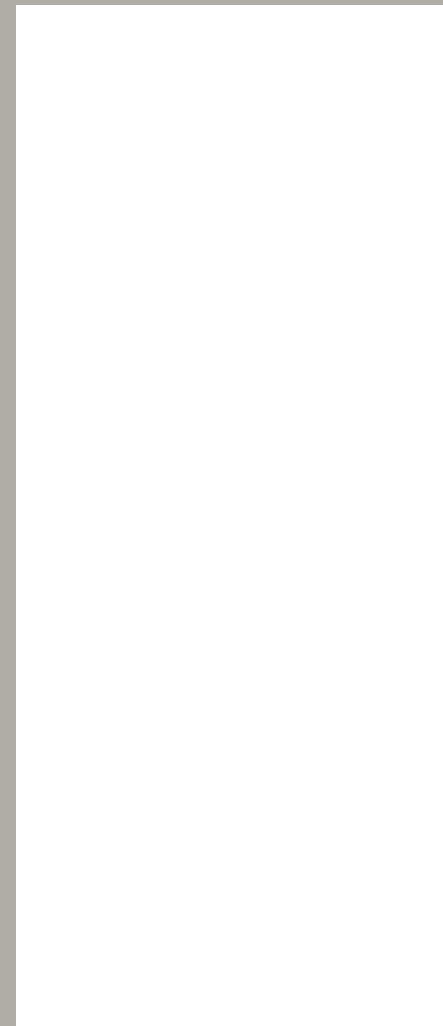

◆ X 120x278 (48"x110") RT 6 mm

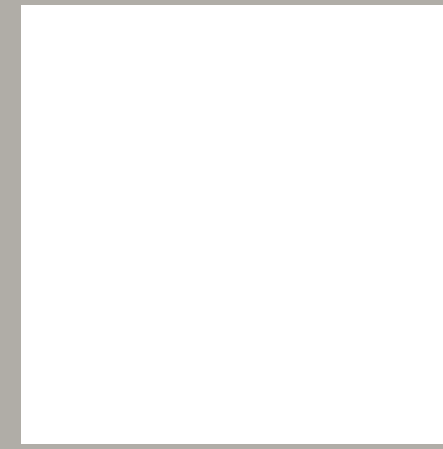

◆ X 120x120 (48"x48") RT 9 mm

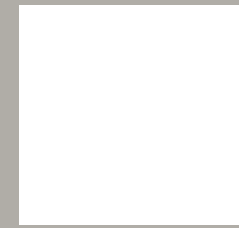

●◆ X 60x60 (24"x24") RT 9 mm



●◆ X 30x60 (12"x24") RT 9 mm

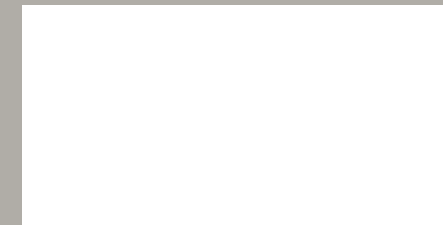

●◆ X 60x120 (24"x48") RT 9 mm



◆ X 30x120 (12"x48") RT 9 mm

● Natural R9 | ◆ Lappato | X Silky

marble effect | eclectic

2

DECORI/

DECORS / PIECES SPECIALES / FORMTEILE /
PIEZAS ESPECIALES

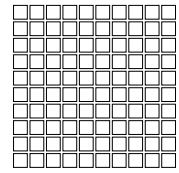

MOSAICO ◆× 30x30 (12"x12") RT 9 mm
(TESSERE: 2,8x2,8 - 1 1/8"x1 1/8")



ONIRIC WHITE



MISTIQ WHITE



PERSIAN GREY



PINSTRIPE DARK

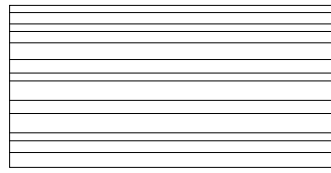

NEXT ●× 30x60 (12"x24") RT 12 mm



ONIRIC WHITE



MISTIQ WHITE



PERSIAN GREY

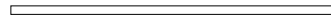

BACCHETTA GOLD ● 0,5x60 (3/16"x24") RT 8 mm

5

PEZZI SPECIALI/

TRIMS / PIECES SPECIALES / FORMTEILE /
PIEZAS ESPECIALES

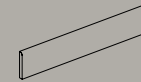

BATTISCOPA
BULLNOSE / PLINTHE / SOCKEL / RODAPIÉ
●◆× 7,2x60 (2.8"x24") RT 9 mm

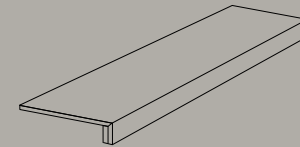

SCALINO INCOLLATO
GLUED STEP TREAD / NEZ DE MARCHE COLLÉ /
GEKLEBTE STUFENPLATTE / PELDAÑO CON PERFIL PEGADO
◆× 33x120 (13"x48") RT 9 mm

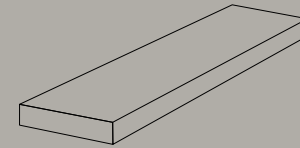

ANGOLARE INCOLLATO
GLUED CORNER STEP TREAD / CARREAU DE MARCHE COLLÉ
PIÈCE ANGULAIRE / GEKLEBTE STUFENPLATTE ECKSTÜCK /
PELDAÑO ESQUINA CON PERFIL PEGADO
◆× 33x120 (13"x48") RT 9 mm

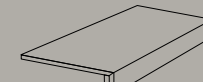

SCALINO INCOLLATO
GLUED STEP TREAD / NEZ DE MARCHE COLLÉ /
GEKLEBTE STUFENPLATTE / PELDAÑO CON PERFIL PEGADO
◆× 33x60 (13"x24") RT 9 mm

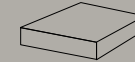

ANGOLARE INCOLLATO
GLUED CORNER STEP TREAD / CARREAU DE MARCHE COLLÉ
PIÈCE ANGULAIRE / GEKLEBTE STUFENPLATTE ECKSTÜCK /
PELDAÑO ESQUINA CON PERFIL PEGADO
◆× 33x33 (13"x13") RT 9 mm

FORMATI

SIZES / FORMATS / FORMATE / FORMATOS

	120x278 (119,5x278)* 48"x110"	120x120 (119,5x119,5)* 48"x48"	60x120 24"x48"	30x120 12"x48"	60x60 24"x24"	30x60 12"x24"
working size	1194x2778	1194x1194	596x1195	297x1195	596x596	297x596
	RT	RT	RT	RT	RT	RT
	6 mm	9 mm	9 mm	9 mm	9mm	9 mm
ECLECTIC ONIRIC WHITE	◆	◆	●◆	◆	●◆	●◆
ECLECTIC MISTIQ WHITE	◆	◆	●◆	◆	●◆	●◆
ECLECTIC PERSIAN GREY	×	×	×	×	×	×
ECLECTIC PINSTRIPE DARK	×	×	×	×	×	×

*Formato nominale / Nominal size / Format nominal / Nennformat / Formato nominal

● Natural R9 | ◆ Lappato | × Silky

elements lux

7

COLORI/
COLOURS
COULEURS
FARBE
COLORES

7

FORMATI/
SIZES
FORMATS
FORMATE
FORMATOS

2

SUPERFICI/
FINISHES
FINITIONS
OBERFLÄCHEN
ACABADOS

2

SPESSORI/
THICKNESS
ÉPAISSEUR
STÄRKE
ESPEJOR





ELEMENTS LUX CALACATTA
120x240 (48"x96")

ELEMENTS DESIGN 3D WHITE
50x110 (20"x44")



ELEMENTS LUX EMPERADOR
120x178 (48"x110")

ELEMENTS DESIGN BEIGE
120x120 (48"x48")



ELEMENTS LUX PORT LAURENT
120x278 (48"x110") - 60x120 (24"x48")

ELEMENTS LUX SILVER GREY
120x278 (48"x110") - 60x120 (24"x48")



marble effect | elements lux

7 COLORI/ COLOURS / COULEURS / FARBE / COLORES

E. LUX CALACATTA V2



E. LUX SILVER GREY V2



E. LUX CALACATTA GOLD V2



E. LUX PORT LAURENT V2



E. LUX CREMA BEIGE V2



E. LUX EMPERADOR V2



E. LUX LINCOL V1

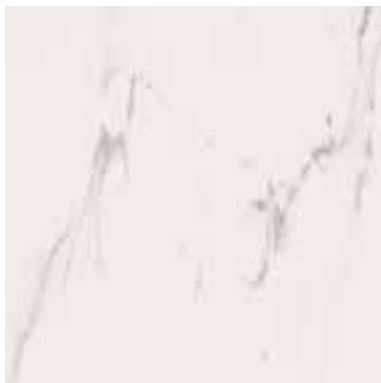

7 FORMATI/ SIZES / FORMATS / FORMATE / FORMATOS



◆ 120x278 (48"x110") RT 6 mm



◆ 120x240 (48"x96") RT 9 mm



◆ 120x120 (48"x48") RT 9 mm

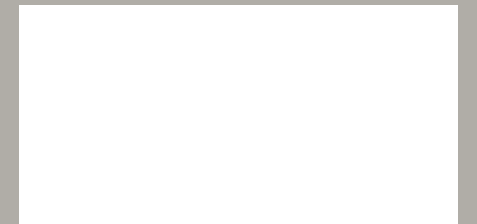

●◆ 60x120 (24"x48") RT 9 mm



◆ 20x120 (8"x48") RT 9 mm

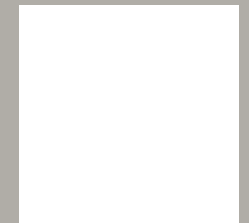

●◆ 60x60 (24"x24") RT 9 mm



●◆ 30x60 (12"x24") RT 9 mm

marble effect | elements lux

● Natural R9 | ◆ Lappato

3

DECORI/

DECORS / PIECES SPECIALES / FORMTEILE /
PIEZAS ESPECIALES

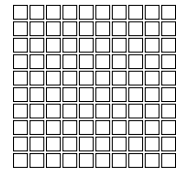

MOSAICO ◆ 30x30 (12"x12") RT 9 mm
(TESSERE: 2,8x2,8 - 1 1/8"x1 1/8")



CALACATTA



SILVER GREY

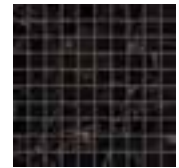

PORT LAURENT



CREMA BEIGE

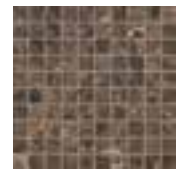

EMPERADOR



LINCOLN



CALACATTA GOLD

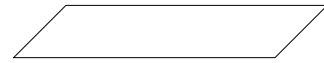

CHEVRON DX ◆ 10x59 (4"x24") RT 9 mm



CHEVRON SX ◆ 10x59 (4"x24") RT 9 mm



CALACATTA



SILVER GREY



PORT LAURENT



CREMA BEIGE



EMPERADOR



LINCOLN



CALACATTA GOLD

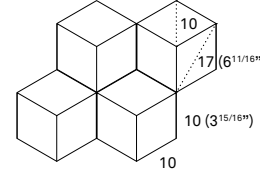

MOSAICO ROMBI
◆ 30,5x35,2 (12 1/16"x13 7/8") RT 9 mm



Port Laurent / Silver Grey / Lincoln

5

PEZZI SPECIALI/

TRIMS / PIECES SPECIALES / FORMTEILE /
PIEZAS ESPECIALES

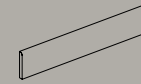

BATTISCOPA
BULLNOSE / PLINTHE / SOCKEL / RODAPIÉ
●◆ 7,2x60 (2.8"x24") RT 9 mm

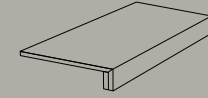

SCALINO INCOLLATO
GLUED STEP TREAD / NEZ DE MARCHE COLLÉ /
GEKLEBTE STUFENPLATTE / PELDAÑO CON PERFIL PEGADO
●◆ 33x60 (13"x24") RT 9 mm



ANGOLARE INCOLLATO
GLUED CORNER STEP TREAD / CARREAU DE MARCHE COLLÉ
PIÈCE ANGULAIRE / GEKLEBTE STUFENPLATTE ECKSTÜCK /
PELDAÑO ESQUINA CON PERFIL PEGADO
●◆ 33x33 (13"x13") RT 9 mm

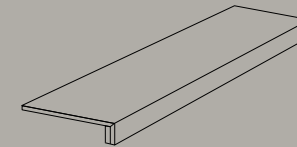

SCALINO INCOLLATO
GLUED STEP TREAD / NEZ DE MARCHE COLLÉ /
GEKLEBTE STUFENPLATTE / PELDAÑO CON PERFIL PEGADO
●◆ 33x120 (13"x48") RT 9 mm

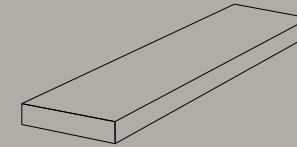

ANGOLARE INCOLLATO
GLUED CORNER STEP TREAD / CARREAU DE MARCHE COLLÉ
PIÈCE ANGULAIRE / GEKLEBTE STUFENPLATTE ECKSTÜCK /
PELDAÑO ESQUINA CON PERFIL PEGADO
●◆ 33x120 (13"x48") RT 9 mm

FORMATI

SIZES / FORMATS / FORMATE / FORMATOS

	120x278 (119,5x278)* 48"x110"	120x240 (119,5x239)* 48"x96"	120x120 (119,5x119,5)* 48"x48"	60x120 24"x48"	20x120 8"x48"	60x60 24"x24"	30x60 12"x24"
working size	1194x2778	1194x2390	1194x1194	596x1195	197x1195	596x596	297x596
	RT	RT	RT	RT	RT	RT	RT
	6 mm	9 mm	9 mm	9 mm	9 mm	9 mm	9 mm
E. LUX CALACATTA	◆	◆	◆	●◆	◆	●◆	●◆
E. LUX SILVER GREY	◆	◆	◆	●◆	◆	●◆	●◆
E. LUX CALACATTA GOLD	◆	◆	◆	●◆	◆	●◆	●◆
E. LUX EMPERADOR	◆			●◆	◆	●◆	●◆
E. LUX LINCOLN		◆	◆	●◆	◆	●◆	●◆
E. LUX PORT LAURENT	◆			●◆	◆	●◆	●◆
E. LUX CREMA BEIGE				●◆	◆	●◆	●◆

*Formato nominale / Nominal size / Format nominal / Nennformat / Formato nominal

● Natural R9 | ◆ Lappato



stone

EFFECT

074 / **Brystone**

086 / **Aran**

098 / **Midlake**

106 / **Chorus**

118 / **Suite**

126 / **Percorsi Extra**

138 / **Percorsi Quartz**

146 / **Percorsi Smart**

156 / **Alpi**

164 / **Back**

172 / **Code**

182 / **Langhe**

186 / **Pietre di Keope**

190 / **Point**

196 / **Sight**

200 / **Sunrise**

brystone

5

COLORI/
COLOURS
COULEURS
FARBE
COLORES

8

FORMATI/
SIZES
FORMATS
FORMATE
FORMATOS

3

SUPERFICI/
FINISHES
FINITIONS
OBERFLÄCHEN
ACABADOS

3

SPESSORI/
THICKNESS
ÉPAISSEUR
STÄRKE
ESPESOR





BRYSTONE AVANA
60x120 (24"x48")

BRYSTONE GOLD
120x278 (48"x110") - 60x120 (24"x48")



BRYSTONE IVORY
120x120 (48"x48")

stone effect | brystone



BRYSTONE GREY
120x120 (48"x48")



stone effect | brystone

5

COLORI/

COLOURS / COULEURS / FARBE / COLORES

BRYSTONE WHITE V2



BRYSTONE IVORY V2



BRYSTONE GOLD V2



BRYSTONE GREY V2



BRYSTONE AVANA V2



8

FORMATI/

SIZES / FORMATS / FORMATE / FORMATOS

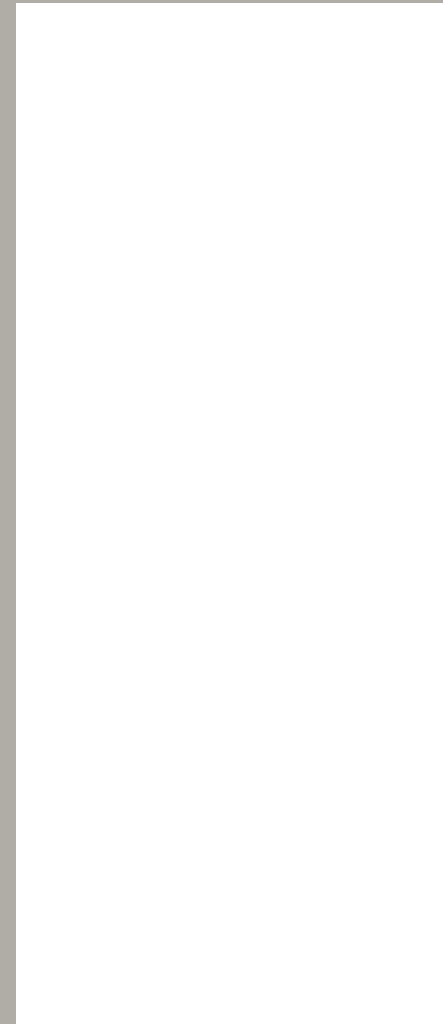

● 120x278 (48"x110") RT 6 mm

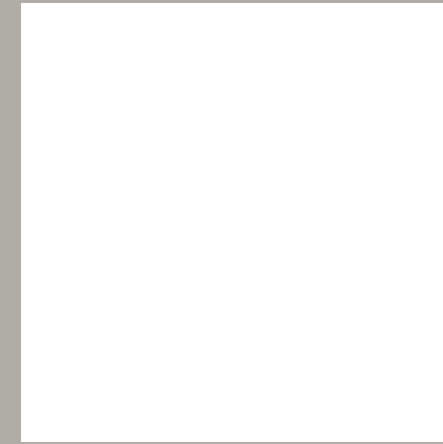

● 120x120 (48"x48") RT 9 mm

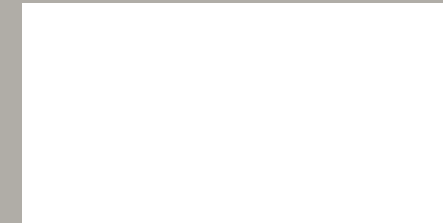

●■ 60x120 (24"x48") RT 9 mm



● 30x120 (12"x48") RT 9 mm



▲ 60x90 (24"x36") RT K2 20 mm

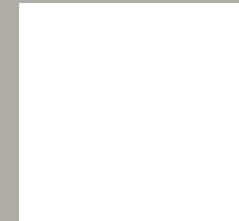

●■ 60x60 (24"x24") RT 9 mm



●■ 30x60 (12"x24") RT 9 mm



● 9,7x60 (3^{7/8}"x24") RT 9 mm

● Natural R9 | ■ Structured R10 | ▲ Structured R11

stone effect | brystone

2

DECORI/

DECORS / PIECES SPECIALES / FORMTEILE /
PIEZAS ESPECIALES

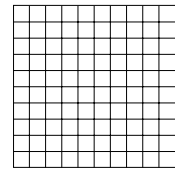

MOSAICO ● 30x30 (12"x12") RT 9 mm
(TESSERE: 2,8x2,8 - 1¹/₈"x1¹/₈")



BRYSTONE WHITE



BRYSTONE IVORY



BRYSTONE GOLD

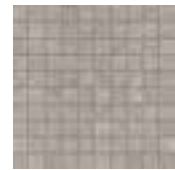

BRYSTONE GREY



BRYSTONE AVANA

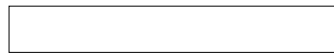

LISTELLO UP ● 9,7x60 (3⁷/₈"x24") RT 9 mm



BRYSTONE WHITE



BRYSTONE IVORY



BRYSTONE GOLD



BRYSTONE GREY

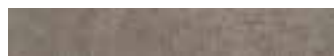

BRYSTONE AVANA

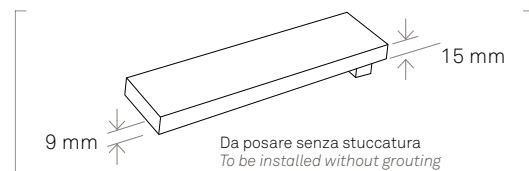

6

PEZZI SPECIALI/

TRIMS / PIECES SPECIALES / FORMTEILE /
PIEZAS ESPECIALES

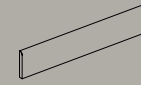

BATTISCOPA
BULLNOSE / PLINTHE / SOCKEL / RODAPIÉ
● 4,6x120 (1¹³/₁₆"x48") RT 9 mm
● 7,2x60 (2,8"x24") RT 9 mm

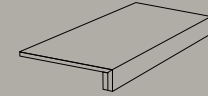

SCALINO CON PROFILO INCOLLATO
GLUED STEP TREAD / NEZ DE MARCHE COLLÉ /
GEKLEBTE STUFENPLATTE / PELDAÑO CON PERFIL PEGADO
● 33x60 (13"x24") RT 9 mm



SCALINO ANGOLARE CON PROFILO INCOLLATO
GLUED CORNER STEP TREAD / CARREAU DE MARCHE COLLÉ PIÈCE
ANGULAIRE / GEKLEBTE STUFENPLATTE ECKSTÜCK / PELDAÑO
ESQUINA CON PERFIL PEGADO
● 33x33 (13"x13") RT 9 mm

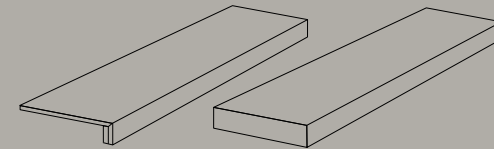

SCALINO INCOLLATO
GLUED STEP TREAD / NEZ DE MARCHE COLLÉ /
GEKLEBTE STUFENPLATTE / PELDAÑO CON PERFIL PEGADO
● 33x120 (13"x48") RT 9 mm

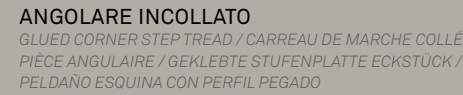

ANGOLARE INCOLLATO
GLUED CORNER STEP TREAD / CARREAU DE MARCHE COLLÉ
PIÈCE ANGULAIRE / GEKLEBTE STUFENPLATTE ECKSTÜCK /
PELDAÑO ESQUINA CON PERFIL PEGADO
● 33x120 (13"x48") RT 9 mm

14

PEZZI SPECIALI K₂/

TRIMS K₂ / PIECES SPECIALES K₂ / FORMTEILE K₂ /
PIEZAS ESPECIALES K₂

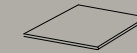

ANGOLARE BORDO CON TORO
CORNER STEP TREAD / NEZ DE MARCHE ANGULAIRE /
STUFENPLATTE ECKSTÜCK / ANGULAR CANTO ROMO
▲ 30x30 (12"x12") RT 20 mm

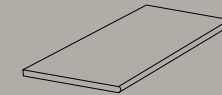

GRADINO BORDO CON TORO
ROUNDED STEP TREAD / NEZ DE MARCHE ARRONDI /
GERUNDET STUFENPLATTE / PELDAÑO CANTO ROMO
▲ 45x90 (18"x36") RT 20 mm
▲ 30x60 (12"x24") RT 20 mm

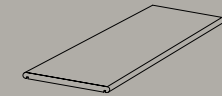

TOP BORDO TORO
TOP STEP TREAD / NEZ DE MARCHE HAUT /
STUFENPLATTE TOP / TOP CANTO ROMO
▲ 30x60 (12"x24") RT 20 mm

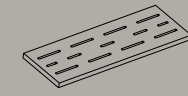

GRIGLIA
GRID / GRIL / GRILL / REJILLA
▲ 15x60 (6"x24") RT 20 mm

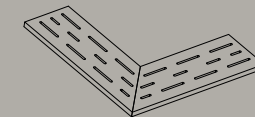

ANGOLARE GRIGLIA
GRID / GRIL / GRILL / ANGULAR REJILLA
▲ 15x60 (6"x24") RT 20 mm

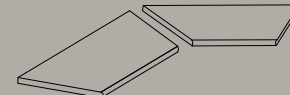

GRADINO ANGOLO INTERNO BORDO CON TORO
INT. CORNER STEP TREAD / ANGLE INT. NEZ DE MARCHE /
INNENECKTRITTSTUFE / ANG. INT. CANTO ROMO
▲ 45x90 (18"x36") RT 20 mm
▲ 30x60 (12"x24") RT 20 mm

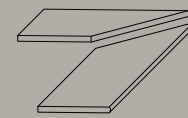

GRADINO ANGOLO ESTERNO BORDO CON TORO
EXT. CORNER STEP TREAD / ANGLE EXT. NEZ DE MARCHE /
AUSSENECKTRITTSTUFE / ANG. EXT. CANTO ROMO
▲ 45x90 (18"x36") RT 20 mm
▲ 30x60 (12"x24") RT 20 mm

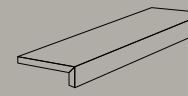

TERMINALE L
GLUED "L" TERMINAL / TERMINAL "L" COLLÉ /
"L" STÜCK FLIESE GEKLEBT / TERMINAL "L" (PEGADO)
▲ 90x45x15 (36"x18"x6") RT 20 mm
▲ 60x33x5 (24"x13"x2") RT 20 mm
▲ 60x20x5 (24"x8"x2") RT 20 mm

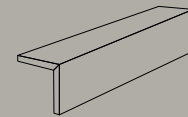

CORDOLO L
GLUED "L" TERMINAL / TERMINAL "L" COLLÉ /
"L" STÜCK FLIESE GEKLEBT / CANTONERA "L" (PEGADA)
▲ 60x20x15 (24"x8"x6") RT 20 mm

FORMATI

FORMATS / FORMATS / FORMATE / FORMATOS

	120x278 (119,5x278)* 48"x110"	120x120 (119,5x119,5)* 48"x48"	60x120 24"x48"	30x120 12"x48"	60x60 24"x24"	30x60 12"x24"	9,7x60 3 ⁷ / ₈ "x24"	60x90 24"x36"
working size	1194x2778	1194x1194	596x1195	297x1195	596x596	297x596	97x596	596x897
	RT	RT	RT	RT	RT	RT	RT	RT
	6 mm	9 mm	9 mm	9 mm	9 mm	9 mm	9 mm	K2 20 mm
BRYSTONE WHITE		●	●■	●	●■	●■	●	
BRYSTONE IVORY	●	●	●■	●	●■	●■	●	▲
BRYSTONE GOLD	●	●	●■	●	●■	●■	●	▲
BRYSTONE GREY		●	●■	●	●■	●■	●	▲
BRYSTONE AVANA		●	●■	●	●■	●■	●	

*Formato nominale / Nominal size / Format nominal / Nennformat / Formato nominal

● Natural R9 | ■ Structured R10 | ▲ Structured R11

aran

5

COLORI/
COLOURS
COULEURS
FARBE
COLORES

6

FORMATI/
SIZES
FORMATS
FORMATE
FORMATOS

2

SUPERFICI/
FINISHES
FINITIONS
OBERFLÄCHEN
ACABADOS

2

SPESSORI/
THICKNESS
ÉPAISSEUR
STÄRKE
ESPEJOR



Thanks to: Divano Extrasoft Living Divani | Composizione vasi Adriani&Rossi, Zanetto

ARAN IVORY
30x120 (12"x48") - 60x120 (24"x48")



stone effect | aran

Thanks to: Poltrona Betty Max Design



ARAN ANTHRACITE
30x120 (12"x48") - 60x120 (24"x48")



ARAN SILVER
60x120 (24"x48") - 30x120 (12"x48")
SCALINO INCOLLATO 33x120 (13"x48")



ARAN WALNUT
60x120 (24"x48")

Thanks to: Tavolo Araes Adele-C

5

COLORI/
COLOURS / COULEURS / FARBE / COLORES

ARAN IVORY V2



ARAN WALNUT V2



ARAN GREY V2



ARAN SILVER V2



ARAN ANTHRACITE V2

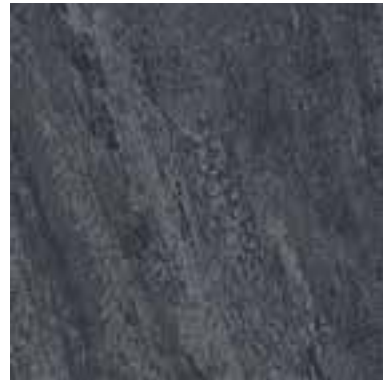

6

FORMATI/
SIZES / FORMATS / FORMATE / FORMATOS

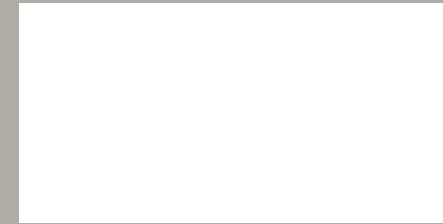

- 60x120 (24"x48") RT 9 mm
- ▲ 60x120 (24"x48") RT K2 20 mm



- 30x120 (12"x48") RT 9 mm

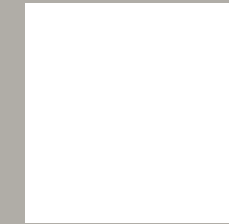

- 60x60 (24"x24") RT 9 mm



- ▲ 30x60 (12"x24") RT 9 mm



- 9,7x60 (37/8"x24") RT 9 mm

- Structured R10 | ▲ Structured R11

3

DECORI/

DECORS / PIECES SPECIALES / FORMTEILE /
PIEZAS ESPECIALES

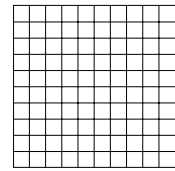

MOSAICO ■ 30x30 (12"x12") RT 9 mm
(TESSERE: 2,8x2,8 - 11/16"x11/16")

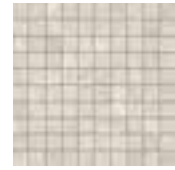

ARAN IVORY



ARAN WALNUT



ARAN GREY



ARAN SILVER



ARAN ANTHRACITE

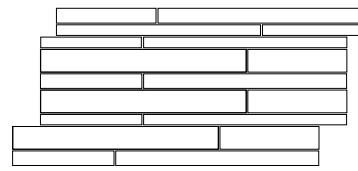

MOSAICO MULTISPESSORE ■ 30x60 (12"x24") RT 9 mm



ARAN IVORY



ARAN WALNUT



ARAN GREY



ARAN SILVER



ARAN ANTHRACITE



LISTELLO UP ■ 9,7x60 (37/8"x24") RT 9 mm



ARAN IVORY



ARAN WALNUT



ARAN GREY



ARAN SILVER



ARAN ANTHRACITE

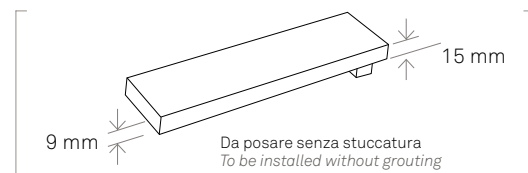

6

PEZZI SPECIALI/

TRIMS / PIECES SPECIALES / FORMTEILE /
PIEZAS ESPECIALES

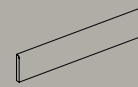

BATTISCOPA
BULLNOSE / PLINTHE / SOCKEL / RODAPIÉ
■ 4,6x120 (1 13/16"x48") RT 9 mm
■ 7,2x60 (2,8"x24") RT 9 mm

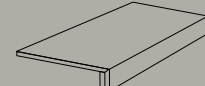

SCALINO CON PROFILO INCOLLATO
GLUED STEP TREAD / NEZ DE MARCHE COLLÉ /
GEKLEBTE STUFENPLATTE / PELDAÑO CON PERFIL PEGADO
■ 33x60 (13"x24") RT 9 mm

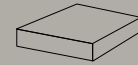

SCALINO ANGOLARE CON PROFILO INCOLLATO
GLUED CORNER STEP TREAD / CARREAU DE MARCHE COLLÉ PIÈCE
ANGULAIRE / GEKLEBTE STUFENPLATTE ECKSTÜCK / PELDAÑO
ESQUINA CON PERFIL PEGADO
■ 33x33 (13"x13") RT 9 mm

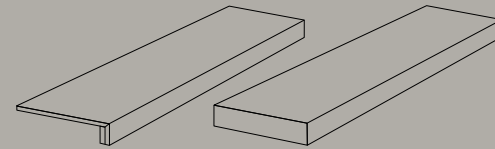

SCALINO INCOLLATO
GLUED STEP TREAD / NEZ DE MARCHE COLLÉ /
GEKLEBTE STUFENPLATTE / PELDAÑO CON PERFIL PEGADO
■ 33x120 (13"x48") RT 9 mm

ANGOLARE INCOLLATO
GLUED CORNER STEP TREAD / CARREAU DE MARCHE COLLÉ
PIÈCE ANGULAIRE / GEKLEBTE STUFENPLATTE ECKSTÜCK /
PELDAÑO ESQUINA CON PERFIL PEGADO
■ 33x120 (13"x48") RT 9 mm

FORMATI

FORMATS / FORMATS / FORMATE / FORMATOS

	60x120 24"x48"	30x120 12"x48"	60x60 24"x24"	30x60 12"x24"	9,7x60 37/8"x24"	60x120 24"x48"
working size	596x1195	297x1195	596x596	297x596	97x596	596x1195
	RT	RT	RT	RT	RT	RT
	9 mm	9 mm	9 mm	9 mm	9 mm	K2 20 mm
ARAN IVORY	■	■	■	■▲	■	
ARAN WALNUT	■	■	■	■▲	■	▲
ARAN GREY	■	■	■	■▲	■	
ARAN SILVER	■	■	■	■▲	■	▲
ARAN ANTHRACITE	■	■	■	■▲	■	▲

■ Structured R10 | ▲ Structured R11

9

PEZZI SPECIALI K2/

TRIMS K2 / PIECES SPECIALES K2 / FORMTEILE K2 /
PIEZAS ESPECIALES K2

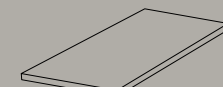

GRADINO BORDO CON TORO
ROUNDED STEP TREAD / NEZ DE MARCHE
ARRONDI / GERUNDET STUFENPLATTE /
PELDAÑO CANTO ROMO
▲ 60x120 (24"x48") RT 20 mm
▲ 30x120 (12"x48") RT 20 mm

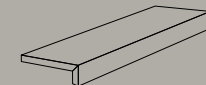

TERMINALE L
GLUED "L" TERMINAL / TERMINAL "L" COLLÉ /
"L" STÜCK FLIESE GEKLEBT / TERMINAL "L"
(PEGADO)
▲ 120x45x15 (48"x18" x6") RT 20 mm



GRADINO ANGOLO INTERNO BORDO CON TORO
INT. CORNER STEP TREAD / ANGLE INT. NEZ DE MARCHE /
INNENECKTRITTSTUFE / ANG. INT. CANTO ROMO
▲ 60x120 (24"x48") RT 20 mm
▲ 30x120 (12"x48") RT 20 mm

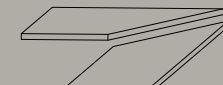

GRADINO ANGOLO ESTERNO BORDO CON TORO
EXT. CORNER STEP TREAD / ANGLE EXT. NEZ DE MARCHE /
AUSSENECKTRITTSTUFE / ANG. EXT. CANTO ROMO
▲ 60x120 (24"x48") RT 20 mm
▲ 30x120 (12"x48") RT 20 mm

midlake

4

COLORI/
COLOURS
COULEURS
FARBE
COLORES

5

FORMATI/
SIZES
FORMATS
FORMATE
FORMATOS

1

SUPERFICI/
FINISHES
FINITIONS
OBERFLÄCHEN
ACABADOS

2

SPESSORI/
THICKNESS
ÉPAISSEUR
STÄRKE
ESPEJOR



MIDLAKE PORFIDO
60x90 (24"x36") **K2** 20mm
ELEMENTO L 45x90x15 (18"x36"x6") **K2** 20mm
TOP BORDO TORO 45x90 (18"x36") **K2** 20mm
ANG. INT. BORDO TORO 45x90 (18"x36") **K2** 20mm
GRIGLIA 15x60 (6"x24") **K2** 20mm
ANG. GRIGLIA 15x60 (6"x24") **K2** 20mm





MIDLAKE QUARTZBEIGE
60x90 (24"x36") K2 20mm
GRADINO BORDO TORO
45x90 (18"x36") K2 20mm
ANG. INT. BORDO TORO
45x90 (18"x36") K2 20mm



MIDLAKE QUARTZBEIGE
60x90 (24"x36") K2 20mm

stone effect | midlake

4

COLORI/

COLOURS / COULEURS / FARBE / COLORES

QUARTZGREY V4



PORFIDO V4



ARDESIA V4



QUARTZBEIGE V3



5

FORMATI/

SIZES / FORMATS / FORMATE / FORMATOS

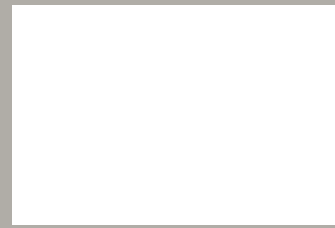

▲ 60x90 (24"x36") RT ➔ **K2** 20 mm



▲ 22,5x45,3 (9"x18") Not RT 9 mm
▲ 22,5x45,4 (9"x18") Not RT ➔ **K2** 20 mm



▲ 22,5x22,5 (9"x9") Not RT 9 mm
▲ 22,5x22,5 (9"x9") Not RT ➔ **K2** 20 mm

2

PEZZI SPECIALI/

TRIMS / PIECES SPECIALES / FORMTEILE / PIEZAS ESPECIALES



BATTISCOPA
BULLNOSE / PLINTHE / SOCKEL / RODAPIÉ
▲ 7,2x45,3 (2,8"x17¹³/₁₆") Not RT 9 mm



TERMINALE L MONOLITICO
L TERMINAL TEXTURED / TERMINALE ELLE STRUCTURÉ / STRUKTURIERTE L STÜCK FLIESE / REMATE EN FORMA DE L ESTRUCTURADO
▲ 30x15x4 (12"x6"x1⁹/₁₆") Not RT 9 mm

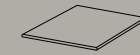

ANGOLARE BORDO CON TORO
CORNER STEP TREAD / NEZ DE MARCHE ANGULAIRE / STUFENPLATTE ECKSTÜCK / ANGULAR CANTO ROMO
▲ 30x30 (12"x12") RT 20 mm

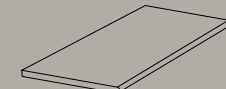

GRADINO BORDO CON TORO
ROUNDED STEP TREAD / NEZ DE MARCHE ARRONDI / GERUNDET STUFENPLATTE / PELDAÑO CANTO ROMO
▲ 45x90 (18"x36") RT 20 mm
▲ 30x60 (12"x24") RT 20 mm

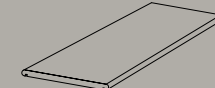

TOP BORDO TORO
TOP STEP TREAD / NEZ DE MARCHE HAUT / STUFENPLATTE TOP / TOP CANTO ROMO
▲ 30x60 (12"x24") RT 20 mm

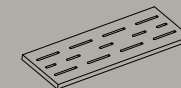

GRIGLIA
GRID / GRIL / GRILL / REJILLA
▲ 15x60 (6"x24") RT 20 mm

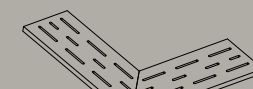

ANGOLARE GRIGLIA
GRID / GRIL / GRILL / ANGULAR REJILLA
▲ 15x60 (6"x24") RT 20 mm

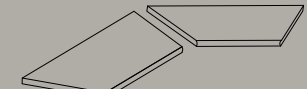

GRADINO ANGOLO INTERNO BORDO CON TORO
INT. CORNER STEP TREAD / ANGLE INT. NEZ DE MARCHE / INNENECKTRITTSTUFE / ANG. INT. CANTO ROMO
▲ 45x90 (18"x36") RT 20 mm
▲ 30x60 (12"x24") RT 20 mm

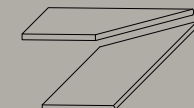

GRADINO ANGOLO ESTERNO BORDO CON TORO
EXT. CORNER STEP TREAD / ANGLE EXT. NEZ DE MARCHE / AUSSENECKTRITTSTUFE / ANG. EXT. CANTO ROMO
▲ 45x90 (18"x36") RT 20 mm
▲ 30x60 (12"x24") RT 20 mm

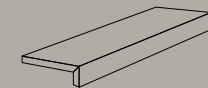

TERMINALE L
GLUED "L" TERMINAL / TERMINAL "L" COLLÉ / "L" STÜCK FLIESE GEKLEBT / TERMINAL "L" (PEGADO)
▲ 90x45x15 (36"x18"x6") RT 20 mm
▲ 60x33x5 (24"x13"x2") RT 20 mm
▲ 60x20x5 (24"x8"x2") RT 20 mm

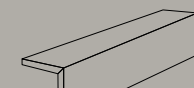

CORDOLO L
GLUED "L" TERMINAL / TERMINAL "L" COLLÉ / "L" STÜCK FLIESE GEKLEBT / CANTONERA "L" (PEGADA)
▲ 60x20x15 (24"x8"x6") RT 20 mm

FORMATI

FORMATS / FORMATS / FORMATE / FORMATOS

	22,5x45,3 9"x18"	22,5x22,5 9"x9"	60x90 24"x36"	22,5x45,4 9"x18"	22,5x22,5 9"x9"
working size	596x897				
	Not RT 9 mm	Not RT 9 mm	RT K2 20 mm	Not RT K2 20 mm	Not RT K2 20 mm
MIDLAKE QUARTZGREY	▲	▲	▲	▲	▲
MIDLAKE PORFIDO	▲	▲	▲	▲	▲
MIDLAKE QUARTZBEIGE	▲	▲	▲	▲	▲
MIDLAKE ARDESIA	▲	▲	▲	▲	▲

▲ Structured R11

▲ Structured R11

stone effect | midlake

chorus

5

COLORI/
COLOURS
COULEURS
FARBE
COLORES

11

FORMATI/
SIZES
FORMATS
FORMATE
FORMATOS

3

SUPERFICI/
FINISHES
FINITIONS
OBERFLÄCHEN
ACABADOS

2

SPESSORI/
THICKNESS
ÉPAISSEUR
STÄRKE
ESPESOR

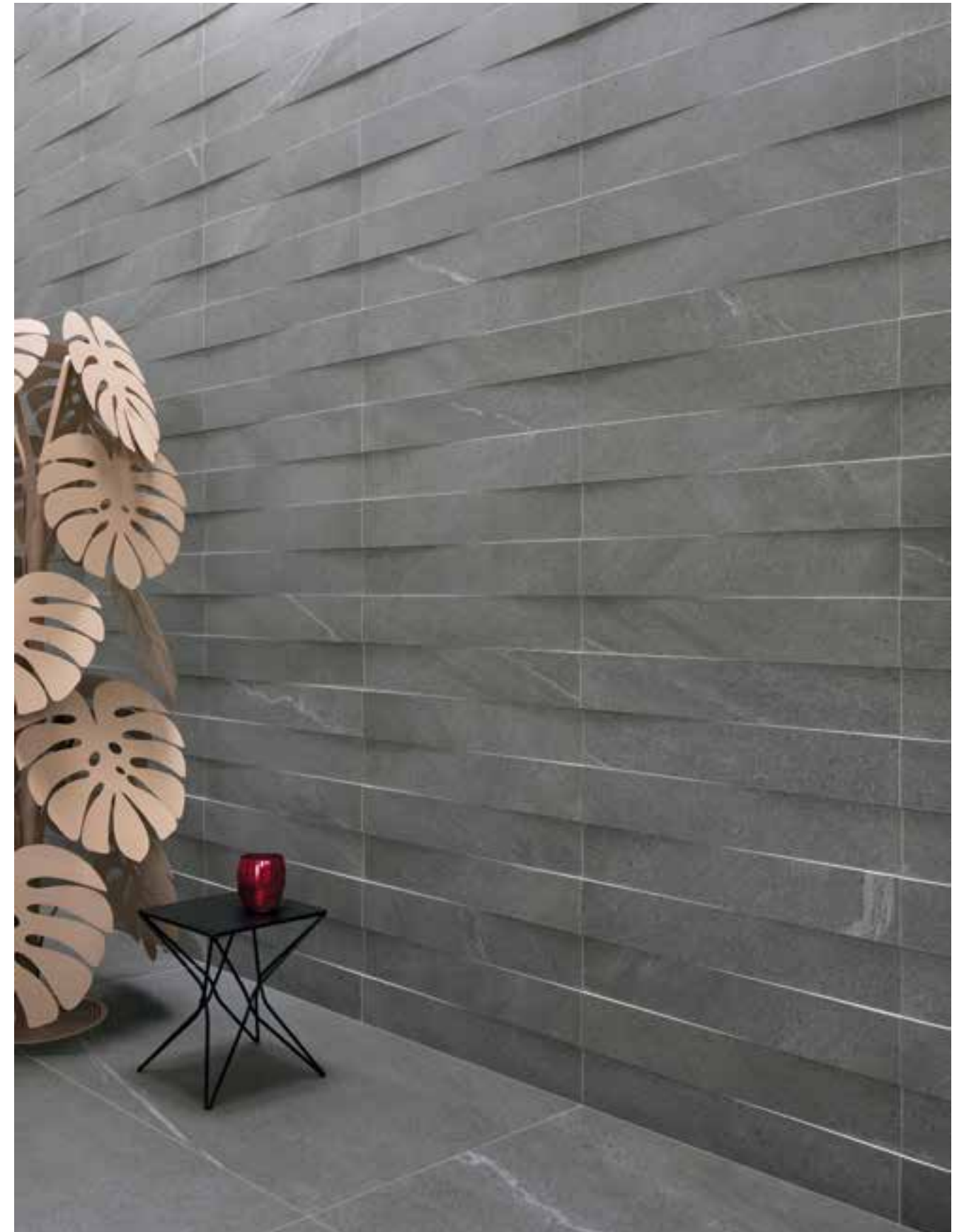

CHORUS TOBACCO
30x120 (12"x48")

CHORUS WHITE
120x120 (48"x48")



stone effect | chorus



CHORUS SILVER
60x120 (24"x48") - 30x120 (12"x48")



CHORUS BEIGE
120x120 (48"x48")

stone effect | chorus



CHORUS WHITE
75x75 (30"x30")

5

COLORI/

COLOURS / COULEURS / FARBE / COLORES

CHORUS TOBACCO V2



SILVER V2



GREY V2



WHITE V2



BEIGE V2



11

FORMATI/

SIZES / FORMATS / FORMATE / FORMATOS

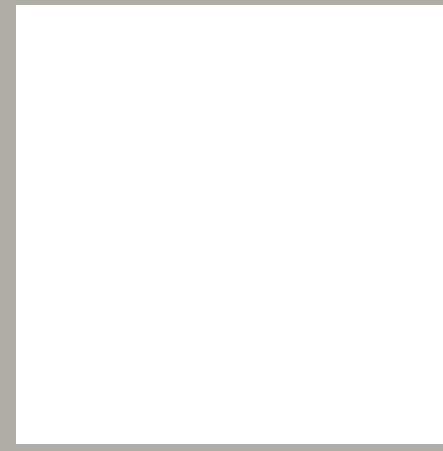

● 120x120 (48"x48") RT 9 mm

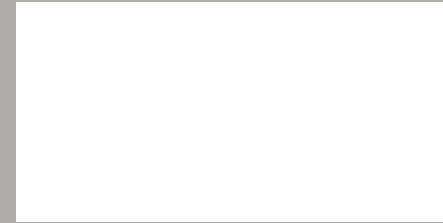

● ● ▲ 60x120 (24"x48") RT 9 mm
▲ 60x120 (24"x48") RT ≡ K2 20 mm



● 30x120 (12"x48") RT 9 mm

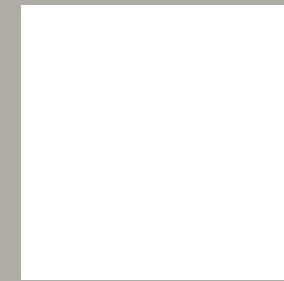

● 75x75 (30"x30") RT 9 mm

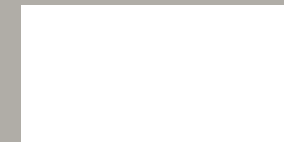

● 37,5x75 (15"x30") RT 9 mm

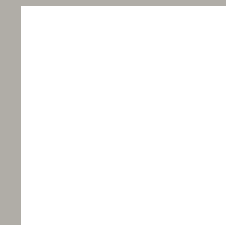

● ● ▲ 60x60 (24"x24") RT 9 mm
▲ 60x60 (24"x24") RT ≡ K2 20 mm



● ● ▲ 30x60 (12"x24") RT 9 mm
▲ 30x60 (12"x24") RT ≡ K2 20 mm



● 9,7x60 (3 7/8"x24") RT 9 mm

● Natural R9 | ● Natural R10 | ▲ Grip R11

stone effect | chorus

2

DECORI/

DECORS / PIECES SPECIALES / FORMTEILE /
PIEZAS ESPECIALES

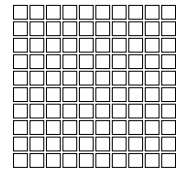

MOSAICO ● 30x30 (12"x12") RT 9mm
(TESSERE: 2,8x2,8 - 1^{1/8}"x1^{1/8}")



CHORUS TOBACCO

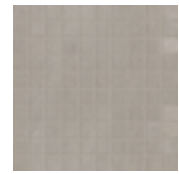

CHORUS SILVER



CHORUS GREY



CHORUS WHITE



CHORUS BEIGE



LISTELLO UP ● 9,7x60 (3^{7/8}"x24") RT 9 mm



CHORUS TOBACCO



CHORUS SILVER



CHORUS GREY



CHORUS WHITE



CHORUS BEIGE

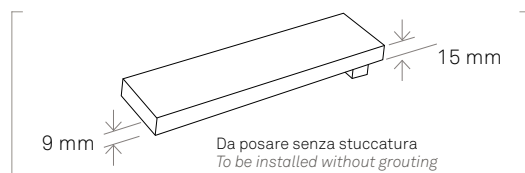

6

PEZZI SPECIALI/

TRIMS / PIECES SPECIALES / FORMTEILE /
PIEZAS ESPECIALES



BATTISCOPA
BULLNOSE / PLINTHE / SOCKEL / RODAPIÉ
● 7,2x75 (2.8"x30") RT 9 mm
● 7,2x60 (2.8"x24") RT 9 mm

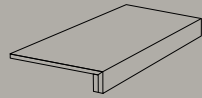

SCALINO CON PROFILO INCOLLATO
GLUED STEP TREAD / NEZ DE MARCHE COLLÉ /
GEKLEBTE STUFENPLATTE / PELDAÑO CON PERFIL PEGADO
● 33x60 (13"x24") RT 9 mm

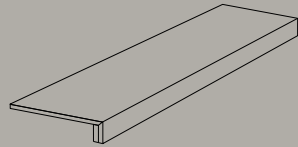

SCALINO CON PROFILO INCOLLATO
GLUED STEP TREAD / NEZ DE MARCHE COLLÉ /
GEKLEBTE STUFENPLATTE / PELDAÑO CON PERFIL PEGADO
● 33x120 (13"x48") RT 9 mm

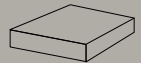

SCALINO ANGOLARE CON PROFILO INCOLLATO
GLUED CORNER STEP TREAD / CARREAU DE MARCHE COLLÉ
PIÈCE ANGULAIRE / GEKLEBTE STUFENPLATTE ECKSTÜCK /
PELDAÑO ESQUINA CON PERFIL PEGADO
● 33x33 (13"x13") RT 9 mm

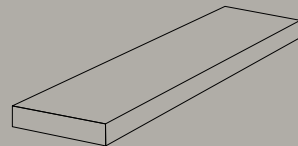

SCALINO ANGOLARE CON PROFILO INCOLLATO
GLUED CORNER STEP TREAD / CARREAU DE MARCHE COLLÉ
PIÈCE ANGULAIRE / GEKLEBTE STUFENPLATTE ECKSTÜCK /
PELDAÑO ESQUINA CON PERFIL PEGADO
● 33x120 (13"x48") RT 9 mm

17

PEZZI SPECIALI K₂/

TRIMS K₂ / PIECES SPECIALES K₂ / FORMTEILE K₂ /
PIEZAS ESPECIALES K₂

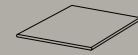

ANGOLARE BORDO CON TORO
CORNER STEP TREAD / NEZ DE MARCHE ANGULAIRE /
STUFENPLATTE ECKSTÜCK / ANGULAR CANTO ROMO
▲ 30x30 (12"x12") RT 20 mm

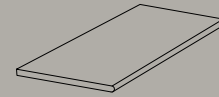

GRADINO BORDO CON TORO
ROUNDED STEP TREAD / NEZ DE MARCHE ARRONDI /
GERUNDET STUFENPLATTE / PELDAÑO CANTO ROMO
▲ 60x120 (24"x48") RT 20 mm
▲ 30x120 (12"x48") RT 20 mm
▲ 30x60 (12"x24") RT 20 mm

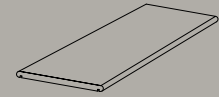

TOP
TOP STEP TREAD / NEZ DE MARCHE HAUT /
STUFENPLATTE TOP / TOP CANTO ROMO
▲ 30x60 (12"x24") RT 20 mm

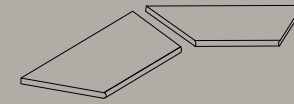

GRADINO ANGOLO INTERNO BORDO CON TORO
INT. CORNER STEP TREAD / ANGLE INT. NEZ DE MARCHE /
INNENECKTRITTSTUFE / ANG. INT. CANTO ROMO
▲ 60x120 (24"x48") RT 20 mm
▲ 30x120 (12"x48") RT 20 mm
▲ 30x60 (12"x24") RT 20 mm

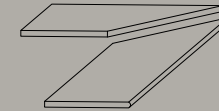

GRADINO ANGOLO ESTERNO BORDO CON TORO
EXT. CORNER STEP TREAD / ANGLE EXT. NEZ DE MARCHE /
AUSSENECKTRITTSTUFE / ANG. EXT. CANTO ROMO
▲ 60x120 (24"x48") RT 20 mm
▲ 30x120 (12"x48") RT 20 mm
▲ 30x60 (12"x24") RT 20 mm

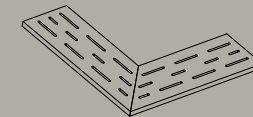

ANGOLARE GRIGLIA
GRID / GRIL / GRILL / ANGULAR REJILLA
▲ 15x60 (6"x24") RT 20 mm

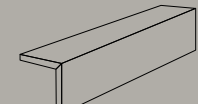

CORDOLO L
GLUED "L" TERMINAL / TERMINAL "L" COLLÉ /
"L" STÜCK FLIESE GEKLEBT / TERMINAL "L" (PEGADO)
▲ 60x20x15 (24"x8"x6") RT 20 mm

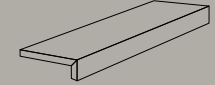

TERMINALE L
GLUED "L" TERMINAL / TERMINAL "L" COLLÉ /
"L" STÜCK FLIESE GEKLEBT / TERMINAL "L" (PEGADO)
▲ 120x45x15 (48"x18"x6") RT 20 mm
▲ 60x20x5 (24"x8"x2") RT 20 mm
▲ 33x60x5 (13"x24"x2") RT 20 mm

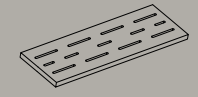

GRIGLIA
GRID / GRIL / GRILL / REJILLA
▲ 15x60 (6"x24") RT 20 mm

FORMATI

SIZES / FORMATS / FORMATE / FORMATOS

	120x120 (119,5x119,5)* 48"x48"	60x120 24"x48"	30x120 12"x48"	75x75 30"x30"	37,5x75 15"x30"	60x60 24"x24"	30x60 12"x24"	9,7x60 3 ^{7/8} "x24"	60x120 24"x48"	60x60 24"x24"	30x60 12"x24"
working size	1194x1194	596x1195	397x1195	748x748	373x748	596x596	297x596	97x596	596x1195	596x596	297x596
	RT	RT	RT	RT	RT	RT	RT	RT	RT	RT	RT
	9 mm	9 mm	9 mm	9 mm	9 mm	9 mm	9 mm	9 mm	K2 20 mm	K2 20 mm	K2 20 mm
CHORUS TOBACCO		●■▲	●	●	●	●■▲	●■▲	●			
CHORUS SILVER	●	●■▲	●	●	●	●■▲	●■▲	●	▲	▲	▲
CHORUS BEIGE	●	●■▲	●	●	●	●■▲	●■▲	●	▲	▲	▲
CHORUS GREY		●■▲	●	●	●	●■▲	●■▲	●			
CHORUS WHITE	●	●■▲	●	●	●	●■▲	●■▲	●	▲	▲	▲

*Formato nominale / Nominal size / Format nominal / Nennformat / Formato nominal

● Natural R9 | ■ Natural R10 | ▲ Grip R11

suite

5

COLORI/
COLOURS
COULEURS
FARBE
COLORES

7

FORMATI/
SIZES
FORMATS
FORMATE
FORMATOS

3

SUPERFICI/
FINISHES
FINITIONS
OBERFLÄCHEN
ACABADOS

1

SPESSORI/
THICKNESS
ÉPAISSEUR
STÄRKE
ESPEJOR





SUITE BEIGE
60x120 (24"x48") - 9,7x60 (4"x24")



SUITE IVORY
60x120 (24"x48")

SUITE TAUPE
120x120 (48"x48")

stone effect | suite

5

COLORI/
COLOURS / COULEURS / FARBE / COLORES

SUITE IVORY **V2**



SUITE GREY **V2**



SUITE BEIGE **V2**



SUITE ANTHRACITE **V2**



LEED
COMPLIANT

SUITE TAUPE **V2**



7

FORMATI/
SIZES / FORMATS / FORMATE / FORMATOS



● 120x120 (48"x48") RT 9 mm

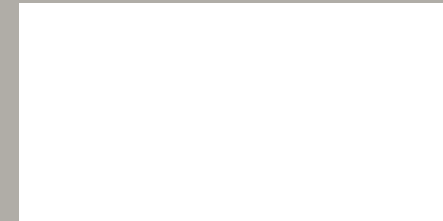

● 60x120 (24"x48") RT 9 mm



● 30x120 (12"x48") RT 9 mm

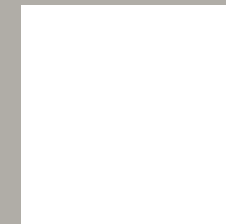

● 60x60 (24"x24") RT 9 mm



● ▲ 30x60 (12"x24") RT 9 mm



● 20x60 (8"x24") RT 9 mm



● 9,7x60 (3⁷/₈"x24") RT 9 mm

2 DECORI/ DECORS / PIECES SPECIALES / FORMTEILE / PIEZAS ESPECIALES

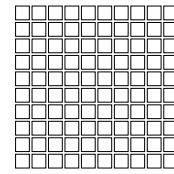

MOSAICO
● 30x30 (12"x12") RT 9 mm
(TESSERE: 2,8x2,8 - 1 1/8"x1 1/8")



LISTELLO UP
● 9,7x60 (3 7/8"x24") RT 9 mm

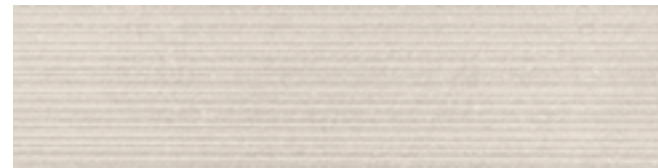

SUITE IVORY



SUITE IVORY



SUITE IVORY



SUITE GREY



SUITE GREY



SUITE GREY



SUITE BEIGE



SUITE BEIGE



SUITE BEIGE



SUITE ANTHRACITE



SUITE ANTHRACITE



SUITE ANTHRACITE



SUITE TAUPE



SUITE TAUPE



SUITE TAUPE

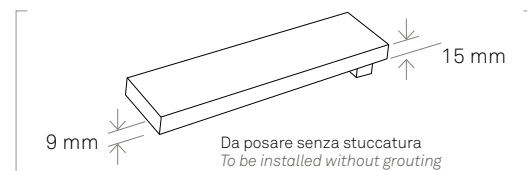

5 PEZZI SPECIALI/ TRIMS / PIECES SPECIALES / FORMTEILE / PIEZAS ESPECIALES

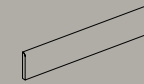

BATTISCOPA
BULLNOSE / PLINTHE / SOCKEL / RODAPIÉ
● 7,2x60 (2,8"x24") RT 9 mm

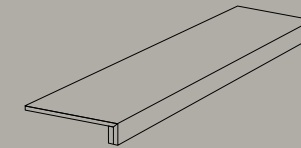

SCALINO INCOLLATO
GLUED STEP TREAD / NEZ DE MARCHE COLLÉ /
GEKLEBTE STUFENPLATTE / PELDAÑO CON PERFIL PEGADO
● 33x120 (13"x48") RT 9 mm

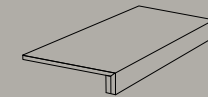

SCALINO CON PROFILO INCOLLATO
GLUED STEP TREAD / NEZ DE MARCHE COLLÉ /
GEKLEBTE STUFENPLATTE / PELDAÑO CON PERFIL PEGADO
● 33x60 (13"x24") RT 9 mm

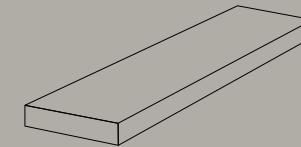

ANGOLARE INCOLLATO
GLUED CORNER STEP TREAD / CARREAU DE MARCHE COLLÉ
PIÈCE ANGULAIRE / GEKLEBTE STUFENPLATTE ECKSTÜCK /
PELDAÑO ESQUINA CON PERFIL PEGADO
● 33x120 (13"x48") RT 9 mm



SCALINO ANGOLARE CON PROFILO INCOLLATO
GLUED CORNER STEP TREAD / CARREAU DE MARCHE COLLÉ
PIÈCE ANGULAIRE / GEKLEBTE STUFENPLATTE ECKSTÜCK /
PELDAÑO ESQUINA CON PERFIL PEGADO
● 33x33 (13"x13") RT 9 mm

FORMATI FORMATS / FORMATS / FORMATE / FORMATOS

	120x120 (119,5x119,5)* 48"x48"	60x120 24"x48"	30x120 12"x48"	60x60 24"x24"	30x60 12"x24"	20x60 8"x24"	9,7x60 3 7/8"x24"
working size	1194x1194	596x1195	297x1195	596x596	297x596	197x596	97x596
	RT	RT	RT	RT	RT	RT	RT
	9 mm	9 mm	9 mm	9 mm	9 mm	9 mm	9 mm
SUITE IVORY	●	●	●■	●	●▲	●	●
SUITE BEIGE	●	●	●■	●	●▲	●	●
SUITE TAUPE	●	●	●■	●	●▲	●	●
SUITE GREY	●	●	●■	●	●▲	●	●
SUITE ANTHRACITE	●	●	●■	●	●▲	●	●

*Formato nominale / Nominal size / Format nominal / Nennformat / Formato nominal

● Natural R9 | ▲ Structured R11 | ■ 3D

percorsi extra

4

COLORI/
COLOURS
COULEURS
FARBE
COLORES

14

FORMATI/
SIZES
FORMATS
FORMATE
FORMATOS

3

SUPERFICI/
FINISHES
FINITIONS
OBERFLÄCHEN
ACABADOS

3

SPESSORI/
THICKNESS
ÉPAISSEUR
STÄRKE
ESPEJOR





PIETRA DI BARGE
60x60 (24"x24")



PIETRA DI FAEDIS
60x60 (24"x24") - 40x60 (16"x24")
30x60 (12"x24") - 30x30 (12"x12")



PIETRA DI COMBE
60x60 (24"x24") - 40x60 (16"x24") - 30x60 (12"x24")

4

COLORI/
COLOURS / COULEURS / FARBE / COLORES

PIETRA DI VALS **V3**



PIETRA DI COMBE **V2**



LEED
COMPLIANT

PIETRA DI BARGE **V3**



PIETRA DI FAEDIS **V3**



LEED
COMPLIANT

14

FORMATI/
SIZES / FORMATS / FORMATE / FORMATOS



▲ 120x240 (48"x96") ➡ K2 20 mm



▲ 30x240 (12"x96") ➡ K2 20 mm



▲ 120x120 (48"x48") ➡ K2 20 mm

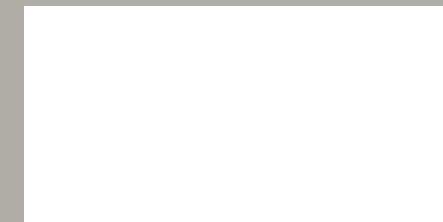

● ■ ▲ 60x120 (24"x48") RT 9 mm
▲ 60x120 (24"x48") ➡ K2 20 mm



▲ 30x120 (12"x48") ➡ K2 20 mm

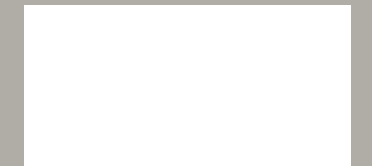

▲ 45x90 (18"x36") ➡ K2 20 mm

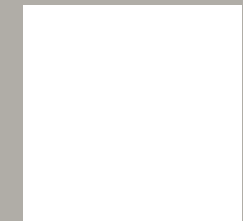

● ■ ▲ 60x60 (24"x24") RT 9 mm
▲ 60x60 (24"x24") ➡ K2 20 mm
▲ 60x60 (24"x24") ➡ K3 30 mm

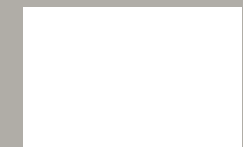

● ▲ 40x60 (16"x24") RT 9 mm



● ■ ▲ 30x60 (12"x24") RT 9 mm



● ▲ 20x60 (8"x24") RT 9 mm



● ▲ 30x30 (12"x12") RT 9 mm

● Natural R9 | ■ Structured R10 | ▲ Structured R11

3

DECORI/

DECORS / PIECES SPECIALES / FORMTEILE /
PIEZAS ESPECIALES

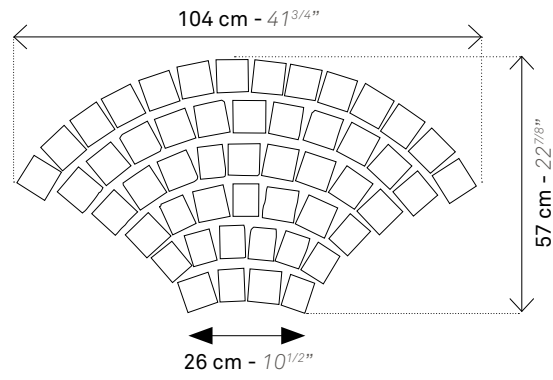

CODA DI PAVONE
▲ 104x57 (41^{3/4}"x22^{7/8}") RT 9 mm
(TOZZETTI: 6x7,5 - 21/2"x3" - 7,5x7,5 - 3"x3")



PIETRA DI VALS



PIETRA DI COMBE



PIETRA DI BARGE



PIETRA DI FAEDIS

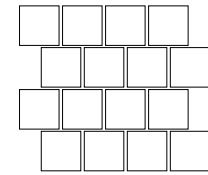

MOSAICO BURATTATO
▲ 31x31 (12^{1/2}"x12^{1/2}") RT 9 mm
(TOZZETTO: 7,5x7,5 - 3"x3")



PIETRA DI VALS



PIETRA DI COMBE



PIETRA DI BARGE



PIETRA DI FAEDIS

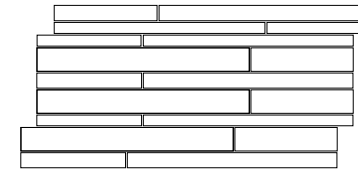

MOSAICO MULTISPESSORE
▲ 30x60 (12"x24") RT 9 mm

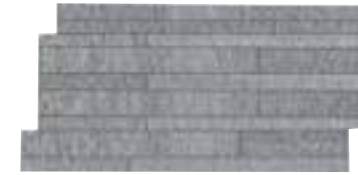

PIETRA DI VALS



PIETRA DI COMBE



PIETRA DI BARGE



PIETRA DI FAEDIS

Da posare senza stuccatura / To be installed
without grouting / À poser sans mastic / Ohne
Ausfugung zu verlegen / Colocación sin masilla

9

PEZZI SPECIALI/

TRIMS / PIECES SPECIALES / FORMTEILE /
PIEZAS ESPECIALES



BATTISCOPA
BULLNOSE / PLINTHE / SOCKEL / RODAPIÉ
●▲ 7,2x60 (2,8"x24") RT 9 mm

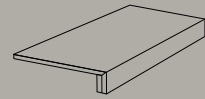

SCALINO CON PROFILO INCOLLATO
GLUED STEP TREAD / NEZ DE MARCHE COLLÉ /
GEKLEBTE STUFENPLATTE / PELDAÑO CON PERFIL PEGADO
●■▲ 33x60 (13"x24") RT 9 mm

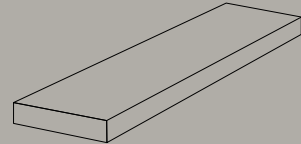

ANGOLARE INCOLLATO
GLUED CORNER STEP TREAD / CARREAU DE MARCHE COLLÉ
PIÈCE ANGULAIRE / GEKLEBTE STUFENPLATTE ECKSTÜCK /
PELDAÑO ESQUINA CON PERFIL PEGADO
●■▲ 33x120 (13"x48") RT 9 mm

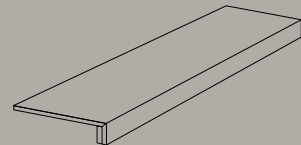

SCALINO INCOLLATO
GLUED STEP TREAD / NEZ DE MARCHE COLLÉ /
GEKLEBTE STUFENPLATTE / PELDAÑO CON PERFIL PEGADO
●■▲ 33x120 (13"x48") RT 9 mm



SCALINO ANGOLARE CON PROFILO INCOLLATO
GLUED CORNER STEP TREAD / CARREAU DE MARCHE COLLÉ PIÈCE ANGULAIRE /
GEKLEBTE STUFENPLATTE ECKSTÜCK / PELDAÑO ESQUINA CON PERFIL PEGADO
●■▲ 33x33 (13"x13") RT 9 mm



TERMINALE L INCOLLATO
GLUED L TERMINAL / TERMINALE ELLE COLLÉ / L STÜCK
FLIESE GEKLEBT / REMATE EN FORMA DE L PEGADO
●■▲ 30x4x15 (12"x1^{3/4}"x6") RT 9 mm

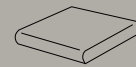

SCALINO ANGOLARE MONOLITICO
CORNER STEP TREAD TEXTURED / CARREAU DE MARCHE PIÈCE
ANGULAIRE STRUCTURÉ / STRUKTURIERTE STUFENPLATTE ECKSTÜCK /
PELDAÑO ESQUINA ESTRUCTURADO
▲ 33x33 (13"x13") RT 10 mm



SCALINO MONOLITICO
STEP TREAD TEXTURED / NEZ DE MARCHE STRUCTURÉ /
STRUKTURIERTE STUFENPLATTE / PELDAÑO ESTRUCTURADO
▲ 30x33 (12"x13") RT 10 mm

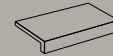

TERMINALE L MONOLITICO
L TERMINAL TEXTURED / TERMINALE ELLE STRUCTURÉ /
STRUKTURIERTE L STÜCK FLIESE / REMATE EN FORMA DE L ESTRUCTURADO
▲ 30x3,8x16,5 (12"x1^{1/2}"x6^{1/2}") Not RT 10 mm

21

PEZZI SPECIALI K₂/

TRIMS K₂ / PIECES SPECIALES K₂ / FORMTEILE K₂ /
PIEZAS ESPECIALES K₂

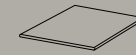

ANGOLARE BORDO CON TORO
CORNER STEP TREAD / NEZ DE MARCHE ANGULAIRE /
STUFENPLATTE ECKSTÜCK / ANGULAR CANTO ROMO
▲ 30x30 (12"x12") RT 20 mm

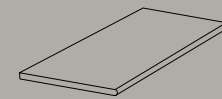

GRADINO BORDO CON TORO
ROUNDED STEP TREAD / NEZ DE MARCHE ARRONDI /
GERUNDET STUFENPLATTE / PELDAÑO CANTO ROMO
▲ 60x120 (24"x48") RT 20 mm
▲ 30x120 (12"x48") RT 20 mm
▲ 45x90 (18"x36") RT 20 mm
▲ 30x60 (12"x24") RT 20 mm

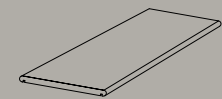

TOP BORDO TORO
TOP STEP TREAD / NEZ DE MARCHE HAUT /
STUFENPLATTE TOP / TOP CANTO ROMO
▲ 30x60 (12"x24") RT 20 mm

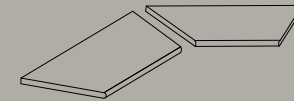

GRADINO ANGOLO INTERNO BORDO CON TORO
INT. CORNER STEP TREAD / ANGLE INT. NEZ DE MARCHE /
INNENECKTRITTSTUFE / ANG. INT. CANTO ROMO
▲ 60x120 (24"x48") RT 20 mm
▲ 30x120 (12"x48") RT 20 mm
▲ 45x90 (18"x36") RT 20 mm
▲ 30x60 (12"x24") RT 20 mm

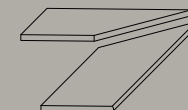

GRADINO ANGOLO ESTERNO BORDO CON TORO
EXT. CORNER STEP TREAD / ANGLE ÉXT. NEZ DE MARCHE /
AUSSENECKTRITTSTUFE / ANG. EXT. CANTO ROMO
▲ 60x120 (24"x48") RT 20 mm
▲ 30x120 (12"x48") RT 20 mm
▲ 45x90 (18"x36") RT 20 mm
▲ 30x60 (12"x24") RT 20 mm

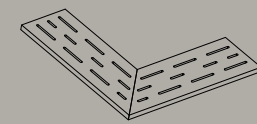

ANGOLARE GRIGLIA
GRID / GRIL / GRILL / ANGULAR REJILLA
▲ 15x60 (6"x24") RT 20 mm

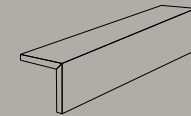

CORDOLO L
GLUED "L" TERMINAL / TERMINAL "L" COLLÉ /
"L" STÜCK FLIESE GEKLEBT / CANTONERA "L" (PEGADA)
▲ 60x20x15 (24"x8"x6") RT 20 mm

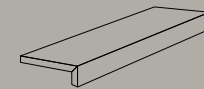

TERMINALE L
GLUED "L" TERMINAL / TERMINAL "L" COLLÉ /
"L" STÜCK FLIESE GEKLEBT / TERMINAL "L" (PEGADO)
▲ 120x45x15 (48"x18"x6") RT 20 mm
▲ 90x45x15 (36"x18"x6") RT 20 mm
▲ 60x20x5 (24"x8"x2") RT 20 mm
▲ 33x60x5 (13"x24"x2") RT 20 mm

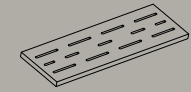

GRIGLIA
GRID / GRIL / GRILL / REJILLA
▲ 15x60 (6"x24") RT 20 mm

FORMATI

FORMATS / FORMATS / FORMATE / FORMATOS

	60x120 24"x48"	60x60 24"x24"	40x60 16"x24"	30x60 12"x24"	20x60 8"x24"	30x30 12"x12"	120x240 (119,5x239)* 48"x96"	30x240 (30x239)* 12"x96"	120x120 (119,5x119,5)* 48"x48"	60x120 24"x48"	30x120 12"x48"	45x90 18"x36"	60x60 24"x24"	60x60 24"x24"
working size	596x1195	596x596	396x596	297x596	197x596	297x297	1194x2390	297x2390	1194x1194	596x1195	297x1195	446x895	596x596	596x596
	RT	RT	RT	RT	RT	RT	RT	RT	RT	RT	RT	RT	RT	RT
	9 mm	9 mm	9 mm	9 mm	9 mm	9 mm	K2 20 mm	K2 20 mm	K2 20 mm	K2 20 mm	K2 20 mm	K2 20 mm	K2 20 mm	K3 30 mm
PIETRA DI VALS	●■▲	●■▲	●▲	●■▲	●▲	●▲	▲	▲	▲	▲	▲	▲	▲	▲
PIETRA DI BARGE	●■▲	●■▲	●▲	●■▲	●▲	●▲			▲	▲	▲	▲	▲	▲
PIETRA DI FAEDIS	●■▲	●■▲	●▲	●■▲	●▲	●▲						▲	▲	
PIETRA DI COMBE	●■▲	●■▲	●▲	●■▲	●▲	●▲						▲	▲	

*Formato nominale / Nominal size / Format nominal / Nennformat / Formato nominal

● Natural R9 | ■ Structured R10 | ▲ Structured R11

percorsi quartz

4

COLORI/
COLOURS
COULEURS
FARBE
COLORES

5

FORMATI/
SIZES
FORMATS
FORMATE
FORMATOS

2

SUPERFICI/
FINISHES
FINITIONS
OBERFLÄCHEN
ACABADOS

2

SPESSORI/
THICKNESS
ÉPAISSEUR
STÄRKE
ESPESOR





PERCORSI QUARTZ SAND
60x60 (24"x24") - 30x60 (12"x24")



PERCORSI QUARTZ BLACK
60x60 (24"x24") - 30x60 (12"x24")
40x60 (16"x24") - 20x60 (8"x24")

4

COLORI/

COLOURS / COULEURS / FARBE / COLORES

PERCORSI QUARTZ WHITE V2



PERCORSI QUARTZ SAND V2



PERCORSI QUARTZ BLACK V2

LEED COMPLIANT



PERCORSI QUARTZ GREY V2

LEED COMPLIANT



5

FORMATI/

SIZES / FORMATS / FORMATE / FORMATOS

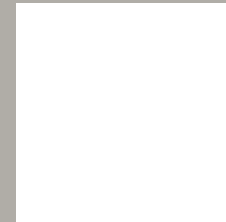

- ▲ 60x60 (24"x24") RT 9 mm
- ▲ 60x60 (24"x24") RT ➔ K2 20 mm

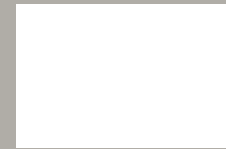

- ▲ 40x60 (16"x24") RT 9 mm

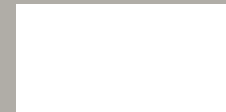

- ▲ 30x60 (12"x24") RT 9 mm



- ▲ 20x60 (8"x24") RT 9 mm

7

PEZZI SPECIALI/

TRIMS / PIECES SPECIALES / FORMTEILE / PIEZAS ESPECIALES

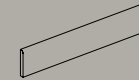

BATTISCOPIA

BULLNOSE / PLINTHE / SOCKEL / RODAPIÉ

- ▲ 7,2x60 (2,8"x24") RT 9 mm

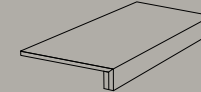

SCALINO CON PROFILO INCOLLATO

GLUED STEP TREAD / NEZ DE MARCHE COLLÉ / GEKLEBTE STUFENPLATTE / PELDAÑO CON PERFIL PEGADO

- ▲ 33x60 (13"x24") RT 9 mm

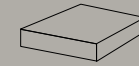

SCALINO ANGOLARE CON PROFILO INCOLLATO

GLUED CORNER STEP TREAD / CARREAU DE MARCHE COLLÉ / PIÈCE ANGULAIRE / GEKLEBTE STUFENPLATTE ECKSTÜCK / PELDAÑO ESQUINA CON PERFIL PEGADO

- ▲ 33x33 (13"x13") RT 9 mm



TERMINALE L INCOLLATO

GLUED L TERMINAL / TERMINALE ELLE COLLÉ / L STÜCK FLIESE GEKLEBT / REMATE EN FORMA DE L PEGADO

- ▲ 30x4x15 (12"x13/4"x6") RT 9 mm



SCALINO MONOLITICO

STEP TREAD TEXTURED / NEZ DE MARCHE STRUCTURÉ / STRUKTURIERTE STUFENPLATTE / PELDAÑO ESTRUCTURADO

- ▲ 30x33 (12"x13") RT 10 mm

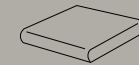

SCALINO ANGOLARE MONOLITICO

CORNER STEP TREAD TEXTURED / CARREAU DE MARCHE PIECE ANGULAIRE STRUCTURÉ / STRUKTURIERTE STUFENPLATTE ECKSTÜCK / PELDAÑO ESQUINA ESTRUCTURADO

- ▲ 33x33 (13"x13") RT 10 mm

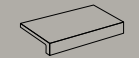

TERMINALE L MONOLITICO

L TERMINAL TEXTURED / TERMINALE ELLE STRUCTURÉ / STRUKTURIERTE L STÜCK FLIESE / REMATE EN FORMA DE L ESTRUCTURADO

- ▲ 30x3,8x16,5 (12"x1 1/2"x6 1/2") Not RT 10 mm

- Natural R9 | ▲ Structured R11

2

DECORI/

DECORS / PIECES SPECIALES / FORMTEILE /
PIEZAS ESPECIALES

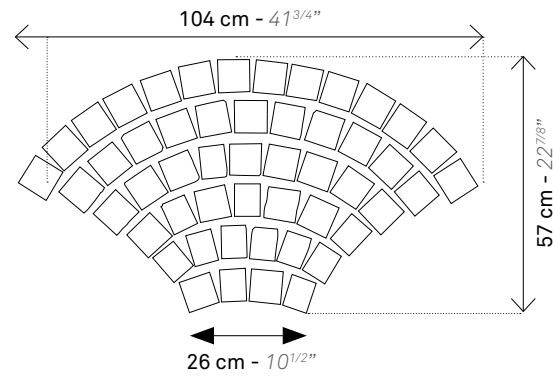

CODA DI PAVONE

▲ 104x57 (41 3/4"x22 7/8") RT 9 mm
(TOZZETTI: 6x7,5 - 21/2"x3" - 7,5x7,5 - 3"x3")



PERCORSI QUARTZ WHITE



PERCORSI QUARTZ SAND

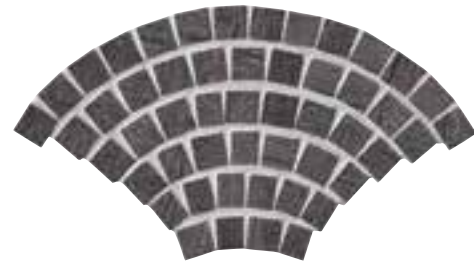

PERCORSI QUARTZ SAND



PERCORSI QUARTZ GREY

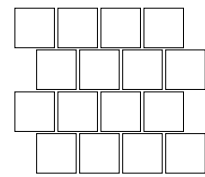

MOSAICO BURATTATO

▲ 31x31 (12 1/2"x12 1/2") RT 9 mm
(TOZZETTO: 7,5x7,5 - 3"x3")



PERCORSI QUARTZ WHITE



PERCORSI QUARTZ SAND



PERCORSI QUARTZ BLACK



PERCORSI QUARTZ GREY

10

PEZZI SPECIALI K2/

TRIMS K2 / PIECES SPECIALES K2 / FORMTEILE K2 /
PIEZAS ESPECIALES K2

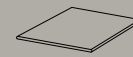

ANGOLARE BORDO CON TORO

CORNER STEP TREAD / NEZ DE MARCHE ANGULAIRE /
STUFENPLATTE ECKSTÜCK / ANGULAR CANTO ROMO
▲ 30x30 (12"x12") RT 20 mm

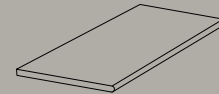

GRADINO BORDO CON TORO

ROUNDED STEP TREAD / NEZ DE MARCHE ARRONDI /
GERUNDET STUFENPLATTE / PELDAÑO CANTO ROMO
▲ 30x60 (12"x24") RT 20 mm

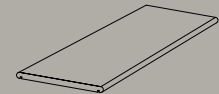

TOP BORDO TORO

TOP STEP TREAD / NEZ DE MARCHE HAUT /
STUFENPLATTE TOP / TOP CANTO ROMO
▲ 30x60 (12"x24") RT 20 mm

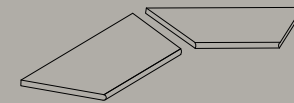

GRADINO ANGOLO INTERNO BORDO CON TORO

INT. CORNER STEP TREAD / ANGLE INT. NEZ DE MARCHE /
INNENECKTRITTSTUFE / ANG. INT. CANTO ROMO
▲ 30x60 (12"x24") RT 20 mm

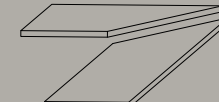

GRADINO ANGOLO ESTERNO BORDO CON TORO

EXT. CORNER STEP TREAD / ANGLE EXT. NEZ DE MARCHE /
AUSSENECKTRITTSTUFE / ANG. EXT. CANTO ROMO
▲ 30x60 (12"x24") RT 20 mm

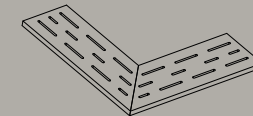

ANGOLARE GRIGLIA

GRID / GRIL / GRILL / ANGULAR REJILLA
▲ 15x60 (6"x24") RT 20 mm

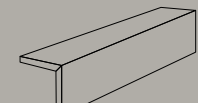

CORDOLO L

GLUED "L" TERMINAL / TERMINAL "L" COLLÉ /
"L" STÜCK FLIESE GEKLEBT / CANTONERA "L" (PEGADA)
▲ 60x20x15 (24"x8"x6") RT 20 mm

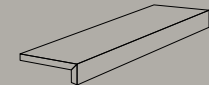

TERMINALE L

GLUED "L" TERMINAL / TERMINAL "L" COLLÉ /
"L" STÜCK FLIESE GEKLEBT / TERMINAL "L" (PEGADO)
▲ 60x33x5 (24"x13"x2") RT 20 mm
▲ 60x20x5 (24"x8"x2") RT 20 mm

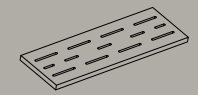

GRIGLIA

GRID / GRIL / GRILL / REJILLA
▲ 15x60 (6"x24") RT 20 mm

FORMATI

FORMATS / FORMATS / FORMATE / FORMATOS

	60x60 24"x24"	40x60 16"x24"	30x60 12"x24"	20x60 8"x24"	60x60 24"x24"
working size	596x596	396x596	297x596	197x596	596x596
	RT	RT	RT	RT	RT
	9 mm	9 mm	9 mm	9 mm	K2 20 mm
PERCORSI QUARTZ WHITE	●▲	●▲	●▲	●▲	▲
PERCORSI QUARTZ SAND	●▲	●▲	●▲	●▲	
PERCORSI QUARTZ BLACK	●▲	●▲	●▲	●▲	▲
PERCORSI QUARTZ GREY	●▲	●▲	●▲	●▲	

*Formato nominale / Nominal size / Format nominal / Nennformat / Formato nominal

● Natural R9 | ▲ Structured R11

percorsi smart

3

COLORI/
COLOURS
COULEURS
FARBE
COLORES

11

FORMATI/
SIZES
FORMATS
FORMATE
FORMATOS

2

SUPERFICI/
FINISHES
FINITIONS
OBERFLÄCHEN
ACABADOS

3

SPESSORI/
THICKNESS
ÉPAISSEUR
STÄRKE
ESPESOR

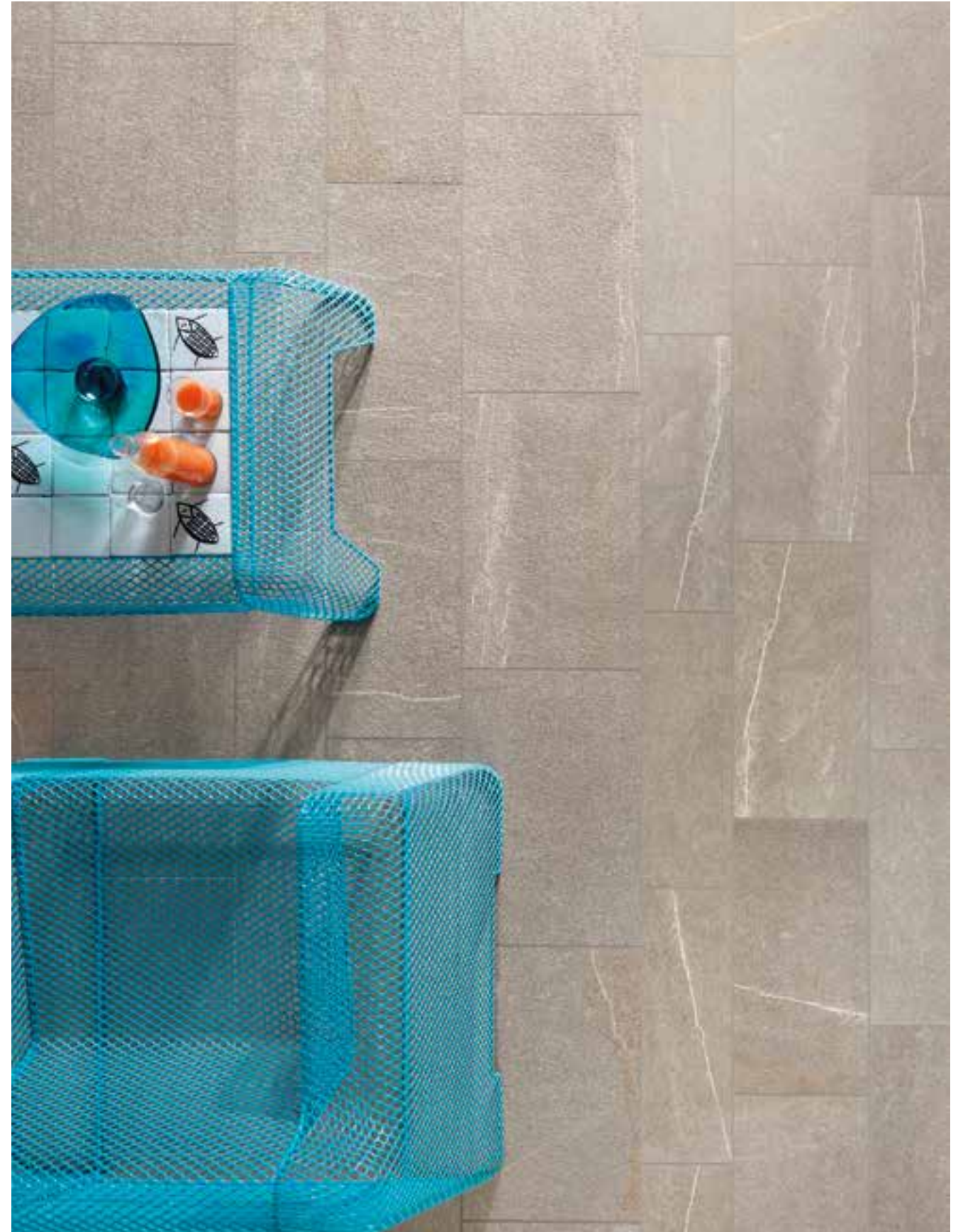



PIETRA DI BRESSA
40x60 (16"x24") - 30x60 (12"x24") - 20x60 (8"x24")



PIETRA DI BAGNOLO
120x120 (48"x48") K2 20mm

stone effect | percorsi smart

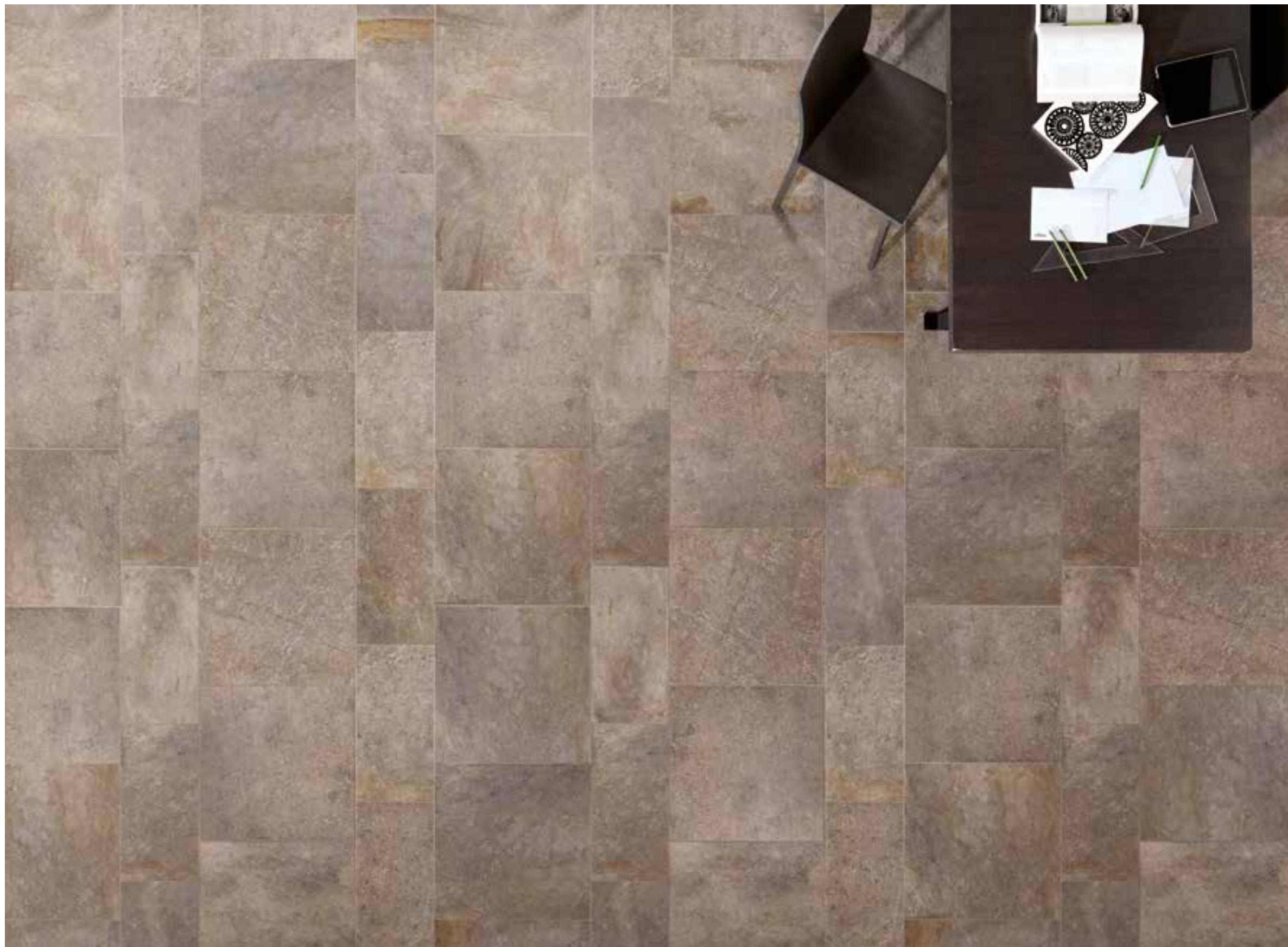

PIETRA DI LAVIS
60x60 (24"x24") - 30x60 (12"x24")

3

COLORI/

COLOURS / COULEURS / FARBE / COLORES

PIETRA DI BRESSA V3



PIETRA DI BAGNOLO V2



PIETRA DI LAVIS V4



11

FORMATI/

SIZES / FORMATS / FORMATE / FORMATOS

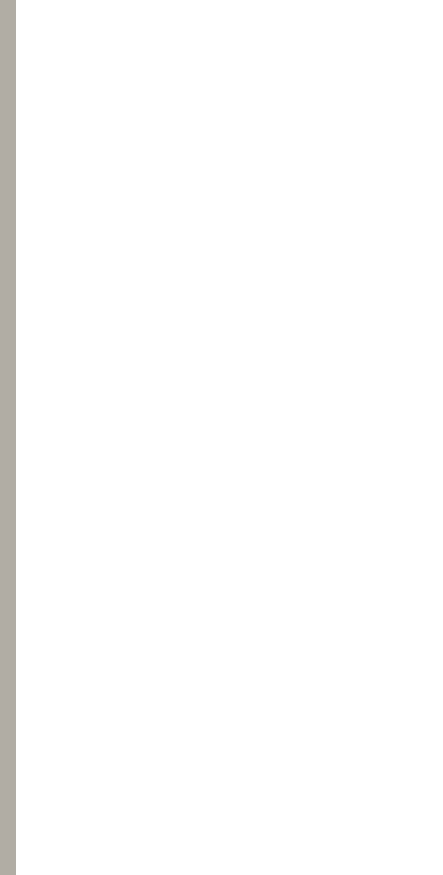

▲ 120x240 (48"x96") RT K2 20 mm



▲ 30x240 (12"x96") RT K2 20 mm

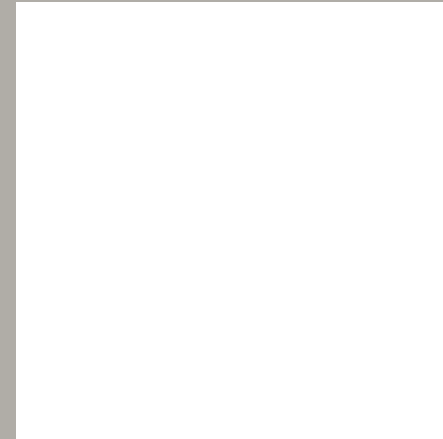

▲ 120x120 (48"x48") RT K2 20 mm



▲ 45x90 (18"x36") RT K2 20 mm

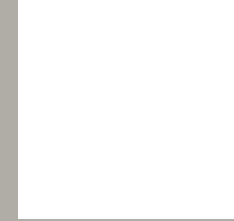

- ▲ 60x60 (24"x24") RT 9 mm
- ▲ 60x60 (24"x24") RT K2 20 mm
- ▲ 60x60 (24"x24") RT K3 30 mm

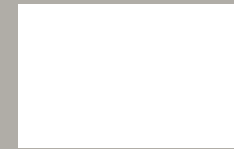

- ▲ 40x60 (16"x24") RT 9 mm



- ▲ 30x60 (12"x24") RT 9mm



- ▲ 20x60 (8"x24") RT 9 mm



- ▲ 15x30 (6"x12") Not RT 9 mm

● Natural R9 | ▲ Structured R11

1

DECORI/

DECORS / PIECES SPECIALES / FORMTEILE /
PIEZAS ESPECIALES

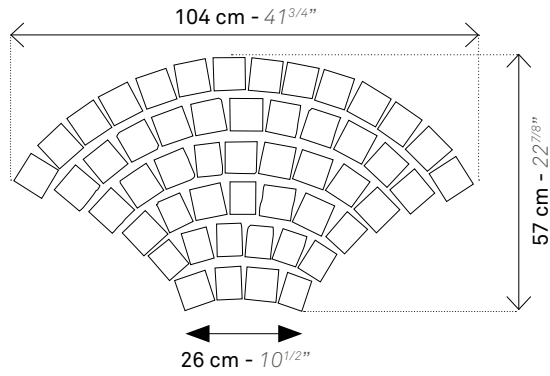

CODA DI PAVONE
▲ 104x57 (41^{3/4}”x22^{7/8}”) RT 9 mm
(TOZZETTI: 6x7,5 - 21/2”x3” - 7,5x7,5 - 3”x3”)



PIETRA DI BRESSA



PIETRA DI BAGNOLO



PIETRA DI LAVIS

5

PEZZI SPECIALI/

TRIMS / PIECES SPECIALES / FORMTEILE /
PIEZAS ESPECIALES



BATTISCOPIA
BULLNOSE / PLINTHE / SOCKEL / RODAPIÉ
●▲ 7,2x60 (2,8”x24”) RT 9 mm

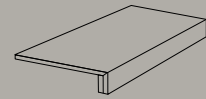

SCALINO CON PROFILO INCOLLATO
GLUED STEP TREAD / NEZ DE MARCHE COLLÉ /
GEKLEBTE STUFENPLATTE / PELDAÑO CON PERFIL PEGADO
●▲ 33x60 (13”x24”) RT 9 mm



SCALINO ANGOLARE CON PROFILO INCOLLATO
GLUED CORNER STEP TREAD / CARREAU DE MARCHE COLLÉ /
PIÈCE ANGULAIRE / GEKLEBTE STUFENPLATTE ECKSTÜCK /
PELDAÑO ESQUINA CON PERFIL PEGADO
●▲ 33x33 (13”x13”) RT 9 mm

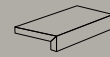

TERMINALE L INCOLLATO
GLUED L TERMINAL / TERMINALE ELLE COLLÉ / L STÜCK
FLIESE GEKLEBT / REMATE EN FORMA DE L PEGADO
●▲ 30x4x15 (12”x1^{3/4}”x6”) RT 9 mm

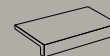

TERMINALE L MONOLITICO
L TERMINAL TEXTURED / TERMINALE ELLE STRUCTURÉ /
STRUKTURIERTE L STÜCK FLIESE / REMATE EN FORMA
DE L ESTRUCTURADO
▲ 30x3,8x16,5 (12”x1^{1/2}”x6^{1/2}”) Not RT 10mm

15

PEZZI SPECIALI K₂/

TRIMS K₂ / PIECES SPECIALES K₂ / FORMTEILE K₂ /
PIEZAS ESPECIALES K₂

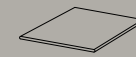

ANGOLARE BORDO CON TORO
CORNER STEP TREAD / NEZ DE MARCHE ANGULAIRE /
STUFENPLATTE ECKSTÜCK / ANGULAR CANTO ROMO
▲ 30x30 (12”x12”) RT 20 mm

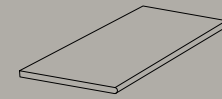

GRADINO BORDO CON TORO
ROUNDED STEP TREAD / NEZ DE MARCHE ARRONDI /
GERUNDET STUFENPLATTE / PELDAÑO CANTO ROMO
▲ 45x90 (18”x36”) RT 20 mm
▲ 30x60 (12”x24”) RT 20 mm

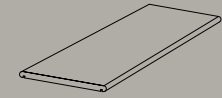

TOP BORDO TORO
TOP STEP TREAD / NEZ DE MARCHE HAUT /
STUFENPLATTE TOP / TOP CANTO ROMO
▲ 30x60 (12”x24”) RT 20 mm

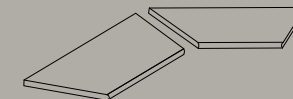

GRADINO ANGOLO INTERNO BORDO CON TORO
INT. CORNER STEP TREAD / ANGLE INT. NEZ DE MARCHE /
INNENECKTRITTSTUFE / ANG. INT. CANTO ROMO
▲ 45x90 (18”x36”) RT 20 mm
▲ 30x60 (12”x24”) RT 20 mm

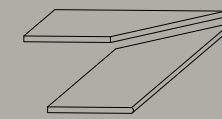

GRADINO ANGOLO ESTERNO BORDO CON TORO
EXT. CORNER STEP TREAD / ANGLE EXT. NEZ DE MARCHE /
AUSSENECKTRITTSTUFE / ANG. EXT. CANTO ROMO
▲ 45x90 (18”x36”) RT 20 mm
▲ 30x60 (12”x24”) RT 20 mm

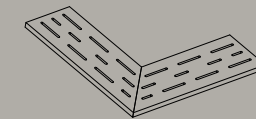

ANGOLARE GRIGLIA
GRID / GRIL / GRILL / ANGULAR REJILLA
▲ 15x60 (6”x24”) RT 20 mm

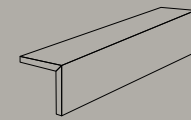

CORDOLO L
GLUED “L” TERMINAL / TERMINAL “L” COLLÉ /
“L” STÜCK FLIESE GEKLEBT / CANTONERA “L” (PEGADA)
▲ 60x20x15 (24”x8”x6”) RT 20 mm

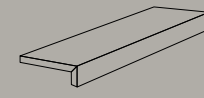

TERMINALE L
GLUED “L” TERMINAL / TERMINAL “L” COLLÉ /
“L” STÜCK FLIESE GEKLEBT / TERMINAL “L” (PEGADO)
▲ 120x45x15 (48”x18”x6”) RT 20 mm
▲ 90x45x15 (36”x18”x6”) RT 20 mm
▲ 60x20x5 (24”x8”x2”) RT 20 mm
▲ 33x60x5 (13”x24”x2”) RT 20 mm

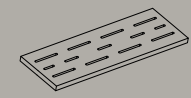

GRIGLIA
GRID / GRIL / GRILL / REJILLA
▲ 15x60 (6”x24”) RT 20 mm

FORMATI

FORMATS / FORMATS / FORMATE / FORMATOS

	60x60 24”x24”	40x60 16”x24”	30x60 12”x24”	20x60 8”x24”	15x30 6”x12”	120x240 (119,5x239)* 48”x96”	30x240 (30x239)* 12”x96”	120x120 (119,5x119,5)* 48”x48”	45x90 18”x36”	60x60 24”x24”	60x60 24”x24”
working size	596x596	396x596	297x596	197x596		1194x2390	297x2390	1194x1194	446x895	596x596	596x596
	RT	RT	RT	RT	Not RT	RT	RT	RT	RT	RT	RT
	9 mm	9 mm	9 mm	9 mm	9 mm	K2 20 mm	K2 20 mm	K2 20 mm	K2 20 mm	K2 20 mm	K3 30 mm
PIETRA DI BRESSA	●▲	●▲	●▲	●▲	▲	▲	▲	▲	▲	▲	▲
PIETRA DI BAGNOLO	●▲	●▲	●▲	●▲	▲	▲	▲	▲	▲	▲	▲
PIETRA DI LAVIS	●▲	●▲	●▲	●▲	▲	▲	▲	▲	▲	▲	▲

*Formato nominale / Nominal size / Format nominal / Nennformat / Formato nominal

● Natural R9 | ▲ Structured R11

alpi

4

COLORI/
COLOURS
COULEURS
FARBE
COLORES

3

FORMATI/
SIZES
FORMATS
FORMATE
FORMATOS

1

SUPERFICI/
FINISHES
FINITIONS
OBERFLÄCHEN
ACABADOS

1

SPESSORI/
THICKNESS
ÉPAISSEUR
STÄRKE
ESPEJOR



STELVIO
30x30 (12"x12") - 15x30 (6"x12") -
15x15 (6"x6")



stone effect | alpi



TONALE
15x15 (6"x6")



SELLA
15x15 (6"x6")

stone effect | alpi

4

COLORI/

COLOURS / COULEURS / FARBE / COLORES

STELVIO V3



TONALE V3



PORDOI V3



SELLA V3



3

FORMATI/

SIZES / FORMATS / FORMATE / FORMATOS



▲ 30x30 (12"x12") Not RT 9 mm



▲ 15x30 (6"x12") Not RT 9 mm



▲ 15x15 (6"x6") Not RT 9 mm

4

PEZZI SPECIALI/

TRIMS / PIECES SPECIALES / FORMTEILE /
PIEZAS ESPECIALES



BATTISCOPA

BULLNOSE / PLINTHE / SOCKEL / RODAPIÉ

▲ 8x30 (3"x12") Not RT 9 mm



SCALINO MONOLITICO

STEP TREAD / NEZ DE MARCHE / STUFENPLATTE / PELDAÑO

▲ 30x33 (12"x13") RT 10 mm

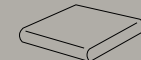

SCALINO ANGOLARE MONOLITICO

STEP TREAD WITH CORNER / CARREAU DE MARCHE PIÈCE ANGULAIRE /
STUFENPLATTE ECKSTÜCK / PELDAÑO ESQUINA

▲ 33x33 (13"x13") RT 10 mm

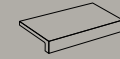

TERMINALE L MONOLITICO

L TERMINAL / TERMINALE ELLE /
L STÜCK FLIESE / REMATE EN FORMA DE L

▲ 30x16,5x3,8 (12"x6^{1/2}"x1^{1/2}") Not RT 10 mm

FORMATI

FORMATS / FORMATS / FORMATE / FORMATOS

	30x30 12"x12"	15x30 6"x12"	15x15 6"x6"
	Not RT 9 mm	Not RT 9 mm	Not RT 9 mm
STELVIO	▲	▲	▲
TONALE	▲	▲	▲
PORDOI	▲	▲	▲
SELLA	▲	▲	▲

▲ Structured R11

▲ Structured R11

back

4

COLORI/
COLOURS
COULEURS
FARBE
COLORES

12

FORMATI/
SIZES
FORMATS
FORMATE
FORMATOS

3

SUPERFICI/
FINISHES
FINITIONS
OBERFLÄCHEN
ACABADOS

3

SPESSORI/
THICKNESS
ÉPAISSEUR
STÄRKE
ESPESOR





BACK ANTHRACITE
60x60 (24"x24") - 40x60 (16"x24") - 30x60 (12"x24")



BACK SILVER
60x60 (24"x24") - LISTELLO UP 9,7x60 (3⁷/₈"x24")

5

COLORI/

COLOURS / COULEURS / FARBE / COLORES

BACK IVORY V2



BACK SILVER V2



BACK GREY V2



BACK ANTHRACITE V2



12

FORMATI/

SIZES / FORMATS / FORMATE / FORMATOS

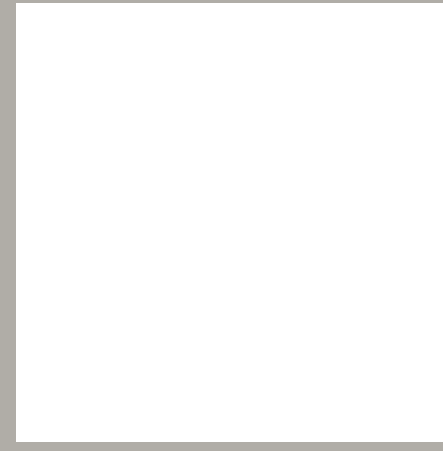

● 120x120 (48"x48") RT 9 mm

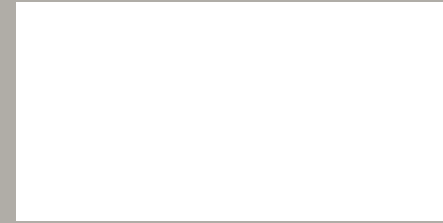

● ▲ 60x120 (24"x48") RT 9 mm

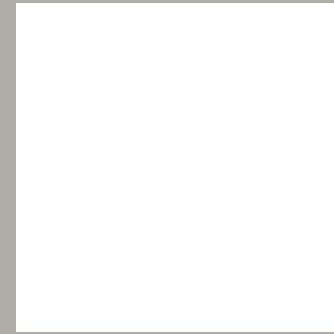

▲ 90x90 (36"x36") RT K2 20 mm

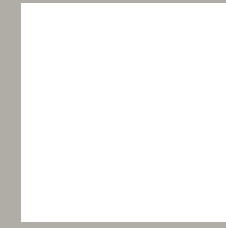

● ▲ 60x60 (24"x24") RT 9 mm
▲ 60x60 (24"x24") RT K2 20 mm



● 40x60 (16"x24") RT 9 mm



● ▲ 30x60 (12"x24") RT 9 mm



● 20x60 (8"x24") RT 9 mm



● 9,7x60 (3 7/8"x24") RT 9 mm

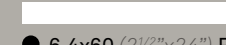

● 6,4x60 (2 1/2"x24") RT 9 mm



● 3,1x60 (1 1/4"x24") RT 9 mm



■ 7,5x30 (3"x12") Not RT 8,5 mm

● Natural R9 | ■ Structured R10 | ▲ Grip R11

stone effect | back

3

DECORI/

DECORS / PIECES SPECIALES / FORMTEILE /
PIEZAS ESPECIALES

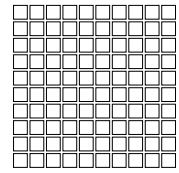

MOSAICO ● 30x30 (12"x12") RT 9 mm
(TESSERE: 2,8x2,8 - 11/16"x11/16")



BACK IVORY



BACK SILVER



BACK GREY



BACK ANTHRACITE



STRIPS ● 30x60 (12"x24") RT 9 mm



BACK IVORY



BACK SILVER



BACK GREY

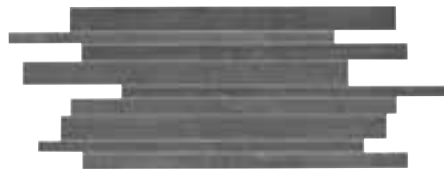

BACK ANTHRACITE



LISTELLO UP ● 9,7x60 (3^{7/8}"x24") RT 9 mm



LISTELLO UP ● 6,4x60 (2^{1/2}"x24") RT 9 mm

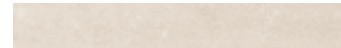

BACK IVORY



BACK IVORY



BACK SILVER



BACK SILVER



BACK GREY



BACK GREY



BACK ANTHRACITE



BACK ANTHRACITE

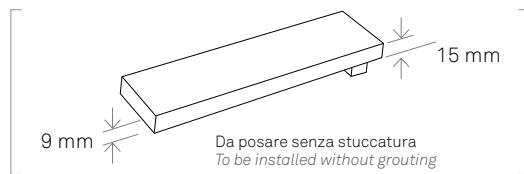

5

PEZZI SPECIALI/

TRIMS / PIECES SPECIALES / FORMTEILE /
PIEZAS ESPECIALES

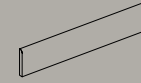

BATTISCOPA
BULLNOSE / PLINTHE / SOCKEL / RODAPIÉ
● 7,2x60 (2,8"x24") RT 9 mm

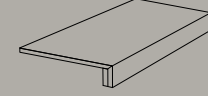

SCALINO CON PROFILO INCOLLATO
GLUED STEP TREAD / NEZ DE MARCHE COLLÉ /
GEKLEBTE STUFENPLATTE / PELDAÑO CON PERFIL PEGADO
● 33x60 (13"x24") RT 9 mm

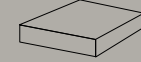

SCALINO ANGOLARE CON PROFILO INCOLLATO
GLUED CORNER STEP TREAD / CARREAU DE MARCHE COLLÉ PIÈCE
ANGULAIRE / GEKLEBTE STUFENPLATTE ECKSTÜCK / PELDAÑO
ESQUINA CON PERFIL PEGADO
● 33x33 (13"x13") RT 9 mm

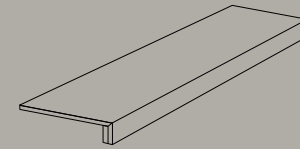

SCALINO INCOLLATO
GLUED STEP TREAD / NEZ DE MARCHE COLLÉ /
GEKLEBTE STUFENPLATTE / PELDAÑO CON PERFIL PEGADO
●▲ 33x120 (13"x48") RT 9 mm

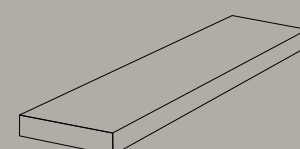

ANGOLARE INCOLLATO
GLUED CORNER STEP TREAD / CARREAU DE MARCHE COLLÉ
PIÈCE ANGULAIRE / GEKLEBTE STUFENPLATTE ECKSTÜCK /
PELDAÑO ESQUINA CON PERFIL PEGADO
●▲ 33x120 (13"x48") RT 9 mm

FORMATI

FORMATS / FORMATS / FORMATE / FORMATOS

	120x240 (119,5x239)* 48"x96"	60x120 24"x48"	60x60 24"x24"	40x60 16"x24"	30x60 12"x24"	20x60 8"x24"	9,7x60 3 ^{7/8} "x24"	6,4x60 2 ^{1/2} "x24"	3,1x60 1 ^{1/4} "x24"	7,5x30 3"x12"	90x90 36"x36"	60x60 24"x24"
working size	1194x1194	596x1195	596x596	396x596	297x596	197x596	97x596	64x596	31x596		895x895	596x596
	RT	RT	RT	RT	RT	RT	RT	RT	RT	Not RT	RT	RT
	9 mm	9 mm	9 mm	9 mm	9 mm	9 mm	9 mm	9 mm	9 mm	8,5mm	K2 20 mm	K2 20 mm
BACK IVORY			●	●	●	●	●	●	●			
BACK SILVER			●	●	●	●	●	●	●			
BACK GREY	●	●▲	●▲	●	●▲	●	●	●	●	■	▲	▲
BACK ANTHRACITE	●	●▲	●▲	●	●▲	●	●	●	●	■	▲	▲

*Formato nominale / Nominal size / Format nominal / Nennformat / Formato nominal

● Natural R9 | ■ Structured R10 | ▲ Grip R11

10

PEZZI SPECIALI K2/

TRIMS K2 / PIECES SPECIALES K2 / FORMTEILE K2 /
PIEZAS ESPECIALES K2

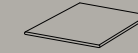

ANGOLARE BORDO CON TORO
CORNER STEP TREAD / NEZ DE MARCHE
ANGULAIRE / STUFENPLATTE ECKSTÜCK /
ANGULAR CANTO ROMO
▲ 30x30 (12"x12") RT 20 mm

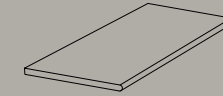

GRADINO BORDO CON TORO
ROUNDED STEP TREAD / NEZ DE MARCHE
ARRONDI / GERUNDET STUFENPLATTE /
PELDAÑO CANTO ROMO
▲ 30x60 (12"x24") RT 20 mm

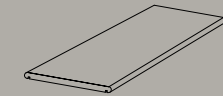

TOP BORDO TORO
TOP STEP TREAD / NEZ DE MARCHE HAUT /
STUFENPLATTE TOP / TOP CANTO ROMO
▲ 30x60 (12"x24") RT 20 mm

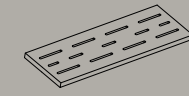

GRIGLIA
GRID / GRIL / GRILL / REJILLA
▲ 15x60 (6"x24") RT 20 mm

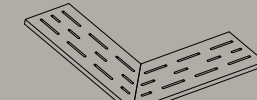

ANGOLARE GRIGLIA
GRID / GRIL / GRILL / ANGULAR REJILLA
▲ 15x60 (6"x24") RT 20 mm

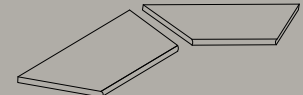

GRADINO ANGOLO INTERNO BORDO CON TORO
INT. CORNER STEP TREAD / ANGLE INT. NEZ DE MARCHE /
INNENECKTRITTSTUFE / ANG. INT. CANTO ROMO
▲ 30x60 (12"x24") RT 20 mm

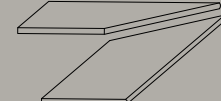

GRADINO ANGOLO ESTERNO BORDO CON TORO
EXT. CORNER STEP TREAD / ANGLE EXT. NEZ DE MARCHE /
AUSSENECKTRITTSTUFE / ANG. EXT. CANTO ROMO
▲ 30x60 (12"x24") RT 20 mm

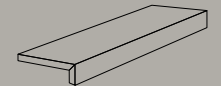

TERMINALE L
GLUED "L" TERMINAL / TERMINAL "L" COLLÉ /
"L" STÜCK FLIESE GEKLEBT / TERMINAL "L" (PEGADO)
▲ 60x20x5 (24"x8" x2") RT 20 mm
▲ 33x60x5 (13"x24" x2") RT 20 mm

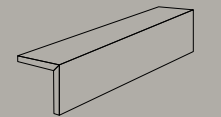

CORDOLO L
GLUED "L" TERMINAL / TERMINAL "L" COLLÉ /
"L" STÜCK FLIESE GEKLEBT / CANTONERA "L" (PEGADA)
▲ 60x20x15 (24"x8" x6") RT 20 mm

code

5

COLORI/
COLOURS
COULEURS
FARBE
COLORES

7

FORMATI/
SIZES
FORMATS
FORMATE
FORMATOS

2

SUPERFICI/
FINISHES
FINITIONS
OBERFLÄCHEN
ACABADOS

1

SPESSORI/
THICKNESS
ÉPAISSEUR
STÄRKE
ESPESOR





CODE TAUPE
60x60 (24"x24")



CODE BEIGE
30x120 (12"x48") - 60x60 (24"x24")
- 40x60 (16"x24") - 20x60 (8"x24")

stone effect | code



CODE IVORY
60x60 (24"x24") - LISTELLO UP 9,7x60 (3,9"x24")

5

COLORI/
COLOURS / COULEURS / FARBE / COLORES

CODE IVORY V2



CODE BEIGE V2



CODE TAUPE V2



CODE GREY V2



CODE ANTHRACITE V2



7

FORMATI/
SIZES / FORMATS / FORMATE / FORMATOS

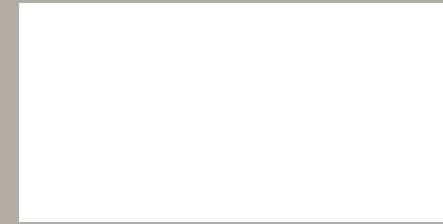

● 60x120 (24"x48") RT 9 mm



● 30x120 (12"x48") RT 9 mm

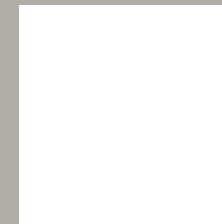

● 60x60 (24"x24") RT 9 mm

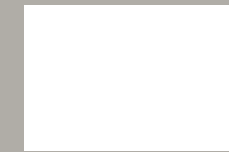

● 40x60 (16"x24") RT 9 mm



● ▲ 30x60 (12"x24") RT 9 mm



● 20x60 (8"x24") RT 9 mm

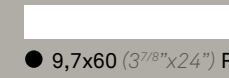

● 9,7x60 (3⁷/₈"x24") RT 9 mm

● Natural R9 | ▲ Grip R11

3

DECORI/

DECORS / PIECES SPECIALES / FORMTEILE /
PIEZAS ESPECIALES

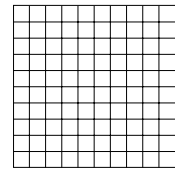

MOSAICO ● 30x30 (12"x12") RT 9 mm
(TESSERE: 2,8x2,8 - 1 1/8"x1 1/8")



CODE IVORY



CODE BEIGE



CODE TAUPE



CODE GREY

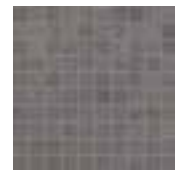

CODE ANTHRACITE



STRIPS ● 30x60 (12"x24") RT 9 mm



CODE IVORY



CODE BEIGE



CODE TAUPE



CODE GREY



CODE ANTHRACITE

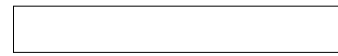

LISTELLO UP ● 9,7x60 (3 7/8"x24") RT 9 mm



CODE IVORY



CODE BEIGE

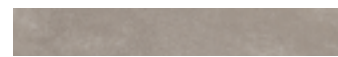

CODE TAUPE



CODE GREY



CODE ANTHRACITE

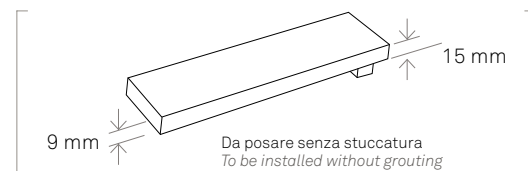

5

PEZZI SPECIALI/

TRIMS / PIECES SPECIALES / FORMTEILE /
PIEZAS ESPECIALES

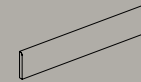

BATTISCOPA
BULLNOSE / PLINTHE / SOCKEL / RODAPIÉ
● 7,2x60 (2,8"x24") RT 9 mm

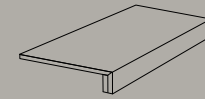

SCALINO CON PROFILO INCOLLATO
GLUED STEP TREAD / NEZ DE MARCHE COLLÉ /
GEKLEBTE STUFENPLATTE / PELDAÑO CON PERFIL PEGADO
● 33x60 (13"x24") RT 9 mm



SCALINO ANGOLARE CON PROFILO INCOLLATO
GLUED CORNER STEP TREAD / CARREAU DE MARCHE COLLÉ PIÈCE
ANGULAIRE / GEKLEBTE STUFENPLATTE ECKSTÜCK / PELDAÑO
ESQUINA CON PERFIL PEGADO
● 33x33 (13"x13") RT 9 mm

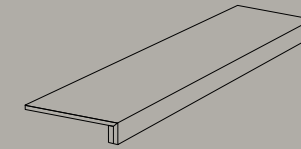

SCALINO INCOLLATO
GLUED STEP TREAD / NEZ DE MARCHE COLLÉ /
GEKLEBTE STUFENPLATTE / PELDAÑO CON PERFIL PEGADO
● 33x120 (13"x48") RT 9 mm

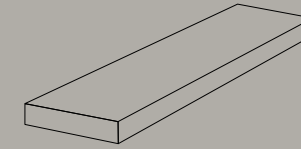

ANGOLARE INCOLLATO
GLUED CORNER STEP TREAD / CARREAU DE MARCHE COLLÉ
PIÈCE ANGULAIRE / GEKLEBTE STUFENPLATTE ECKSTÜCK /
PELDAÑO ESQUINA CON PERFIL PEGADO
● 33x120 (13"x48") RT 9 mm

FORMATI

FORMATS / FORMATS / FORMATE / FORMATOS

	60x120 24"x48"	30x120 12"x48"	60x60 24"x24"	40x60 16"x24"	30x60 12"x24"	20x60 8"x24"	9,7x60 3 7/8"x24"
working size	596x1195	297x1195	596x596	396x596	297x596	197x596	97x596
	RT	RT	RT	RT	RT	RT	RT
	9 mm	9 mm	9 mm	9 mm	9 mm	9 mm	9 mm
CODE IVORY	●	●	●	●	●▲	●	●
CODE BEIGE	●	●	●	●	●▲	●	●
CODE TAUPE	●	●	●	●	●▲	●	●
CODE GREY	●	●	●	●	●▲	●	●
CODE ANTHRACITE	●	●	●	●	●▲	●	●

● Natural R9 | ▲ Grip R11

langhe

5

COLORI/
COLOURS
COULEURS
FARBE
COLORES

1

FORMATI/
SIZES
FORMATS
FORMATE
FORMATOS

1

SUPERFICI/
FINISHES
FINITIONS
OBERFLÄCHEN
ACABADOS

1

SPESSORI/
THICKNESS
ÉPAISSEUR
STÄRKE
ESPESOR



stone effect | langhe

5

COLORI/ COLOURS / COULEURS / FARBE / COLORES

GAVI **V2**



CORTEMILIA **V2**



BRA **V2**



BAROLO **V2**



MONFORTE **V2**



1

FORMATO/ SIZES / FORMATS / FORMATE / FORMATOS



■ 15x15 (6"x6") Not RT 9 mm

1

PEZZI SPECIALI/ TRIMS / PIECES SPECIALES / FORMTEILE / PIEZAS ESPECIALES



TERMINALE L MONOLITICO

L TERMINAL / TERMINALE ELLE /
L STÜCK FLIESE / REMATE EN FORMA DE L

■ 30x3,8x16,5 (12"x1 1/2"x6 1/2") Not RT 10 mm

FORMATI FORMATS / FORMATS / FORMATE / FORMATOS

	15x15 6"x6"
	Not RT 9 mm
BAROLO	■
BRA	■
CORTEMILIA	■
GAVI	■
MONFORTE	■

■ Structured R10

pietre di keope

4

COLORI/
COLOURS
COULEURS
FARBE
COLORES

1

FORMATI/
SIZES
FORMATS
FORMATE
FORMATOS

1

SUPERFICI/
FINISHES
FINITIONS
OBERFLÄCHEN
ACABADOS

1

SPESSORI/
THICKNESS
ÉPAISSEUR
STÄRKE
ESPESOR



4

COLORI/

COLOURS / COULEURS / FARBE / COLORES

NAXOS V2



SELCE V2



COGNE V2



BASALTO V2



LEED
COMPLIANT

1

FORMATO/

SIZES / FORMATS / FORMATE / FORMATOS



▲ 30x30 (12"x12") Not RT 8,6 mm

2

PEZZI SPECIALI/

TRIMS / PIECES SPECIALES / FORMTEILE /
PIEZAS ESPECIALES



BATTISCOPIA

BULLNOSE / PLINTHE / SOCKEL / RODAPIÉ

▲ 8x30 (3"x12") Not RT 8,6 mm

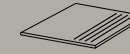

GRADINO

STEP TREAD / NEZ DE MARCHE /
STUFENPLATTE / PELDAÑO

▲ 30x30 (12"x12") Not RT 8,6 mm

FORMATI

FORMATS / FORMATS / FORMATE / FORMATOS

	30x30 12"x12"
	Not RT
	8,6 mm
NAXOS	▲
SELCE	▲
COGNE	▲
BASALTO	▲

▲ Structured R11

stone effect | pietre di keope

point

4

COLORI/
COLOURS
COULEURS
FARBE
COLORES

4

FORMATI/
SIZES
FORMATS
FORMATE
FORMATOS

1

SUPERFICI/
FINISHES
FINITIONS
OBERFLÄCHEN
ACABADOS

1

SPESSORI/
THICKNESS
ÉPAISSEUR
STÄRKE
ESPEJOR





POINT SILVER
30x60 (12"x24")



POINT BEIGE MULTICOLOR
30x30 (12"x12") - 15x30 (6"x12") - 15x15 (6"x6")

4

COLORI/

COLOURS / COULEURS / FARBE / COLORES

POINT SILVER **V3**



POINT BEIGE MULTICOLOR **V4**



POINT GREY MULTICOLOR **V4**



POINT SAND **V3**



4

FORMATI/

SIZES / FORMATS / FORMATE / FORMATOS



▲ 30x60 (12"x24") Not RT 9 mm



▲ 30x30 (12"x12") Not RT 9 mm



▲ 15x30 (6"x12") Not RT 9 mm



▲ 15x15 (6"x6") Not RT 9 mm

4

PEZZI SPECIALI/

TRIMS / PIECES SPECIALES / FORMTEILE /
PIEZAS ESPECIALES



BATTISCOPA
BULLNOSE / PLINTHE / SOCKEL / RODAPIÉ
▲ 8x30 (3"x12") Not RT 9 mm



SCALINO MONOLITICO
STEP TREAD / NEZ DE MARCHE / STUFENPLATTE / PELDAÑO
▲ 30x33 (13"x13") RT 10 mm

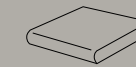

SCALINO ANGOLARE MONOLITICO
STEP TREAD WITH CORNER / CARREAU DE
MARCHE PIÈCE ANGULAIRE / STUFENPLATTE
ECKSTÜCK / PELDAÑO ESQUINA
▲ 33x33 (13"x13") RT 10 mm

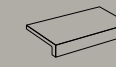

TERMINALE L MONOLITICO
L TERMINAL / TERMINALE ELLE /
L STÜCK FLIESE / REMATE EN FORMA DE L
▲ 30x3,8x16,5 (12"x1 1/2"x6 1/2") Not RT 10 mm

FORMATI

FORMATS / FORMATS / FORMATE / FORMATOS

	30x60 12"x24"	30x30 12"x12"	15x30 6"x12"	15x15 6"x6"
	Not RT 9 mm	Not RT 9 mm	Not RT 9 mm	Not RT 9 mm
POINT SILVER	▲	▲	▲	▲
POINT BEIGE MULTICOLOR	▲	▲	▲	▲
POINT GREY MULTICOLOR	▲	▲	▲	▲
POINT SAND	▲	▲	▲	▲

▲ Structured R11

sight

3

COLORI/
COLOURS
COULEURS
FARBE
COLORES

1

FORMATI/
SIZES
FORMATS
FORMATE
FORMATOS

1

SUPERFICI/
FINISHES
FINITIONS
OBERFLÄCHEN
ACABADOS

1

SPESSORI/
THICKNESS
ÉPAISSEUR
STÄRKE
ESPEJOR



3

COLORI/

COLOURS / COULEURS / FARBE / COLORES

SIGHT ANTHRACITE V3



SIGHT GREY V3



SIGHT BEIGE V2



1

FORMATI/

SIZES / FORMATS / FORMATE / FORMATOS

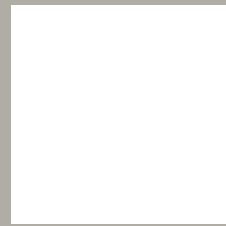

▲ 60x60 (24"x24") RT K2 20 mm

10

PEZZI SPECIALI K2/

TRIMS K2 / PIECES SPECIALES K2 / FORMTEILE K2 / PIEZAS ESPECIALES K2

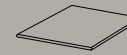

ANGOLARE BORDO CON TORO
CORNER STEP TREAD / NEZ DE MARCHE ANGULAIRE / STUFENPLATTE ECKSTÜCK / ANGULAR CANTO ROMO
▲ 30x30 (12"x12") RT 20 mm

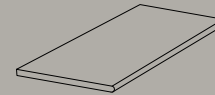

GRADINO BORDO CON TORO
ROUNDED STEP TREAD / NEZ DE MARCHE ARRONDI / GERUNDET STUFENPLATTE / PELDAÑO CANTO ROMO
▲ 30x60 (12"x24") RT 20 mm

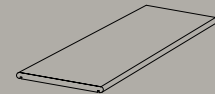

TOP BORDO TORO
TOP STEP TREAD / NEZ DE MARCHE HAUT / STUFENPLATTE TOP / TOP CANTO ROMO
▲ 30x60 (12"x24") RT 20 mm

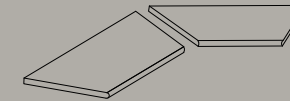

GRADINO ANGOLO INTERNO BORDO CON TORO
INT. CORNER STEP TREAD / ANGLE INT. NEZ DE MARCHE / INNENECKTRITTSTUFE / ANG. INT. CANTO ROMO
▲ 30x60 (12"x24") RT 20 mm

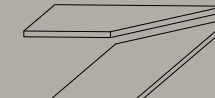

GRADINO ANGOLO ESTERNO BORDO CON TORO
EXT. CORNER STEP TREAD / ANGLE EXT. NEZ DE MARCHE / AUSSENECKTRITTSTUFE / ANG. EXT. CANTO ROMO
▲ 30x60 (12"x24") RT 20 mm

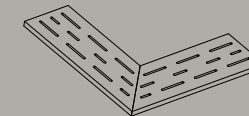

ANGOLARE GRIGLIA
GRID / GRIL / GRILL / ANGULAR REJILLA
▲ 15x60 (6"x24") RT 20 mm

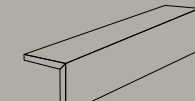

CORDOLO L
GLUED "L" TERMINAL / TERMINAL "L" COLLÉ / "L" STÜCK FLIESE GEKLEBT / CANTONERA "L" (PEGADA)
▲ 60x20x15 (24"x8"x6") RT 20 mm

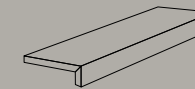

TERMINALE L
GLUED "L" TERMINAL / TERMINAL "L" COLLÉ / "L" STÜCK FLIESE GEKLEBT / TERMINAL "L" (PEGADO)
▲ 60x20x5 (24"x8"x2") RT 20 mm
▲ 33x60x5 (13"x24"x2") RT 20 mm

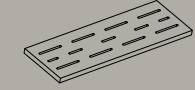

GRIGLIA
GRID / GRIL / GRILL / REJILLA
▲ 15x60 (6"x24") RT 20 mm

FORMATI

FORMATS / FORMATS / FORMATE / FORMATOS

	60x60 24"x24"
working size	596x596
	RT
	K2 20 mm
SIGHT ANTHRACITE	▲
SIGHT GREY	▲
SIGHT BEIGE	▲

▲ Structured R11

▲ Structured R11

sunrise

5

COLORI/
COLOURS
COULEURS
FARBE
COLORES

5

FORMATI/
SIZES
FORMATS
FORMATE
FORMATOS

1

SUPERFICI/
FINISHES
FINITIONS
OBERFLÄCHEN
ACABADOS

1

SPESSORI/
THICKNESS
ÉPAISSEUR
STÄRKE
ESPEJOR





SUNRISE SMOKE
30x60 (12"x24")



SUNRISE QUARTZ
60x60 (24"x24") - 20x60 (8"x24")

stone effect | sunrise

5

COLORI/ COLOURS / COULEURS / FARBE / COLORES

QUARTZ V1



GOLDEN V1



CABERNET V1



COFFEE V1



SMOKE V1



1

DECORI/ DECORS / PIECES SPECIALES / FORMTEILE / PIEZAS ESPECIALES

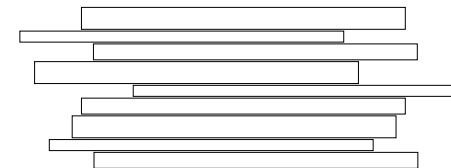

STRIPS ■ 30x60 (12"x24") RT 9 mm



QUARTZ



GOLDEN



CABERNET



COFFEE



SMOKE

5

FORMATI/ SIZES / FORMATS / FORMATE / FORMATOS

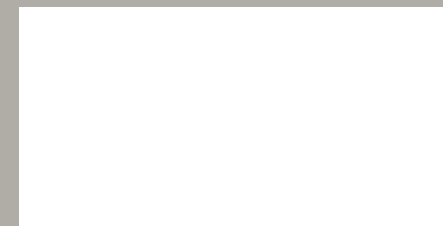

■ 60x120 (24"x48") RT 9 mm

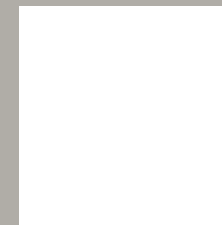

■ 60x60 (24"x24") RT 9 mm

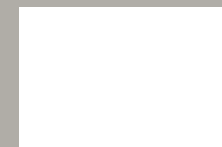

■ 40x60 (16"x24") RT 9 mm



■ 30x60 (12"x24") RT 9 mm



■ 20x60 (8"x24") RT 9 mm

1

PEZZI SPECIALI/ TRIMS / PIECES SPECIALES / FORMTEILE / PIEZAS ESPECIALES



BATTISCOPA
BULLNOSE / PLINTHE / SOCKEL / RODAPIÉ
■ 7,2x60 (2,8"x24") RT 9 mm

FORMATI FORMATS / FORMATS / FORMATE / FORMATOS

	60x120 24"x48"	60x60 24"x24"	40x60 16"x24"	30x60 12"x24"	20x60 8"x24"
working size	596x1195	596x596	396x596	297x596	197x596
	RT	RT	RT	RT	RT
	9 mm	9 mm	9 mm	9 mm	9 mm
SUNRISE QUARTZ	■	■	■	■	■
SUNRISE GOLDEN		■	■	■	■
SUNRISE SMOKE		■	■	■	■
SUNRISE CABERNET		■	■	■	■
SUNRISE COFFEE		■	■	■	■

■ Grip R10

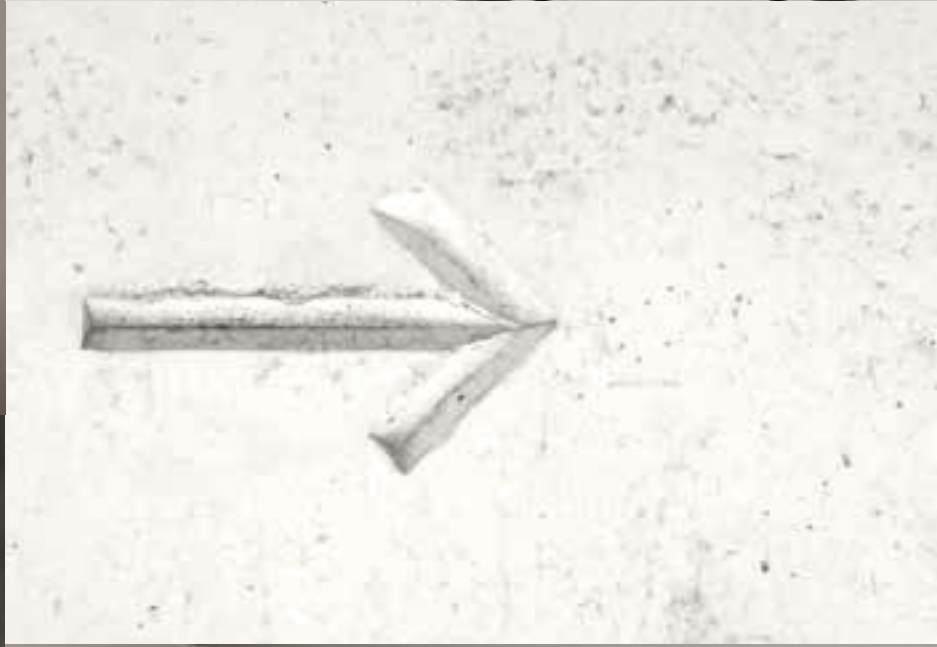

concrete & design

EFFECT

208 / Noord

218 / Ikon

228 / Moov

240 / Cementeine

246 / Elements Design

noord

5

COLORI/
COLOURS
COULEURS
FARBE
COLORES

10

FORMATI/
SIZES
FORMATS
FORMATE
FORMATOS

2

SUPERFICI/
FINISHES
FINITIONS
OBERFLÄCHEN
ACABADOS

2

SPESSORI/
THICKNESS
ÉPAISSEUR
STÄRKE
ESPESOR





NOORD GREY
120x120 (48"x48") K2 20 mm -
DECORO DOCKS 30x60 (12"x24") RT 9 mm

NOORT TAUPE
120x120 (48"x48")



NOORD GOLD
120x120 (48"x48")

5

COLORI/
COLOURS / COULEURS / FARBE / COLORES

NOORD GREY **V2**



NOORD ANTHRACITE **V2**



NOORD TAUPE **V2**



NOORD WHITE **V2**



NOORD GOLD **V2**



10

FORMATI/
SIZES / FORMATS / FORMATE / FORMATOS



- 120x120 (48"x48") RT 9 mm
- ▲ 120x120 (48"x48") RT ➔ **K2** 20 mm

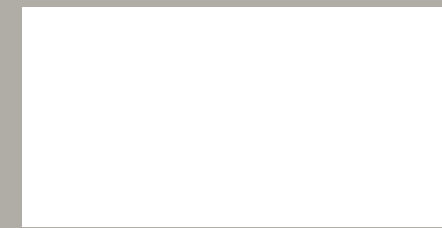

- 60x120 (24"x48") RT 9 mm



- 30x120 (12"x48") RT 9 mm

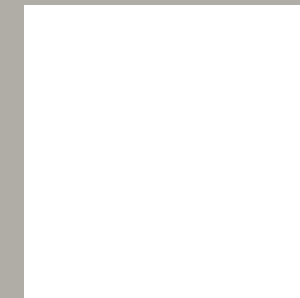

- 80x80 (32"x32") RT 9 mm

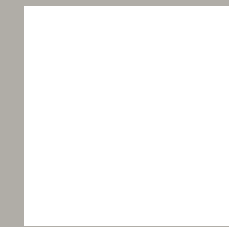

- 60x60 (24"x24") RT 9 mm
- ▲ 60x60 (24"x24") RT ➔ **K2** 20 mm



- 30x60 (12"x24") RT 9 mm
- ▲ 30x60 (12"x24") RT ➔ **K2** 20 mm



- 9,7x60 (3^{7/8}"x24") RT 9 mm

● Natural R10 | ▲ Grip R11

3

DECORI/

DECORS / PIECES SPECIALES / FORMTEILE /
PIEZAS ESPECIALES

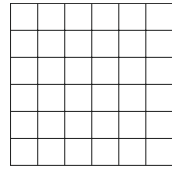

MOSAICO ■ 30x30 (12"x12") RT 9 mm
(TESSERE: 4,8x4,8 - 17/8"x17/8")



NOORD GREY



NOORD ANTHRACITE



NOORD TAUPE



NOORD WHITE



NOORD GOLD

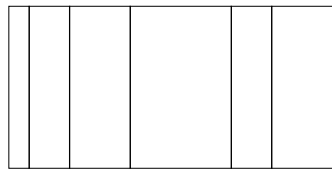

DECORO DOCKS
■ 30x60 (12"x24") RT 9 mm



NOORD GREY



NOORD ANTHRACITE



NOORD TAUPE



NOORD WHITE



NOORD GOLD



LISTELLO UP ■ 9,7x60 (37/8"x24") RT 9 mm



NOORD GREY



NOORD ANTHRACITE



NOORD TAUPE



NOORD WHITE



NOORD GOLD

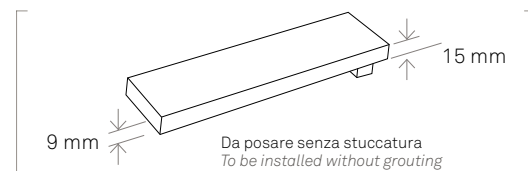

7

PEZZI SPECIALI/

TRIMS / PIECES SPECIALES / FORMTEILE /
PIEZAS ESPECIALES

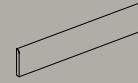

BATTISCOPA
BULLNOSE / PLINTHE / SOCKEL / RODAPIÉ
■ 4,6x120 (213/16"x48") RT 9 mm
■ 7x80 (23/4"x32") RT 9 mm
■ 7,2x60 (2.8"x24") RT 9 mm

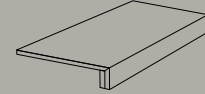

SCALINO INCOLLATO
GLUED STEP TREAD / NEZ DE MARCHE COLLÉ
GEKLEBTE STUFENPLATTE / PELDAÑO CON PERFIL PEGADO
■ 33x60 (13"x24") RT 9 mm



ANGOLARE INCOLLATO GLUED CORNER STEP TREAD / CARREAU
DE MARCHE COLLÉ PIÈCE ANGULAIRE / GEKLEBTE STUFENPLATTE
ECKSTÜCK / PELDAÑO ESQUINA CON PERFIL PEGADO
■ 33x33 (13"x13") RT 9 mm

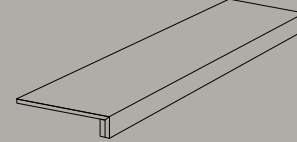

SCALINO CON PROFILO INCOLLATO
GLUED STEP TREAD / NEZ DE MARCHE COLLÉ
GEKLEBTE STUFENPLATTE / PELDAÑO CON PERFIL PEGADO
■ 33x120 (13"x48") RT 9 mm

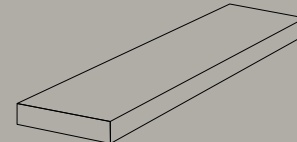

SCALINO ANGOLARE CON PROFILO INCOLLATO
GLUED CORNER STEP TREAD / CARREAU DE MARCHE COLLÉ PIÈCE
ANGULAIRE / GEKLEBTE STUFENPLATTE ECKSTÜCK / PELDAÑO
ESQUINA CON PERFIL PEGADO
■ 33x120 (13"x48") RT 9 mm

FORMATI

FORMATS / FORMATS / FORMATE / FORMATOS

	120x120 (119,5x119,5)* 48"x48"	60x120 24"x48"	30x120 12"x48"	80x80 32"x32"	60x60 24"x24"	30x60 12"x24"	9,7x60 37/8"x24"	120x120 (119,5x119,5)* 48"x48"	60x60 24"x24"	30x60 12"x24"
working size	1194x1194	596x1195	297x1195	795x795	596x596	297x596	97x596	1194x1194	596x596	297x596
	RT 9 mm	RT 9 mm	RT 9 mm	RT 9 mm	RT 9 mm	RT 9 mm	RT 9 mm	RT 20 mm	RT 20 mm	RT 20 mm
NOORD ANTHRACITE	■	■	■	■	■	■	■		▲	▲
NOORD GREY	■	■	■	■	■	■	■	▲	▲	▲
NOORD TAUPE	■	■	■	■	■	■	■			
NOORD GOLD	■	■	■	■	■	■	■		▲	▲
NOORD WHITE	■	■	■	■	■	■	■	▲	▲	▲

*Formato nominale / Nominal size / Format nominal / Nennformat / Formato nominal

■ Natural R10 | ▲ Grip R11

17

PEZZI SPECIALI K2/

TRIMS K2 / PIECES SPECIALES K2 / FORMTEILE K2 /
PIEZAS ESPECIALES K2



ANGOLARE BORDO CON TORO
CORNER STEP TREAD / NEZ DE MARCHE
ANGULAIRE / STUFENPLATTE ECKSTÜCK /
ANGULAR CANTO ROMO
▲ 30x30 (12"x12") RT 20 mm

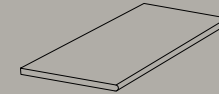

GRADINO BORDO CON TORO
ROUNDED STEP TREAD / NEZ DE MARCHE
ARRONDI / GERUNDET STUFENPLATTE /
PELDAÑO CANTO ROMO
▲ 60x120 (24"x48") RT 20 mm
▲ 30x120 (12"x48") RT 20 mm
▲ 30x60 (12"x24") RT 20 mm

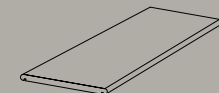

TOP BORDO TORO
TOP STEP TREAD / NEZ DE MARCHE HAUT /
STUFENPLATTE TOP / TOP CANTO ROMO
▲ 30x60 (12"x24") RT 20 mm

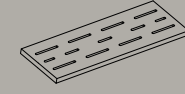

GRIGLIA
GRID / GRIL / GRILL / REJILLA
▲ 15x60 (6"x24") RT 20 mm

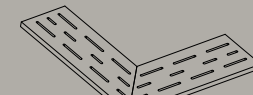

ANGOLARE GRIGLIA
GRID / GRIL / GRILL / ANGULAR REJILLA
▲ 15x60 (6"x24") RT 20 mm

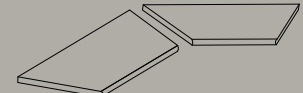

GRADINO ANGOLO INTERNO BORDO CON TORO
INT. CORNER STEP TREAD / ANGLE INT. NEZ DE MARCHE /
INNENECKTRITTSTUFE / ANG. INT. CANTO ROMO
▲ 60x120 (24"x48") RT 20 mm
▲ 30x120 (12"x48") RT 20 mm
▲ 30x60 (12"x24") RT 20 mm

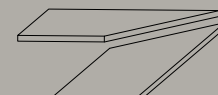

GRADINO ANGOLO ESTERNO BORDO CON TORO
EXT. CORNER STEP TREAD / ANGLE EXT. NEZ DE MARCHE /
AUSSENECKTRITTSTUFE / ANG. EXT. CANTO ROMO
▲ 60x120 (24"x48") RT 20 mm
▲ 30x120 (12"x48") RT 20 mm
▲ 30x60 (12"x24") RT 20 mm

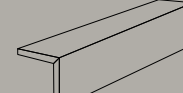

CORDOLO L
GLUED "L" TERMINAL / TERMINAL "L" COLLÉ /
"L" STÜCK FLIESE GEKLEBT / CANTONERA "L" (PEGADA)
▲ 60x20x15 (24"x8" x6") RT 20 mm

ikon

5

COLORI/
COLOURS
COULEURS
FARBE
COLORES

10

FORMATI/
SIZES
FORMATS
FORMATE
FORMATOS

3

SUPERFICI/
FINISHES
FINITIONS
OBERFLÄCHEN
ACABADOS

3

SPESSORI/
THICKNESS
ÉPAISSEUR
STÄRKE
ESPESOR



IKON BEIGE
120X120 (48"x48") - 60x120 (24"x48")

PERCORSI EXTRA PIETRA DI BRESSA
120X120 (48"x48") K2 20mm

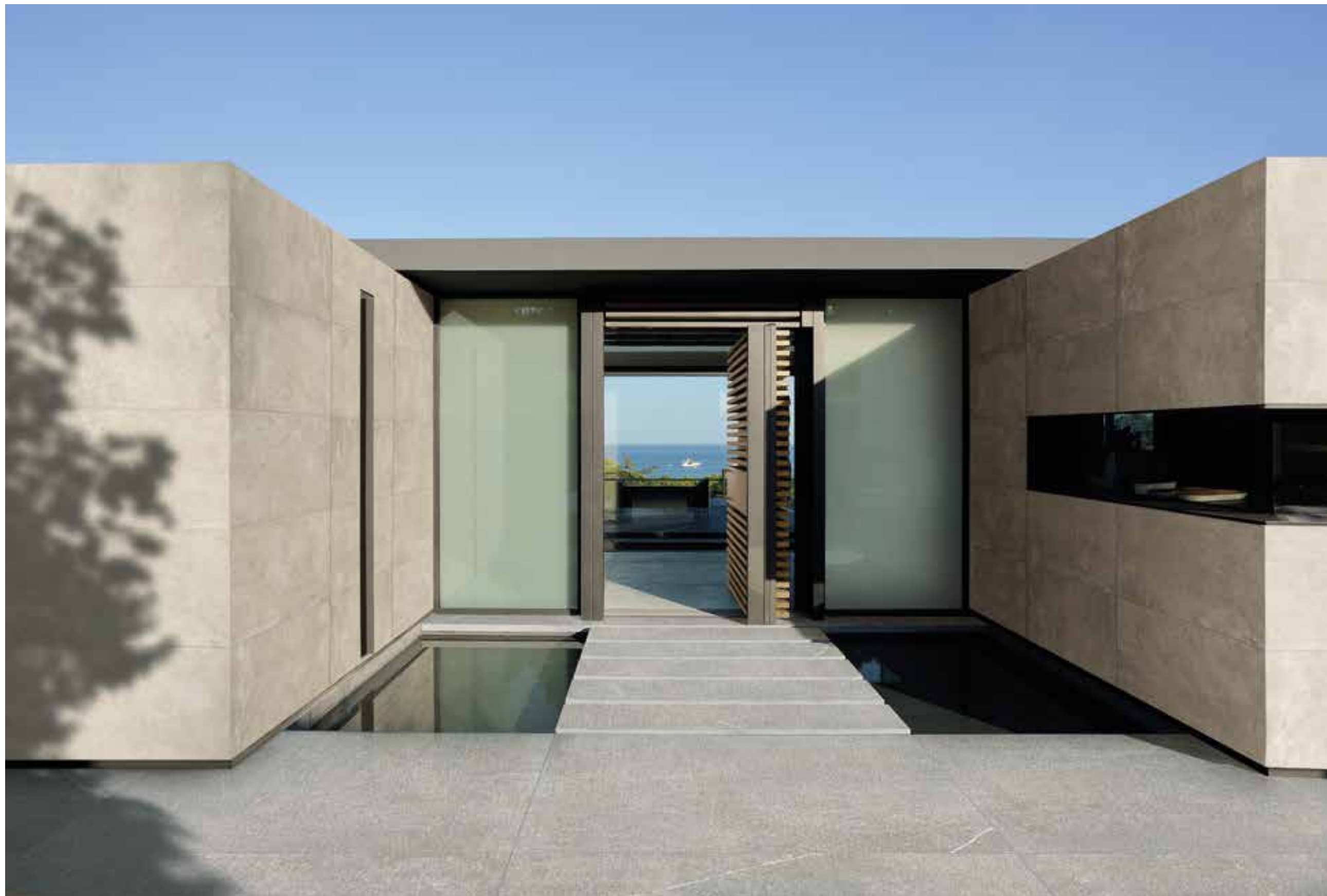

IKON GREY
120x120 (48"x48") - 120x278 (48"x110")



5

COLORI/

COLOURS / COULEURS / FARBE / COLORES

IKON GREY V2



IKON SILVER V2



IKON SKY V2



IKON WHITE V2



IKON BEIGE V2



10

FORMATI/

SIZES / FORMATS / FORMATE / FORMATOS

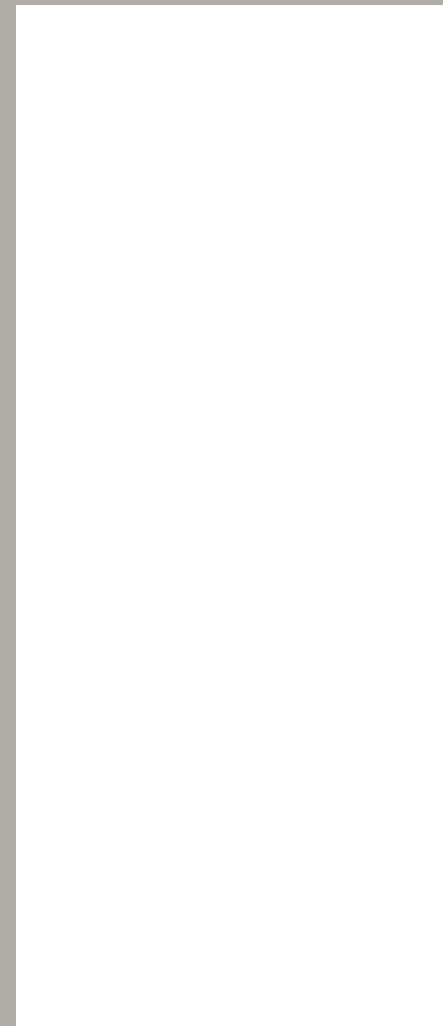

● 120x278 (48"x110") RT 6 mm



● 120x120 (48"x48") RT 9 mm

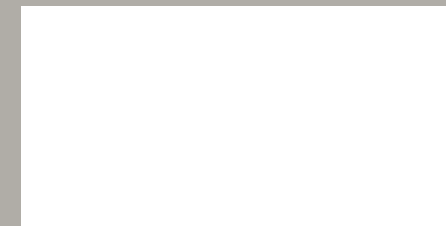

● 60x120 (24"x48") RT 9 mm



● 30x120 (12"x48") RT 9 mm

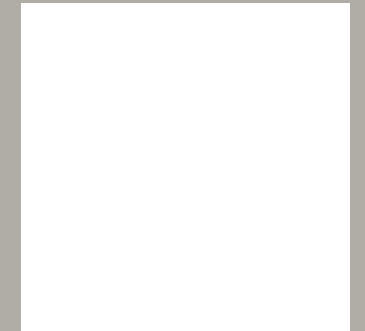

● 90x90 (36"x36") RT 9 mm
▲ 90x90 (36"x36") RT K2 20 mm

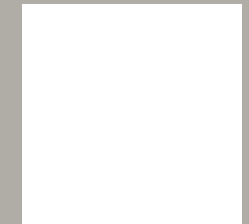

● 60x60 (24"x24") RT 9 mm
▲ 60x60 (24"x24") RT K2 20 mm

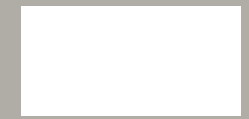

▲ 30x60 (12"x24") RT 9 mm



■ 9,7x60 (3^{7/8}"x24") RT 9 mm

● Natural R9 | ■ Grip R10 | ▲ Grip R11

2

DECORI/

DECORS / PIECES SPECIALES / FORMTEILE /
PIEZAS ESPECIALES

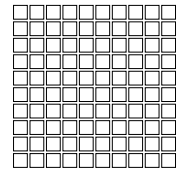

MOSAICO ● 30x30 (12"x12") RT 9 mm
(TESSERE: 2,8x2,8 - 11/16"x11/16")



IKON GREY

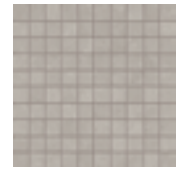

IKON SILVER

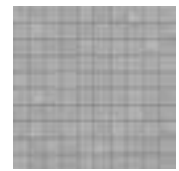

IKON SKY

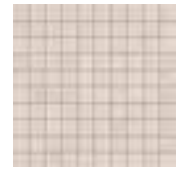

IKON WHITE



IKON BEIGE

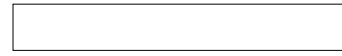

LISTELLO UP ■ 9,7x60 (37/8"x24") RT 9 mm



IKON GREY



IKON SILVER



IKON SKY



IKON WHITE

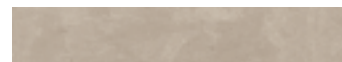

IKON BEIGE

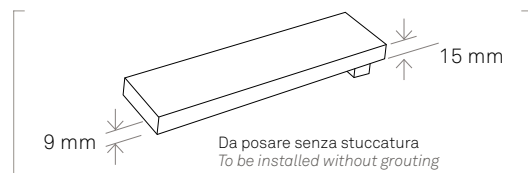

5

PEZZI SPECIALI/

TRIMS / PIECES SPECIALES / FORMTEILE /
PIEZAS ESPECIALES

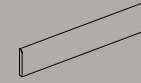

BATTISCOPA
BULLNOSE / PLINTHE / SOCKEL / RODAPIÉ
● 7,2x60 (2.8"x24") RT 9 mm

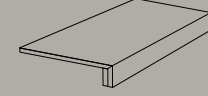

SCALINO INCOLLATO
GLUED STEP TREAD / NEZ DE MARCHE COLLÉ
GEKLEBTE STUFENPLATTE / PELDAÑO CON PERFIL PEGADO
●■ 33x60 (13"x24") RT 9 mm



ANGOLARE INCOLLATO GLUED CORNER STEP TREAD / CARREAU
DE MARCHE COLLÉ PIÈCE ANGULAIRE / GEKLEBTE STUFENPLATTE
ECKSTÜCK / PELDAÑO ESQUINA CON PERFIL PEGADO
●■ 33x33 (13"x13") RT 9 mm

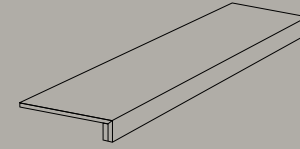

SCALINO CON PROFILO INCOLLATO
GLUED STEP TREAD / NEZ DE MARCHE COLLÉ
GEKLEBTE STUFENPLATTE / PELDAÑO CON PERFIL PEGADO
●■ 33x120 (13"x48") RT 9 mm

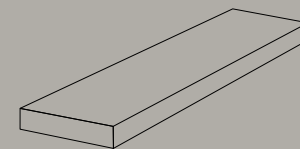

SCALINO ANGOLARE CON PROFILO INCOLLATO
GLUED CORNER STEP TREAD / CARREAU DE MARCHE COLLÉ PIÈCE
ANGULAIRE / GEKLEBTE STUFENPLATTE ECKSTÜCK / PELDAÑO
ESQUINA CON PERFIL PEGADO
●■ 33x120 (13"x48") RT 9 mm

10

PEZZI SPECIALI K₂/

TRIMS K₂ / PIECES SPECIALES K₂ / FORMTEILE K₂ /
PIEZAS ESPECIALES K₂



ANGOLARE BORDO CON TORO
CORNER STEP TREAD / NEZ DE MARCHE
ANGULAIRE / STUFENPLATTE ECKSTÜCK /
ANGULAR CANTO ROMO
▲ 30x30 (12"x12") RT 20 mm

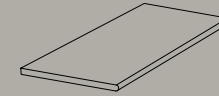

GRADINO BORDO CON TORO
ROUNDED STEP TREAD / NEZ DE MARCHE
ARRONDI / GERUNDET STUFENPLATTE /
PELDAÑO CANTO ROMO
▲ 30x60 (12"x24") RT 20 mm

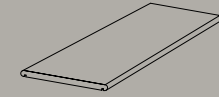

TOP BORDO TORO
TOP STEP TREAD / NEZ DE MARCHE HAUT /
STUFENPLATTE TOP / TOP CANTO ROMO
▲ 30x60 (12"x24") RT 20 mm

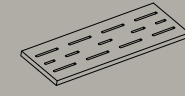

GRIGLIA
GRID / GRIL / GRILL / REJILLA
▲ 15x60 (6"x24") RT 20 mm

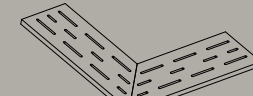

ANGOLARE GRIGLIA
GRID / GRIL / GRILL / ANGULAR REJILLA
▲ 15x60 (6"x24") RT 20 mm

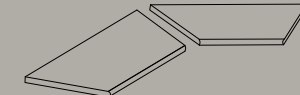

GRADINO ANGOLO INTERNO BORDO CON TORO
INT. CORNER STEP TREAD / ANGLE INT. NEZ DE MARCHE /
INNENECKTRITTSTUFE / ANG. INT. CANTO ROMO
▲ 30x60 (12"x24") RT 20 mm

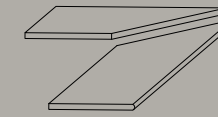

GRADINO ANGOLO ESTERNO BORDO CON TORO
EXT. CORNER STEP TREAD / ANGLE ÉXT. NEZ DE MARCHE /
AUSSENECKTRITTSTUFE / ANG. EXT. CANTO ROMO
▲ 30x60 (12"x24") RT 20 mm

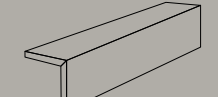

CORDOLO L
GLUED "L" TERMINAL / TERMINAL "L" COLLÉ /
"L" STÜCK FLIESE GEKLEBT / CANTONERA "L" (PEGADA)
▲ 60x20x15 (24"x8"x6") RT 20 mm

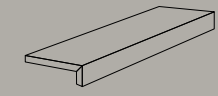

TERMINALE L
GLUED "L" TERMINAL / TERMINAL "L" COLLÉ /
"L" STÜCK FLIESE GEKLEBT / TERMINAL "L" (PEGADO)
▲ 60x20x5 (24"x8"x2") RT 20 mm
▲ 33x60x5 (13"x24"x2") RT 20 mm

FORMATI

SIZES / FORMATS / FORMATE / FORMATOS

	120x278 (119,5x278)* 48"x110"	120x120 (119,5x119,5)* 48"x48"	60x120 24"x48"	30x120 12"x48"	90x90 36"x36"	60x60 24"x24"	30x60 12"x24"	9,7x60 30,9"x24"	90x90 36"x36"	60x60 24"x24"
working size	1194x2778	1194x1194	596x1195	297x1195	895x895	596x596	297x596	97x596	895x895	596x596
	RT	RT	RT	RT	RT	RT	RT	RT	RT	RT
	6 mm	9 mm	9 mm	9 mm	9 mm	9 mm	9 mm	9 mm	K2 20 mm	K2 20 mm
IKON GREY	●	●■	●■	●■	●	●■	■▲	■		
IKON SILVER	●	●■	●■	●■	●	●■	■▲	■	▲	▲
IKON WHITE		●■	●■	●■	●	●■	■▲	■	▲	▲
IKON SKY		●■	●■	●■	●	●■	■▲	■		
IKON BEIGE		●■	●■	●■	●	●■	■▲	■	▲	▲

*Formato nominale / Nominal size / Format nominal / Nennformat / Formato nominal

● Natural R9 | ■ Grip R10 | ▲ Grip R11

moov

5

COLORI/
COLOURS
COULEURS
FARBE
COLORES

19

FORMATI/
SIZES
FORMATS
FORMATE
FORMATOS

4

SUPERFICI/
FINISHES
FINITIONS
OBERFLÄCHEN
ACABADOS

4

SPESSORI/
THICKNESS
ÉPAISSEUR
STÄRKE
ESPESOR



MOOV MOKA
75x75 (30"x30")



MOOV ANTHRACITE
20x120 (8"x48")

MOOV IVORY
120x278 (48"x110") - 120x120 (48"x48") -
MOSAICO 30x30 (12"x12")



5

COLORI/

COLOURS / COULEURS / FARBE / COLORES

MOOV ANTHRACITE V2



MOOV GREY V2



MOOV MOKA V2



MOOV IVORY V2



MOOV BEIGE V2



19

FORMATI/

SIZES / FORMATS / FORMATE / FORMATOS



● 120x278 (48"x110") RT 6 mm

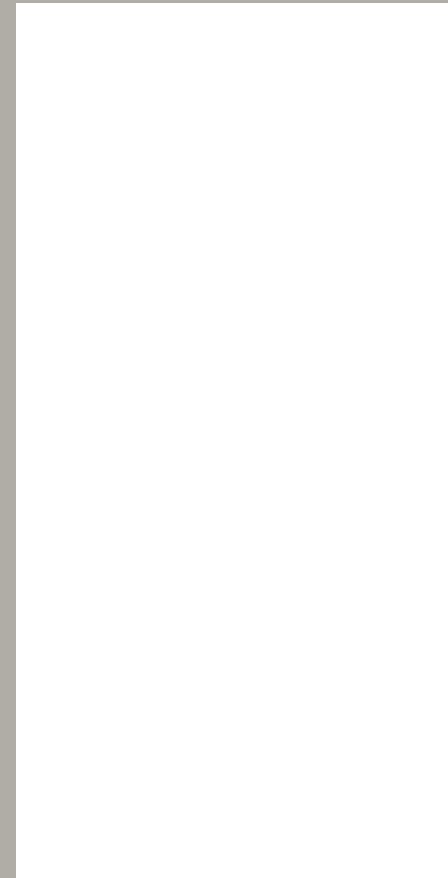

● 120x240 (48"x96") RT 9 mm

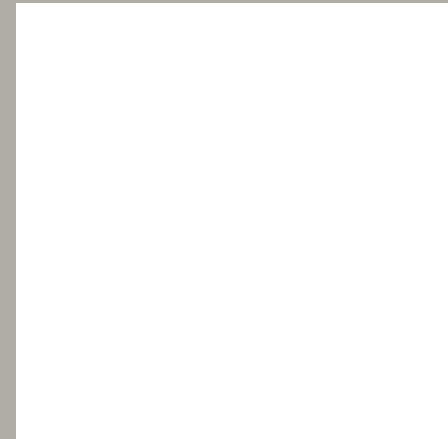

● 120x120 (48"x48") RT 9 mm
▲ 120x120 (48"x48") RT K2 20 mm

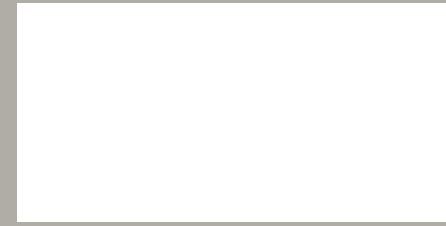

● ▲ 60x120 (24"x48") RT 9 mm



● 30x120 (12"x48") RT 9 mm



● 20x120 (8"x48") RT 9 mm



● 75x75 (30"x30") RT 9 mm

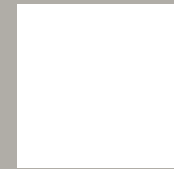

● 45x45 (18"x18") Not RT 9 mm



■ 7,5x30 (3"x12") Not RT 8,5 mm

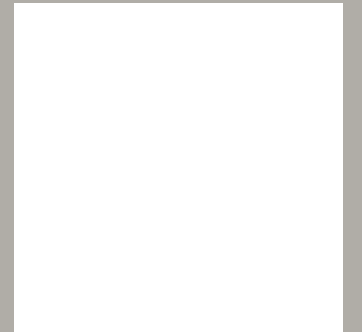

▲ 90x90 (36"x36") RT K2 20 mm

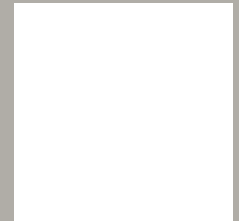

● ▲ 60x60 (24"x24") RT 9 mm
▲ 60x60 (24"x24") RT K2 20 mm
▲ 60x60 (24"x24") RT K3 30 mm



● ▲ 30x60 (12"x24") RT 9 mm



● 14,7x60 (5^{3/4}"x24") RT 9 mm



● 9,7x60 (3^{7/8}"x24") RT 9 mm

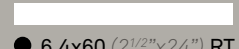

● 6,4x60 (2^{1/2}"x24") RT 9 mm

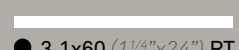

● 3,1x60 (1^{1/4}"x24") RT 9 mm

concrete&design effect | moov

● Natural R9 | ■ Structured R10 | ■ Grip R10 | ▲ Grip R11

3

DECORI/

DECORS / PIECES SPECIALES / FORMTEILE /
PIEZAS ESPECIALES

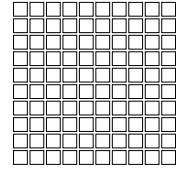

MOSAICO ● 30x30 (12"x12") RT 9 mm
(TESSERE: 2,8x2,8 - 1 1/8"x1 1/8")



MOOV IVORY



MOOV BEIGE



MOOV MOKA



MOOV ANTHRACITE



MOOV GREY

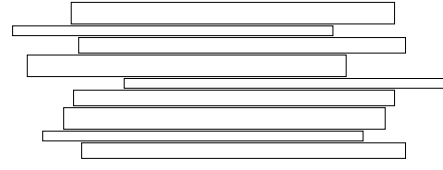

STRIPS ● 30x60 (12"x24") RT 9 mm



MOOV IVORY



MOOV BEIGE



MOOV MOKA



MOOV ANTHRACITE



MOOV GREY



LISTELLO UP ● 9,7x60 (3 7/8"x24") RT 9 mm

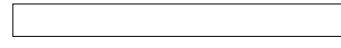

LISTELLO UP ● 6,4x60 (2 1/2"x24") RT 9 mm



MOOV IVORY



MOOV BEIGE



MOOV BEIGE



MOOV MOKA



MOOV MOKA



MOOV ANTHRACITE



MOOV ANTHRACITE



MOOV GREY



MOOV GREY



MOOV GREY

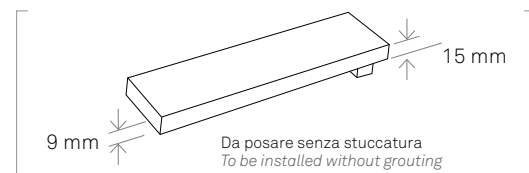

BRIK ■ 7,5x30 (3"x12") Not RT 8,5 mm



BRIK MOOV IVORY



BRIK MOOV MOKA

8

PEZZI SPECIALI/

TRIMS / PIECES SPECIALES / FORMTEILE /
PIEZAS ESPECIALES

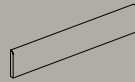

BATTISCOPA

BULLNOSE / PLINTHE / SOCKEL / RODAPIÉ

● 4,6x120 (1^{13/16}"x48") RT 9 mm

● 7,2x75 (2.8"x30") RT 9 mm

● 7,2x60 (2.8"x24") RT 9 mm

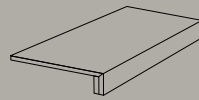

SCALINO CON PROFILO INCOLLATO

GLUED STEP TREAD / NEZ DE MARCHÉ COLLÉ /
GEKLEBTE STUFENPLATTE / PELDAÑO CON PERFIL PEGADO

● 33x60 (13"x24") RT 9 mm

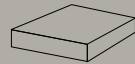

SCALINO ANGOLARE CON PROFILO INCOLLATO

GLUED CORNER STEP TREAD / CARREAU DE MARCHÉ COLLÉ
PIÈCE ANGULAIRE / GEKLEBTE STUFENPLATTE ECKSTÜCK /
PELDAÑO ESQUINA CON PERFIL PEGADO

● 33x33 (13"x13") RT 9 mm

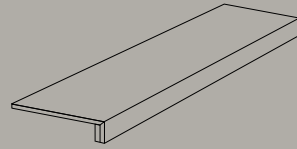

SCALINO CON PROFILO INCOLLATO

GLUED STEP TREAD / NEZ DE MARCHÉ COLLÉ /
GEKLEBTE STUFENPLATTE / PELDAÑO CON PERFIL PEGADO

● 33x120 (13"x48") RT 9 mm

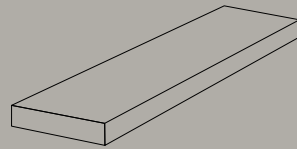

SCALINO ANGOLARE CON PROFILO INCOLLATO

GLUED CORNER STEP TREAD / CARREAU DE MARCHÉ COLLÉ
PIÈCE ANGULAIRE / GEKLEBTE STUFENPLATTE ECKSTÜCK /
PELDAÑO ESQUINA CON PERFIL PEGADO

● 33x120 (13"x48") RT 9 mm

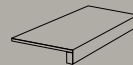

TERMINALE L INCOLLATO

GLUED L TERMINAL / TERMINALE ELLE COLLÉ /
L STÜCK FLIESE GEKLEBT / REMATE EN FORMA DE L PEGADO

● 30x15x4 (12"x6"x1") RT 9 mm

10

PEZZI SPECIALI K₂/

TRIMS K₂ / PIECES SPECIALES K₂ / FORMTEILE K₂ /
PIEZAS ESPECIALES K₂

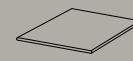

ANGOLARE BORDO CON TORO

CORNER STEP TREAD / NEZ DE MARCHÉ ANGULAIRE /
STUFENPLATTE ECKSTÜCK / ANGULAR CANTO ROMO

▲ 30x30 (12"x12") RT 20 mm

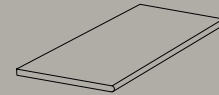

GRADINO BORDO CON TORO

ROUNDED STEP TREAD / NEZ DE MARCHÉ ARRONDI /
GERUNDET STUFENPLATTE / PELDAÑO CANTO ROMO

▲ 30x60 (12"x24") RT 20 mm

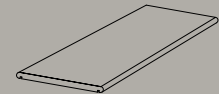

TOP

TOP STEP TREAD / NEZ DE MARCHÉ HAUT /
STUFENPLATTE TOP / TOP CANTO ROMO

▲ 30x60 (12"x24") RT 20 mm

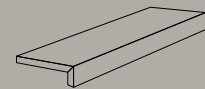

TERMINALE L INCOLLATO

GLUED "L" TERMINAL / TERMINAL "L" COLLÉ /
"L" STÜCK FLIESE GEKLEBT / TERMINAL "L" (PEGADO)

▲ 60x20x5 (24"x8"x2") RT 20 mm

▲ 33x60x5 (13"x24"x2") RT 20 mm

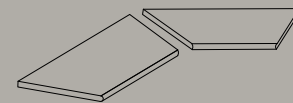

GRADINO ANGOLO INTERNO BORDO CON TORO

INT. CORNER STEP TREAD / ANGLE INT. NEZ DE MARCHÉ /
INNENECKTRITTSTUFE / ANG. INT. CANTO ROMO

▲ 30x60 (12"x24") RT 20 mm

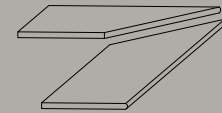

GRADINO ANGOLO ESTERNO BORDO CON TORO

EXT. CORNER STEP TREAD / ANGLE EXT. NEZ DE MARCHÉ /
AUSSENECKTRITTSTUFE / ANG. EXT. CANTO ROMO

▲ 30x60 (12"x24") RT 20 mm

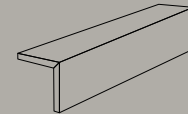

CORDOLO L INCOLLATO

GLUED "L" TERMINAL / TERMINAL "L" COLLÉ /
"L" STÜCK FLIESE GEKLEBT / CANTONERA "L" (PEGADA)

▲ 60x20x15 (24"x8"x6") RT 20 mm

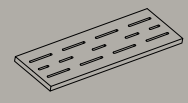

GRIGLIA

GRID / GRIL / GRILL / REJILLA

▲ 15x60 (6"x24") RT 20 mm

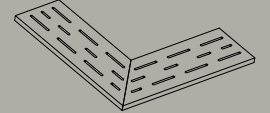

ANGOLARE GRIGLIA

GRID / GRIL / GRILL / ANGULAR REJILLA

▲ 15x60 (6"x24") RT 20 mm

FORMATI

FORMATS / FORMATS / FORMATE / FORMATOS

	120x278 (119,5x278)* 48"x110"	120x240 (119,5x239)* 48"x96"	120x120 (119,5x119,5)* 48"x48"	60x120 24"x48"	30x120 12"x48"	20x120 8"x48"	75x75 30"x30"	60x60 24"x24"	30x60 12"x24"	14,7x60 5 ^{3/4} "x24"	9,7x60 3 ^{7/8} "x24"	6,4x60 3 ^{1/2} "x24"	3,1x60 1 ^{1/4} "x24"	45x45 18"x18"	7,5x30 3"x12"	120x120 (119,5x119,5)* 48"x48"	90x90 36"x36"	60x60 24"x24"	60x60 24"x24"
working size	1194x2778	1194x2390	1194x1194	596x1195	297x1195	197x1195	748x748	596x596	297x596	147x596	97x596	64x596	31x596			1194x1194	895x895	596x596	596x596
	RT	RT	RT	RT	RT	RT	RT	RT	RT	RT	RT	RT	RT	Not RT	Not RT	RT	RT	RT	RT
	6 mm	9 mm	9 mm	9 mm	9 mm	9 mm	9,5 mm	9 mm	9 mm	9 mm	9 mm	9 mm	9 mm	9 mm	8,5 mm	K2 20 mm	K2 20 mm	K2 20 mm	K3 30 mm
MOOV GREY	●	●	●■	●■▲	●	●	●	●■▲	●■▲	●	●	●	●	●		▲	▲	▲	▲
MOOV ANTHRACITE		●	●■	●■▲	●	●	●	●■▲	●■▲	●	●	●	●	●		▲	▲	▲	
MOOV MOKA		●	●■	●■▲	●	●	●	●■▲	●■▲	●	●	●	●	●	■	▲	▲	▲	▲
MOOV BEIGE		●	●■	●■▲	●	●	●	●■▲	●■▲	●	●	●	●	●			▲	▲	
MOOV IVORY	●	●	●■	●■▲	●	●	●	●■▲	●■▲	●	●	●	●	●	■				

*Formato nominale / Nominal size / Format nominal / Nennformat / Formato nominal

● Natural R9 | ■ Structured R10 | ■ Grip R10 | ▲ Grip R11

cementine

3

COLORI/
COLOURS
COULEURS
FARBE
COLORES

1

FORMATI/
SIZES
FORMATS
FORMATE
FORMATOS

1

SUPERFICI/
FINISHES
FINITIONS
OBERFLÄCHEN
ACABADOS

1

SPESSORI/
THICKNESS
ÉPAISSEUR
STÄRKE
ESPEJOR





CEMENTINE COLD
30x30 (12"x12")



CEMENTINE WARM
30x30 (12"x12")

3

COLORI/

COLOURS / COULEURS / FARBE / COLORES

CEMENTINE WARM



CEMENTINE COLD



CEMENTINE COLOR



30 cm

30 cm

Ogni colore del progetto cementine prevede 16 tipologie di grafiche differenti. L'assortimento delle facce all'interno della scatola è puramente casuale / Each color of the cementine project comes with 16 different types of graphics. The assortment of the graphics in the box is purely random / Chaque couleur du projet cementine compte 16 différents graphismes. L'assortiment de graphismes de chaque boîte est complètement aléatoire / Jede Farbe des Projekts Cementine gliedert sich in 16 verschiedene Muster auf. Die Zusammenstellung der verschiedenen Muster in einem Karton ist völlig willkürlich / Cada color de la colección cementine ofrece 16 tipos de diseños gráficos diferentes. La serie de figuras que incluye la caja es aleatoria

1

FORMATI/

SIZES / FORMATS / FORMATE / FORMATOS



● 30x30 (12"x12") RT 9 mm

FORMATI

FORMATS / FORMATS / FORMATE / FORMATOS

	30x30 12"x12"
working size	297x297
	RT
	9 mm
CEMENTINE WARM	●
CEMENTINE COLD	●
CEMENTINE COLOR	●

● Natural R9

elements design

7

COLORI/
COLOURS
COULEURS
FARBE
COLORES

9

FORMATI/
SIZES
FORMATS
FORMATE
FORMATOS

5

SUPERFICI/
FINISHES
FINITIONS
OBERFLÄCHEN
ACABADOS

3

SPESSORI/
THICKNESS
ÉPAISSEUR
STÄRKE
ESPESOR



ELEMENTS DESIGN SILVER
60x120 (24"x48") - 30x60 (12"x24")

ELEMENTS LUX PORT LAURENT
20x120 (8"x48")





ELEMENTS DESIGN BLACK
120x120 (48"x48")
E. LUX CALACATTA
120x240 (48"x96")

ELEMENTS DESIGN TAUPE
120x120 (48"x48") - MOSAICO ROMBI COLD 30,5x35,2 (12^{1/16}"x13^{7/8}")

7

COLORI/
COLOURS / COULEURS / FARBE / COLORES

E. DESIGN IVORY V1



E. DESIGN BEIGE V1



E. DESIGN BLACK V1

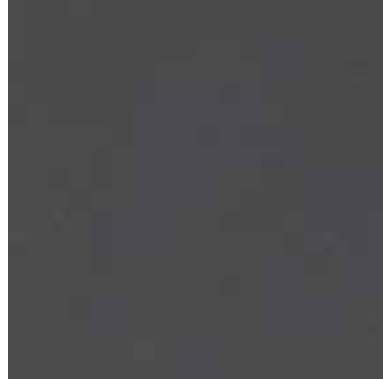

LEED
COMPLIANT

E. DESIGN TAUPE V1



E. DESIGN WHITE V1

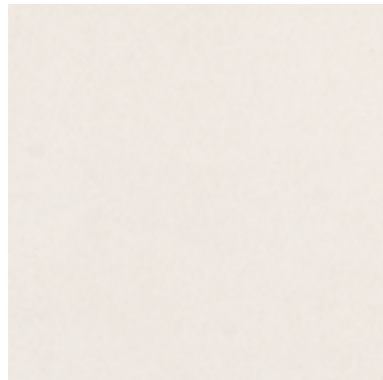

E. DESIGN SILVER V1



E. DESIGN GREY V1



LEED
COMPLIANT

9

FORMATI/
SIZES / FORMATS / FORMATE / FORMATOS



● 120x278 (48"x110") RT 6 mm



● 120x120 (48"x48") RT 9 mm

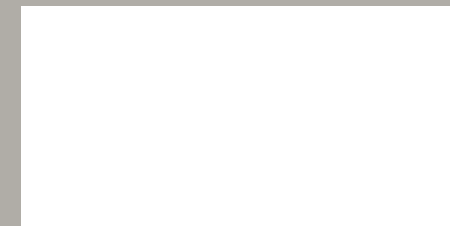

●■◆ 60x120 (24"x48") RT 9 mm
▲ 60x120 (24"x48") RT 20 mm



● 20x120 (8"x48") RT 9 mm

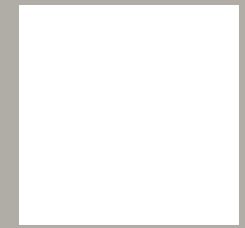

●■◆ 60x60 (24"x24") RT 9 mm



●■ 30x60 (12"x24") RT 9 mm



● 25x21,6 (10"x8^{5/8}) Not RT 9 mm

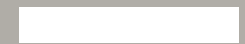

● 9,7x60 (3^{7/8}"x24") RT 9 mm

● Natural | ● Natural R9 | ■ Structured R10 | ◆ Lappato | ▲ Structured R11

3D

50x110 (20"x44") RT 10 mm



ELEMENTS DESIGN BEIGE 3D



ELEMENTS DESIGN WHITE 3D



ELEMENTS DESIGN GREY 3D

4

DECORI/

DECORS / PIECES SPECIALES / FORMTEILE /
PIEZAS ESPECIALES

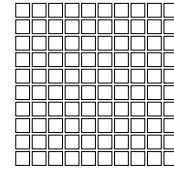

MOSAICO ● 30x30 (12"x12") RT 9 mm
(TESSERE: 2,8x2,8 - 1^{1/8}"x1^{1/8}")



IVORY



BEIGE

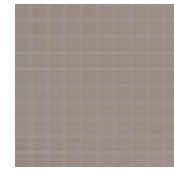

TAUPE



WHITE



SILVER



GREY



BLACK

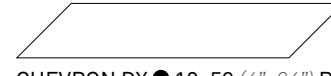

CHEVRON DX ● 10x59 (4"x24") RT 9 mm



CHEVRON SX ● 10x59 (4"x24") RT 9 mm



IVORY



BEIGE



TAUPE



WHITE



SILVER



GREY



BLACK

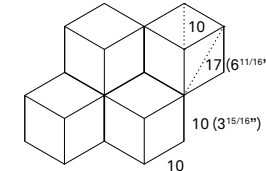

MOSAICO ROMBI
● 30,5x35,2 (12^{1/16}"x13^{7/8}") RT 9 mm



COLD



WARM

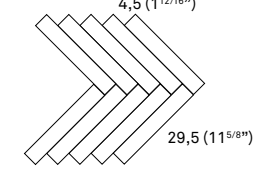

MOSAICO HERRINGBONE
● 34,5x42 (13^{9/16}"x16^{9/16}") RT 9 mm



IVORY



BEIGE



TAUPE



WHITE



SILVER



GREY



BLACK

GLOSSY

★ 7,5x30 (3"x12") Not RT 8,5 mm



ELEMENTS DESIGN IVORY GLOSSY



ELEMENTS DESIGN BEIGE GLOSSY



ELEMENTS DESIGN TAUPE GLOSSY



ELEMENTS DESIGN WHITE GLOSSY



ELEMENTS DESIGN SILVER GLOSSY



ELEMENTS DESIGN GREY GLOSSY



ELEMENTS DESIGN BLACK GLOSSY

5 PEZZI SPECIALI/

TRIMS / PIECES SPECIALES / FORMTEILE /
PIEZAS ESPECIALES



BATTISCOPA
BULLNOSE / PLINTHE / SOCKEL / RODAPIÉ
● 7,2x60 (2,8"x24") RT 9mm

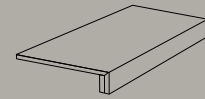

SCALINO CON PROFILO INCOLLATO
GLUED STEP TREAD / NEZ DE MARCHE COLLÉ /
GEKLEBTE STUFENPLATTE / PELDAÑO CON PERFIL PEGADO
●■ 33x60 (13"x24") RT 9mm



SCALINO ANGOLARE CON PROFILO INCOLLATO
GLUED CORNER STEP TREAD / CARREAU DE MARCHE COLLÉ PIÈCE
ANGULAIRE / GEKLEBTE STUFENPLATTE ECKSTÜCK / PELDAÑO
ESQUINA CON PERFIL PEGADO
●■ 33x33 (13"x13") RT 9mm

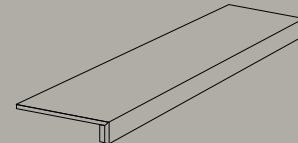

SCALINO CON PROFILO INCOLLATO
GLUED STEP TREAD / NEZ DE MARCHE COLLÉ /
GEKLEBTE STUFENPLATTE / PELDAÑO CON PERFIL PEGADO
●■ 33x120 (13"x48") RT 9 mm

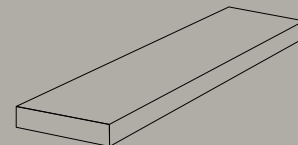

SCALINO ANGOLARE CON PROFILO INCOLLATO
GLUED CORNER STEP TREAD / CARREAU DE MARCHE COLLÉ
PIÈCE ANGULAIRE / GEKLEBTE STUFENPLATTE ECKSTÜCK /
PELDAÑO ESQUINA CON PERFIL PEGADO
●■ 33x120 (13"x48") RT 9 mm

9 PEZZI SPECIALI K₂/

TRIMS K₂ / PIECES SPECIALES K₂ / FORMTEILE K₂ /
PIEZAS ESPECIALES K₂



GRADINO BORDO CON TORO
ROUNDED STEP TREAD / NEZ DE MARCHE
ARRONDI / GERUNDET STUFENPLATTE /
PELDAÑO CANTO ROMO
▲ 30x60 (12"x24") RT 20 mm
▲ 60x120 (24"x48") RT 20 mm

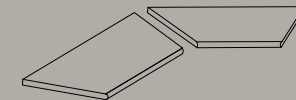

GRADINO ANGOLO INTERNO BORDO CON TORO
INT. CORNER STEP TREAD / ANGLE INT. NEZ DE MARCHE /
INNENECKTRITTSTUFE / ANG. INT. CANTO ROMO
▲ 30x60 (12"x24") RT 20 mm
▲ 60x120 (24"x48") RT 20 mm



GRADINO ANGOLO ESTERNO BORDO CON TORO
EXT. CORNER STEP TREAD / ANGLE EXT. NEZ DE MARCHE /
AUSSENECKTRITTSTUFE / ANG. EXT. CANTO ROMO
▲ 30x60 (12"x24") RT 20 mm
▲ 60x120 (24"x48") RT 20 mm

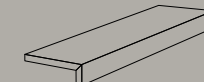

TERMINALE L
GLUED "L" TERMINAL / TERMINAL "L" COLLÉ /
"L" STÜCK FLIESE GEKLEBT / TERMINAL "L"
(PEGADO)
▲ 120x45x15 (48"x18"x6") RT 20 mm

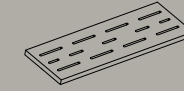

GRIGLIA
GRID / GRIL / GRILL / REJILLA
▲ 15x60 (6"x24") RT 20 mm

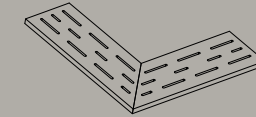

ANGOLARE GRIGLIA
GRID / GRIL / GRILL / ANGULAR REJILLA
▲ 15x60 (6"x24") RT 20 mm

FORMATI

FORMATS / FORMATS / FORMATE / FORMATOS

	120x278 (119,5x278)*	120x120 (119,5x119,5)*	60x120 24"x48"	20x120 8"x48"	60x60 24"x24"	30x60 12"x24"	9,7x60 3 ⁷ / ₈ "x24"	60x120 24"x48"	50x110 20"x44" 3D	25x21,6 10"x8 ⁵ / ₈ " esagona	7,5x30 3"x12"
working size	1194x2778	1194x1194	596x1195	197x1195	596x596	297x596	97x596	596x1195	500x1100		
	RT	RT	RT	RT	RT	RT	RT	RT	RT	Not RT	Not RT
	6 mm	9 mm	9 mm	9 mm	9 mm	9 mm	9 mm	K2 20 mm	10 mm	9 mm	8,5 mm
E.DESIGN IVORY		●	●■	●	●■	●■	●			●	★
E.DESIGN BEIGE	●	●	●■◆	●	●■◆	●■	●	▲	■	●	★
E.DESIGN TAUPE		●	●■	●	●■	●■	●			●	★
E.DESIGN WHITE	●	●	●■◆	●	●■◆	●■	●	▲	■	●	★
E.DESIGN SILVER		●	●■	●	●■	●■	●			●	★
E.DESIGN GREY	●	●	●■◆	●	●■◆	●■	●	▲	■	●	★
E.DESIGN BLACK		●	●■	●	●■	●■	●			●	★

*Formato nominale / Nominal size / Format nominal /
Nennformat / Formato nominal

● Natural | ● Natural R9 | ■ Structured R10 | ▲ Structured R11
★ Glossy | ■ 3D | ◆ Lappato



wood

EFFECT

260 / Beat

268 / Evoke

276 / Soul

beat

5

COLORI/
COLOURS
COULEURS
FARBE
COLORES

4

FORMATI/
SIZES
FORMATS
FORMATE
FORMATOS

3

SUPERFICI/
FINISHES
FINITIONS
OBERFLÄCHEN
ACABADOS

2

SPESSORI/
THICKNESS
ÉPAISSEUR
STÄRKE
ESPEJOR





BEAT TAUPE
20x120 (8"x48")



BEAT GREY
20x120 (8"x48") - DECORO IDRO BEAT CELL 70x80 (29^{9/16}"x31^{1/2}")

wood effect | beat

5

COLORI/
COLOURS / COULEURS / FARBE / COLORES

BEAT BROWN V2



BEAT IVORY V2



BEAT GREY V2



BEAT TAUPE V2



LEED
COMPLIANT

BEAT WALNUT V2



4

FORMATI/
SIZES / FORMATS / FORMATE / FORMATOS



● 30x240 (12"x96") RT 9 mm



▲ 40x120 (16"x48") RT K2 20 mm



● 30x120 (12"x48") RT 9 mm



● ■ 20x120 (8"x48") RT 9 mm

● Natural R9 | ■ Grip R10 | ▲ Structured R11

3

DECORI/

DECORS / PIECES SPECIALES / FORMTEILE /
PIEZAS ESPECIALES

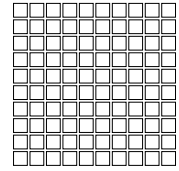

MOSAICO ● 30x30 (12"x12") RT 9 mm
(TESSERE: 2,8x2,8 - 11/6"x11/6")



BEAT BROWN



BEAT IVORY



BEAT GREY



BEAT TAUPE



BEAT WALNUT

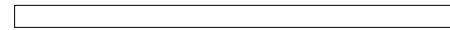

LISTELLO ● 6x120 (2³/₈"x48") RT 9 mm

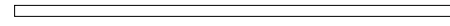

LISTELLO ● 3x120 (1³/₁₆"x48") RT 9 mm



BEAT BROWN



BEAT BROWN



BEAT IVORY



BEAT IVORY



BEAT GREY



BEAT GREY



BEAT TAUPE



BEAT TAUPE



BEAT WALNUT



BEAT WALNUT

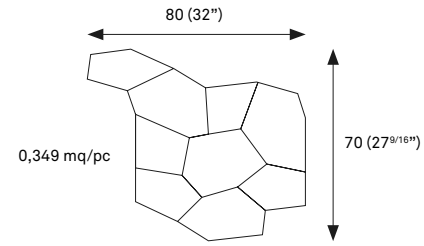

DECORO IDRO BEAT CELL
● 70x80 (27⁹/₁₆"x32") RT 9 mm



BEAT BROWN



BEAT IVORY



BEAT GREY



BEAT TAUPE



BEAT WALNUT

3

PEZZI SPECIALI/

TRIMS / PIECES SPECIALES / FORMTEILE /
PIEZAS ESPECIALES



BATTISCOPA
BULLNOSE / PLINTHE / SOCKEL / RODAPIÉ
● 6,2x60 (2.4"x24") RT 9 mm

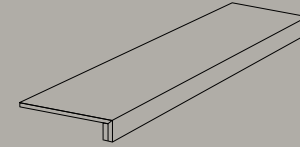

SCALINO CON PROFILO INCOLLATO
GLUED STEP TREAD / NEZ DE MARCHE COLLÉ /
GEKLEBTE STUFENPLATTE / PELDAÑO CON PERFIL PEGADO
● 30x120 (12"x48") RT 9 mm

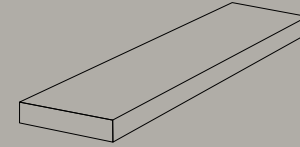

ANGOLARE INCOLLATO
GLUED CORNER STEP TREAD / CARREAU DE MARCHE COLLÉ
PIÈCE ANGULAIRE / GEKLEBTE STUFENPLATTE ECKSTÜCK /
PELDAÑO ESQUINA CON PERFIL PEGADO
● 30x120 (12"x48") RT 9 mm

1

PEZZI SPECIALI K₂/

TRIMS K₂ / PIECES SPECIALES K₂ /
FORMTEILE K₂ / PIEZAS ESPECIALES K₂

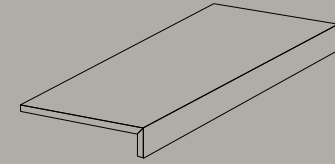

TERMINALE L INCOLLATO
GLUED L TERMINAL / TERMINALE ELLE COLLÉ / L STÜCK
FLIESE GEKLEBT / REMATE EN FORMA DE L PEGADO
▲ 120x40x10 (48"x18"x4") RT 20 mm

FORMATI

SIZES / FORMATS / FORMATE / FORMATOS

	30x240 (30x239)* 12"x96"	30x120 12"x48"	20x120 8"x48"	40x120 16"x48"
working size	297x2390 RT 9 mm	297x1195 RT 9 mm	197x1195 RT 9 mm	397x1195 RT K ₂ 20 mm
BEAT BROWN		●	● ■	
BEAT IVORY		●	● ■	
BEAT GREY	●	●	● ■	▲
BEAT TAUPE		●	● ■	
BEAT WALNUT	●	●	● ■	▲

*Formato nominale / Nominal size / Format nominal / Nennformat / Formato nominal

● Natural R9 | ■ Grip R10 | ▲ Structured R11

evoke

5

COLORI/
COLOURS
COULEURS
FARBE
COLORES

5

FORMATI/
SIZES
FORMATS
FORMATE
FORMATOS

2

SUPERFICI/
FINISHES
FINITIONS
OBERFLÄCHEN
ACABADOS

2

SPESSORI/
THICKNESS
ÉPAISSEUR
STÄRKE
ESPESOR





EVOKE IVORY
20x120 (8"x48") - 30x120 (12"x48")

EVOKE BROWN
30x120 (12"x48") - 20x120 (8"x48") -
15x20 (6"x48") - 30x120 (12"x48") K2 20mm

5

COLORI/
COLOURS / COULEURS / FARBE / COLORES

EVOKE IVORY **V2**



EVOKE BEIGE **V2**



EVOKE SAND **V2**



EVOKE BROWN **V2**

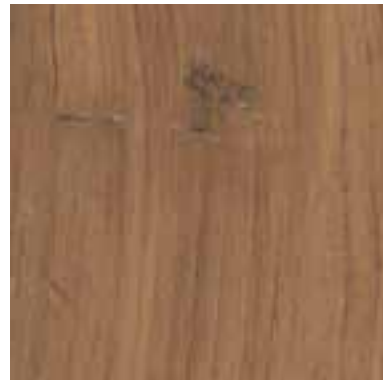

EVOKE MOKA **V2**



5

FORMATI/
SIZES / FORMATS / FORMATE / FORMATOS



- 30x120 (12"x48") RT 9 mm
- ▲ 30x120 (12"x48") RT **K2** 20 mm



- ▲ 20x120 (8"x48") RT 9 mm



- 15x120 (6"x48") RT 9 mm

- 30x240 (12"x96") RT 9 mm

- Natural R9 | ▲ Structured R11

1

DECORO/

DECORS / PIECES SPECIALES / FORMTEILE /
PIEZAS ESPECIALES

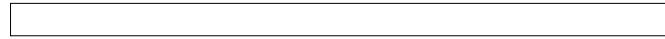

LISTELLO ● 6x120 (2 1/2"x48") RT 9 mm

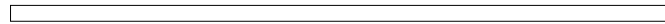

LISTELLO ● 3x120 (1 1/4"x48") RT 9 mm



EVOKE IVORY



EVOKE IVORY



EVOKE BEIGE



EVOKE BEIGE



EVOKE SAND



EVOKE SAND



EVOKE BROWN



EVOKE BROWN



EVOKE MOKA



EVOKE MOKA

3

PEZZI SPECIALI/

TRIMS / PIECES SPECIALES / FORMTEILE /
PIEZAS ESPECIALES



BATTISCOPA

BULLNOSE / PLINTHE / SOCKEL / RODAPIÉ

● 7,2x60 (2,8"x24") RT 9 mm

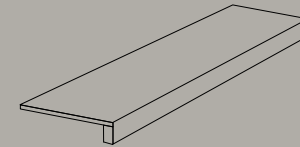

SCALINO CON PROFILO INCOLLATO

GLUED STEP TREAD / NEZ DE MARCHE COLLÉ /
GEKLEBTE STUFENPLATTE / PELDAÑO CON PERFIL PEGADO

● 30x120 (12"x48") RT 9 mm

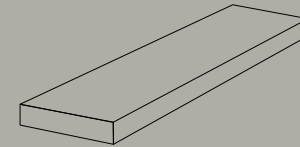

ANGOLARE INCOLLATO

GLUED CORNER STEP TREAD / CARREAU DE MARCHE COLLÉ
PIÈCE ANGULAIRE / GEKLEBTE STUFENPLATTE ECKSTÜCK /
PELDAÑO ESQUINA CON PERFIL PEGADO

● 30x120 (12"x48") RT 9 mm

3

PEZZI SPECIALI K2/

TRIMS K2 / PIECES SPECIALES K2 / FORMTEILE K2 /
PIEZAS ESPECIALES K2

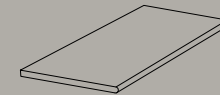

GRADINO BORDO CON TORO

ROUNDED STEP TREAD / NEZ DE MARCHE ARRONDI /
GERUNDET STUFENPLATTE / PELDAÑO CANTO ROMO

▲ 30x120 (12"x48") RT 20 mm

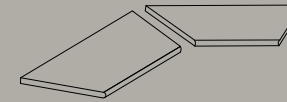

GRADINO ANGOLO INTERNO BORDO CON TORO

INT. CORNER STEP TREAD / ANGLE INT. NEZ DE MARCHE /
INNENECKTRITTSTUFE / ANG. INT. CANTO ROMO

▲ 30x120 (12"x48") RT 20 mm

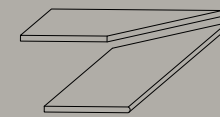

GRADINO ANGOLO ESTERNO BORDO CON TORO

EXT. CORNER STEP TREAD / ANGLE EXT. NEZ DE MARCHE /
AUSSENECKTRITTSTUFE / ANG. EXT. CANTO ROMO

▲ 30x120 (12"x48") RT 20 mm

FORMATI

FORMATS / FORMATS / FORMATE / FORMATOS

	30x240 (30x239)* 12"x96"	30x120 12"x48"	20x120 8"x48"	15x120 6"x48"	30x120 12"x48"
working size	297x2390	297x1195	197x1195	147x1195	297x1195
	RT	RT	RT	RT	RT
	9 mm	9 mm	9 mm	9 mm	K2 20 mm
EVOKE IVORY		●	●▲	●	
EVOKE SAND	●	●	●	●	▲
EVOKE BEIGE		●	●▲	●	
EVOKE BROWN	●	●	●	●	▲
EVOKE MOKA		●	●▲	●	

*Formato nominale / Nominal size / Format nominal / Nennformat / Formato nominal

● Natural R9 | ▲ Structured R11

soul

5

COLORI/
COLOURS
COULEURS
FARBE
COLORES

5

FORMATI/
SIZES
FORMATS
FORMATE
FORMATOS

2

SUPERFICI/
FINISHES
FINITIONS
OBERFLÄCHEN
ACABADOS

2

SPESSORI/
THICKNESS
ÉPAISSEUR
STÄRKE
ESPESOR



5

COLORI/
COLOURS / COULEURS / FARBE / COLORES

SOUL GREY V3



SOUL PEARL V2



SOUL BEIGE V2



SOUL WALNUT V2



SOUL BLEND V4



5

FORMATI/
SIZES / FORMATS / FORMATE / FORMATOS



● 25x150 (10"x60") RT 9 mm



● 12,3x150 (5"x60") RT 9 mm



● 8,1x150 (3^{1/4}"x60") RT 9 mm



▲ 30x120 (12"x48") RT ⇒ K2 20 mm

● 30x240 (12"x96") RT 9 mm

● Natural R9 | ▲ Structured R11



SOUL PEARL
25x150 (10"x60")

1

PEZZI SPECIALI/

TRIMS / PIECES SPECIALES / FORMTEILE /
PIEZAS ESPECIALES



BATTISCOPIA
BULLNOSE / PLINTHE / SOCKEL / RODAPIÉ
● 7,2x75 (2,8"x30") RT 9 mm

3

PEZZI SPECIALI K2/

TRIMS K2 / PIECES SPECIALES K2 / FORMTEILE K2 /
PIEZAS ESPECIALES K2

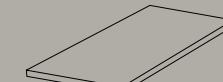

GRADINO BORDO CON TORO
ROUNDED STEP TREAD / NEZ DE MARCHE ARRONDI /
GERUNDET STUFENPLATTE / PELDAÑO CANTO ROMO
▲ 30x120 (12"x48") RT 20 mm



GRADINO ANGOLO INTERNO BORDO CON TORO
INT. CORNER STEP TREAD / ANGLE INT. NEZ DE MARCHE /
INNENECKTRITTSTUFE / ANG. INT. CANTO ROMO
▲ 30x120 (12"x48") RT 20 mm



GRADINO ANGOLO ESTERNO BORDO CON TORO
EXT. CORNER STEP TREAD / ANGLE EXT. NEZ DE MARCHE /
AUSSENECKTRITTSTUFE / ANG. EXT. CANTO ROMO
▲ 30x120 (12"x48") RT 20 mm

FORMATI

FORMATS / FORMATS / FORMATE / FORMATOS

	30x240 (30x239)* 12"x96"	25x150 10"x60"	12,3x150 5"x60"	8,1x150 3 1/4"x60"	30x120 12"x48"
working size	297x2390	248x1498	123x1498	81x1498	297x1195
	RT	RT	RT	RT	RT
	9 mm	9 mm	9 mm	9 mm	K2 20 mm
SOUL PEARL	●	●	●	●	
SOUL BEIGE		●	●	●	
SOUL BLEND		●	●	●	▲
SOUL WALNUT		●	●	●	▲
SOUL GREY	●	●	●	●	▲

*Formato nominale / Nominal size / Format nominal / Nennformat / Formato nominal

● Natural R9 | ▲ Structured R11



colour

EFFECT

284 /K-Color

290 /Granigliati - Linea Tecnica

k-color

21

COLORI/
COLOURS
COULEURS
FARBE
COLORES

1

FORMATI/
SIZES
FORMATS
FORMATE
FORMATOS

2

SUPERFICI/
FINISHES
FINITIONS
OBERFLÄCHEN
ACABADOS

1

SPESSORI/
THICKNESS
ÉPAISSEUR
STÄRKE
ESPEJOR



21

COLORI/
COLOURS / COULEURS / FARBE / COLORES

NIGHT V1 PEI III	GREYNESS V1 PEI III	URBAN V1 URBAN GRIP V1 PEI IV PEI IV	PEARL V1 PEI IV	ECRU V1 PEI IV	MOON V1 PEI III	BROWN V1 PEI III	LILAC V1 PEI IV
WHITE V1 WHITE GRIP V1 PEI IV PEI IV	SKY V1 PEI IV	CRYSTAL V1 CRYSTAL GRIP V1 PEI III PEI IV	MINT V1 MINT GRIP V1 PEI IV PEI IV	ROSE V1 PEI IV	SALMON V1 PEI III	LEMON V1 PEI IV	ORANGE V1 PEI IV
NAVY V1 PEI III	SPRING V1 PEI III	IVORY V1 IVORY GRIP V1 PEI IV PEI IV	CAMEL V1 PEI IV	FIRE V1 PEI IV			

colour effect | k-color



K-COLOR
GREYNESS 20X20 (8"x8")

K-COLOR
PEARL 20X20 (8"x8")

1

FORMATO/

SIZES / FORMATS / FORMATE / FORMATOS

● ■ 20x20 (8"x8") Not RT 7,3 mm

5

PEZZI SPECIALI/

TRIMS / PIECES SPECIALES / FORMTEILE /
PIEZAS ESPECIALES

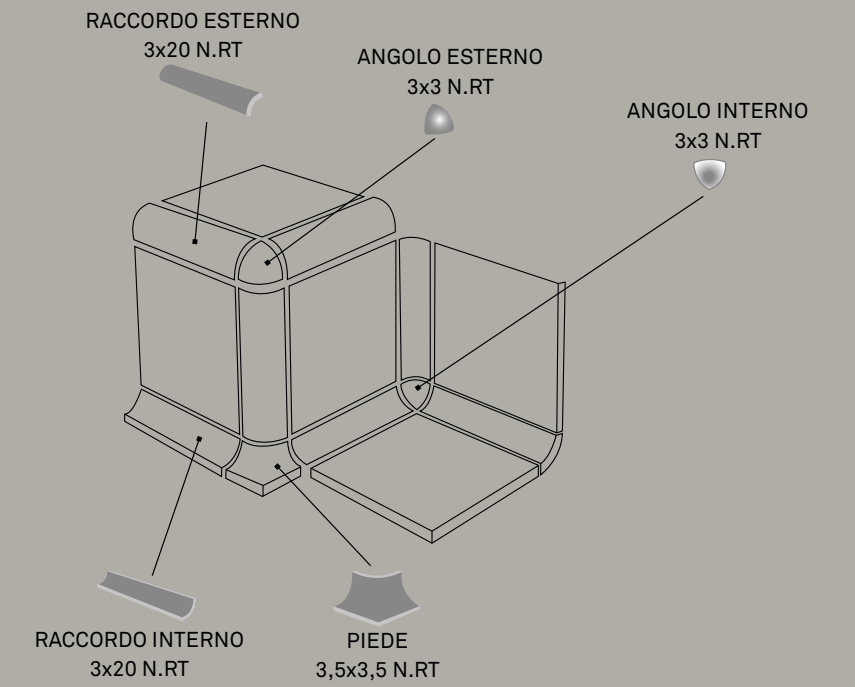

FORMATI

FORMATS / FORMATS / FORMATE / FORMATOS

	20x20 8"x8"
	Not RT 7,3 mm
NIGHT	●
GREYNESS	●
URBAN	● ■
PEARL	●
WHITE	● ■
SKY	●
CRYSTAL	● ■
NAVY	●
MINT	● ■
SPRING	●
IVORY	● ■

	20x20 8"x8"
	Not RT 7,3 mm
CAMEL	●
ECRU	●
MOON	●
BROWN	●
LILIAC	●
ROSE	●
SALMON	●
LEMON	●
ORANGE	●
FIRE	●

● Natural | ■ Grip R10

colour effect | k-color

granigliati linea tecnica

7

COLORI/
COLOURS
COULEURS
FARBE
COLORES

2

FORMATI/
SIZES
FORMATS
FORMATE
FORMATOS

2

SUPERFICI/
FINISHES
FINITIONS
OBERFLÄCHEN
ACABADOS

2

SPESSORI/
THICKNESS
ÉPAISSEUR
STÄRKE
ESPESOR



granigliati

AURORA **v0**



CALEDONIA **v0**



PORFIDO **v0**



PIETRA SERENA **v0**



DIASPRO **v0**



BARDIGLIO **v0**



CARPARO **v0**



linea tecnica

AURORA **v0**



PIETRA SERENA **v0**



BARDIGLIO **v0**



CARPARO **v0**



2

FORMATI/

SIZES / FORMATS / FORMATE / FORMATOS



- + 30x30 (12"x12") Not RT 8,6 mm
- 30x30 (12"x12") Not RT 14 mm

8

PEZZI SPECIALI/

TRIMS / PIECES SPECIALES / FORMTEILE /
PIEZAS ESPECIALES



BATTISCOPA

BULLNOSE / PLINTHE /
SOCKEL / RODAPIÉ

- 10x30 (4"x12") Not RT 8,6 mm

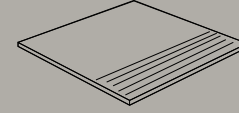

GRADINO

STEP TREAD / NEZ DE MARCHE
STUFENPLATTE / PELDAÑO

- 30x30 (12"x12") Not RT 8,6 mm

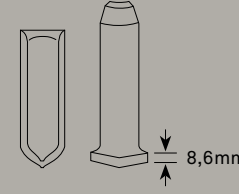
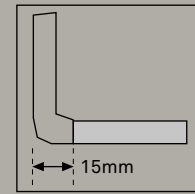

ANGOLI RACCORDO INT./EST.

CORNER INT./EXT / ANGLE INT./EST.
INN/AUSS ECKE / ÁNGULOS INT./EXT.

- 10x3 (4"x1³/₁₆") Not RT 8,6 mm

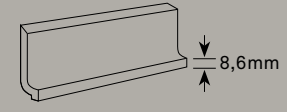

RACCORDO A PAVIMENTO

COVE BASE / PLINTHE À GORGE
HOHLKEHLSOCKEL / UNIÓN DE PISO

- 10x30 (4"x12") Not RT 8,6 mm

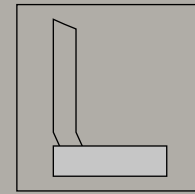

ANGOLI SGUSCIA INT./EST.

CORNER INT./EXT / ANGLE INT./EST.
INN/AUSS ECKE / ÁNGULOS INT./EXT.

- 10x3 (4"x1³/₁₆") Not RT 8,6 mm



BATTISCOPA CON SGUSCIA

COVE BASE / PLINTHE À TALON
AUFSETZSOCKEL / ESCOCIA

- 10x30 (4"x12") Not RT 8,6 mm

FORMATI

FORMATS / FORMATS / FORMATE / FORMATOS

	30x30 12"x12"	30x30 12"x12"
	Not RT	Not RT
	8,6 mm	14,0 mm
AURORA	●+	
BARDIGLIO	●+	
CALEDONIA	●	
PORFIDO	●	
CARPARO	●+	
DIASPRO	●	●
PIETRA SERENA	●+	

● Natural R9 | + R12

● Natural R9 | + R12

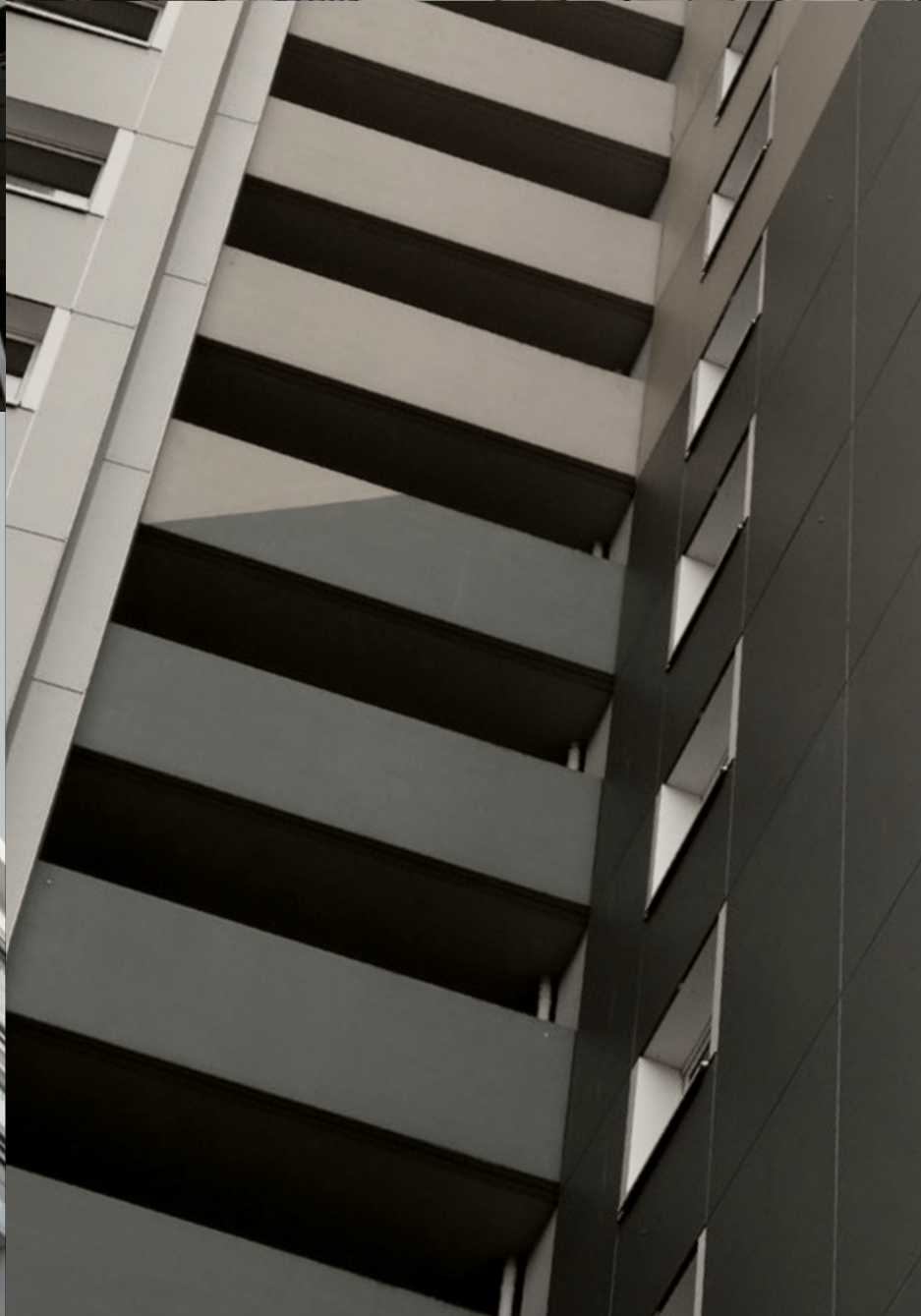

contract

298 / Dunstone

302 / Londale

306 / Swisstone

310 / Extreme

314 / Skywall

318 / Urban

322 / Way

dunstone

STONE EFFECT

3

COLORI/
COLOURS
COULEURS
FARBE
COLORES

3

FORMATI/
SIZES
FORMATS
FORMATE
FORMATOS

1

SUPERFICI/
FINISHES
FINITIONS
OBERFLÄCHEN
ACABADOS

1

SPESSORI/
THICKNESS
ÉPAISSEUR
STÄRKE
ESPESOR



3

COLORI/

COLOURS / COULEURS / FARBE / COLORES

DUNSTONE IVORY



DUNSTONE BEIGE



LEED
COMPLIANT

DUNSTONE GREY



LEED
COMPLIANT

3

FORMATI/

SIZES / FORMATS / FORMATE / FORMATOS

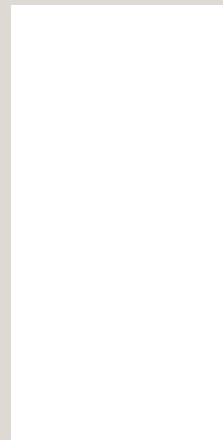

● 60x120 (24"x48") RT 9 mm

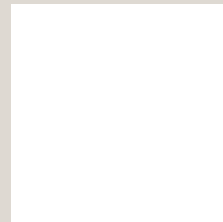

● 60x60 (24"x24") RT 8,5 mm



● 30x60 (12"x24") RT 8,5 mm

5

PEZZI SPECIALI/

TRIMS / PIECES SPECIALES / FORMTEILE /
PIEZAS ESPECIALES



BATTISCOPA

BULLNOSE / PLINTHE / SOCKEL / RODAPIÉ

● 7,2x60 (2.8"x24") RT 8,5 mm

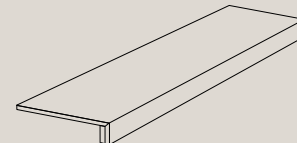

SCALINO INCOLLATO

GLUED STEP TREAD / NEZ DE MARCHE COLLÉ /
GEKLEBTE STUFENPLATTE / PELDAÑO CON PERFIL PEGADO

● 33x120 (13"x48") RT 9 mm

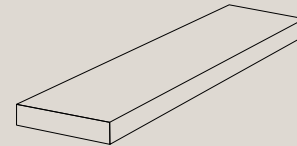

ANGOLARE INCOLLATO

GLUED CORNER STEP TREAD / CARREAU DE MARCHE COLLÉ
PIÈCE ANGULAIRE / GEKLEBTE STUFENPLATTE ECKSTÜCK /
PELDAÑO ESQUINA CON PERFIL PEGADO

● 33x120 (13"x48") RT 9 mm

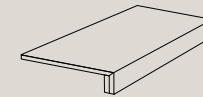

SCALINO INCOLLATO

GLUED STEP TREAD / NEZ DE MARCHE COLLÉ /
GEKLEBTE STUFENPLATTE / PELDAÑO CON PERFIL PEGADO

● 33x60 (13"x24") RT 8,5 mm



ANGOLARE INCOLLATO

GLUED CORNER STEP TREAD / CARREAU DE MARCHE COLLÉ
PIÈCE ANGULAIRE / GEKLEBTE STUFENPLATTE ECKSTÜCK /
PELDAÑO ESQUINA CON PERFIL PEGADO

● 33x33 (13"x13") RT 8,5 mm

FORMATI

FORMATS / FORMATS / FORMATE / FORMATOS

	60x120 24"x48"	60x60 24"x24"	30x60 12"x24"
working size	596x1195	596x596	297x596
	RT	RT	RT
	9 mm	8,5 mm	8,5 mm
DUNSTONE IVORY	●	●	●
DUNSTONE BEIGE	●	●	●
DUNSTONE GREY	●	●	●

● Natural R9

● Natural R9

londale

CONCRETE EFFECT

3

COLORI/
COLOURS
COULEURS
FARBE
COLORES

3

FORMATI/
SIZES
FORMATS
FORMATE
FORMATOS

1

SUPERFICI/
FINISHES
FINITIONS
OBERFLÄCHEN
ACABADOS

1

SPESSORI/
THICKNESS
ÉPAISSEUR
STÄRKE
ESPESOR



3

COLORI/

COLOURS / COULEURS / FARBE / COLORES

LONDALE SILVER



LONDALE BEIGE



LONDALE GREY



3

FORMATI/

SIZES / FORMATS / FORMATE / FORMATOS

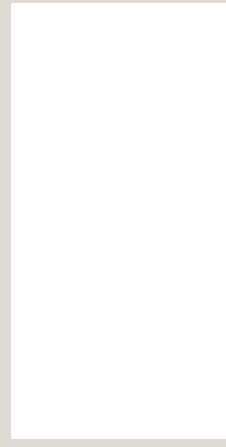

● 60x120 (24"x48") RT 9 mm

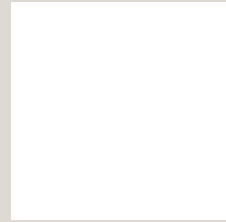

● 60x60 (24"x24") RT 8,5 mm

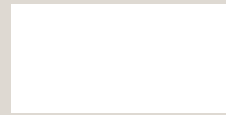

● 30x60 (12"x24") RT 8,5 mm

5

PEZZI SPECIALI/

TRIMS / PIECES SPECIALES / FORMTEILE / PIEZAS ESPECIALES



BATTISCOPA

BULLNOSE / PLINTHE / SOCKEL / RODAPIÉ

● 7,2x60 (2.8"x24") RT 8,5 mm

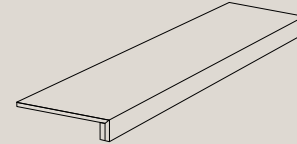

SCALINO INCOLLATO

GLUED STEP TREAD / NEZ DE MARCHE COLLÉ / GEKLEBTE STUFENPLATTE / PELDAÑO CON PERFIL PEGADO

● 33x120 (13"x48") RT 9 mm

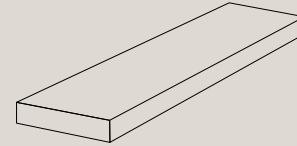

ANGOLARE INCOLLATO

GLUED CORNER STEP TREAD / CARREAU DE MARCHE COLLÉ PIÈCE ANGULAIRE / GEKLEBTE STUFENPLATTE ECKSTÜCK / PELDAÑO ESQUINA CON PERFIL PEGADO

● 33x120 (13"x48") RT 9 mm



SCALINO INCOLLATO

GLUED STEP TREAD / NEZ DE MARCHE COLLÉ / GEKLEBTE STUFENPLATTE / PELDAÑO CON PERFIL PEGADO

● 33x60 (13"x24") RT 8,5 mm



ANGOLARE INCOLLATO

GLUED CORNER STEP TREAD / CARREAU DE MARCHE COLLÉ PIÈCE ANGULAIRE / GEKLEBTE STUFENPLATTE ECKSTÜCK / PELDAÑO ESQUINA CON PERFIL PEGADO

● 33x33 (13"x13") RT 8,5 mm

FORMATI

FORMATS / FORMATS / FORMATE / FORMATOS

	60x120 24"x48"	60x60 24"x24"	30x60 12"x24"
working size	596x1195	596x596	297x596
	RT	RT	RT
	9 mm	8,5 mm	8,5 mm
LONDALE SILVER	●	●	●
LONDALE BEIGE	●	●	●
LONDALE GREY	●	●	●

● Natural R9

● Natural R9

swisstone

STONE EFFECT

3

COLORI/
COLOURS
COULEURS
FARBE
COLORES

4

FORMATI/
SIZES
FORMATS
FORMATE
FORMATOS

2

SUPERFICI/
FINISHES
FINITIONS
OBERFLÄCHEN
ACABADOS

2

SPESSORI/
THICKNESS
ÉPAISSEUR
STÄRKE
ESPESOR



3

COLORI/

COLOURS / COULEURS / FARBE / COLORES

SWISSTONE ANTHRACITE

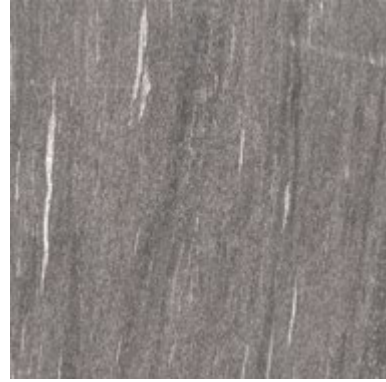

SWISSTONE GREY



SWISSTONE TAUPE



4

FORMATI/

SIZES / FORMATS / FORMATE / FORMATOS



■ 60x120 (24"x48") RT 9 mm

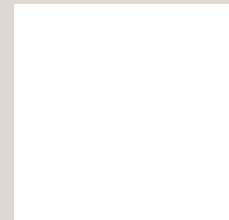

■ 60x60 (24"x24") RT 8,5 mm
▲ 60x60 (24"x24") RT K2 20 mm



■ 30x60 (12"x24") RT 8,5 mm

5

PEZZI SPECIALI/

TRIMS / PIECES SPECIALES / FORMTEILE / PIEZAS ESPECIALES



BATTISCOPIA
BULLNOSE / PLINTHE / SOCKEL / RODAPIÉ
■ 7,2x60 (2.8"x24") RT 8,5 mm

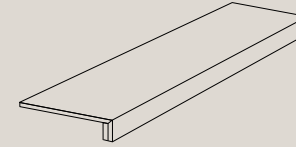

SCALINO INCOLLATO
GLUED STEP TREAD / NEZ DE MARCHE COLLÉ / GEKLEBTE STUFENPLATTE / PELDAÑO CON PERFIL PEGADO
■ 33x120 (13"x48") RT 9 mm

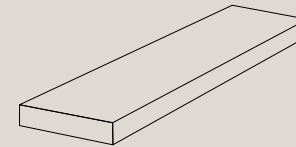

ANGOLARE INCOLLATO
GLUED CORNER STEP TREAD / CARREAU DE MARCHE COLLÉ / PIÈCE ANGULAIRE / GEKLEBTE STUFENPLATTE ECKSTÜCK / PELDAÑO ESQUINA CON PERFIL PEGADO
■ 33x120 (13"x48") RT 9 mm

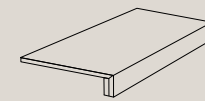

SCALINO INCOLLATO
GLUED STEP TREAD / NEZ DE MARCHE COLLÉ / GEKLEBTE STUFENPLATTE / PELDAÑO CON PERFIL PEGADO
■ 33x60 (13"x24") RT 8,5 mm



ANGOLARE INCOLLATO
GLUED CORNER STEP TREAD / CARREAU DE MARCHE COLLÉ / PIÈCE ANGULAIRE / GEKLEBTE STUFENPLATTE ECKSTÜCK / PELDAÑO ESQUINA CON PERFIL PEGADO
■ 33x33 (13"x13") RT 8,5 mm

FORMATI

FORMATS / FORMATS / FORMATE / FORMATOS

	60x120 24"x48"	60x60 24"x24"	30x60 12"x24"	60x60 24"x24"
working size	596x1195	596x596	297x596	596x596
	RT	RT	RT	RT
	9 mm	8,5 mm	8,5 mm	K2 20 mm
SWISSTONE ANTHRACITE	■	■	■	▲
SWISSTONE GREY	■	■	■	▲
SWISSTONE TAUPE	■	■	■	▲

■ Structured R10 | ▲ Structured R11

■ Structured R10 | ▲ Structured R11

10

PEZZI SPECIALI K2/

TRIMS K2 / PIECES SPECIALES K2 / FORMTEILE K2 / PIEZAS ESPECIALES K2

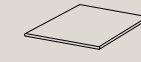

ANGOLARE BORDO CON TORO
CORNER STEP TREAD / NEZ DE MARCHE ANGULAIRE / STUFENPLATTE ECKSTÜCK / ANGULAR CANTO ROMO
▲ 30x30 (12"x12") RT 20 mm



GRADINO BORDO CON TORO
ROUNDED STEP TREAD / NEZ DE MARCHE ARRONDI / GERUNDET STUFENPLATTE / PELDAÑO CANTO ROMO
▲ 30x60 (12"x24") RT 20 mm

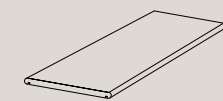

TOP BORDO TORO
TOP STEP TREAD / NEZ DE MARCHE HAUT / STUFENPLATTE TOP / TOP CANTO ROMO
▲ 30x60 (12"x24") RT 20 mm



GRIGLIA
GRID / GRIL / GRILL / REJILLA
▲ 15x60 (6"x24") RT 20 mm

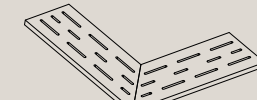

ANGOLARE GRIGLIA
GRID / GRIL / GRILL / ANGULAR REJILLA
▲ 15x60 (6"x24") RT 20 mm

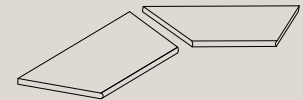

GRADINO ANGOLO INTERNO BORDO CON TORO
INT. CORNER STEP TREAD / ANGLE INT. NEZ DE MARCHE / INNENECKTRITTSTUFE / ANG. INT. CANTO ROMO
▲ 30x60 (12"x24") RT 20 mm



GRADINO ANGOLO ESTERNO BORDO CON TORO
EXT. CORNER STEP TREAD / ANGLE EXT. NEZ DE MARCHE / AUSSENECKTRITTSTUFE / ANG. EXT. CANTO ROMO
▲ 30x60 (12"x24") RT 20 mm

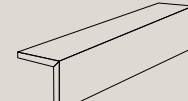

CORDOLO L
GLUED "L" TERMINAL / TERMINAL "L" COLLÉ / "L" STÜCK FLIESE GEKLEBT / CANTONERA "L" (PEGADA)
▲ 60x20x15 (24"x8" x6") RT 20 mm



TERMINALE L
GLUED "L" TERMINAL / TERMINAL "L" COLLÉ / "L" STÜCK FLIESE GEKLEBT / TERMINAL "L" (PEGADO)
▲ 60x20x5 (24"x8" x2") RT 20 mm

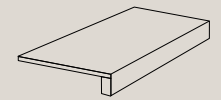

SCALINO INCOLLATO
STEP TREAD / NEZ DE MARCHE / STUFENPLATTE / PELDAÑO (PEGADO)
▲ 33x60x5 (13"x24"x2") RT 20 mm

extreme

STONE EFFECT

3

COLORI/
COLOURS
COULEURS
FARBE
COLORES

2

FORMATI/
SIZES
FORMATS
FORMATE
FORMATOS

1

SUPERFICI/
FINISHES
FINITIONS
OBERFLÄCHEN
ACABADOS

1

SPESSORI/
THICKNESS
ÉPAISSEUR
STÄRKE
ESPESOR

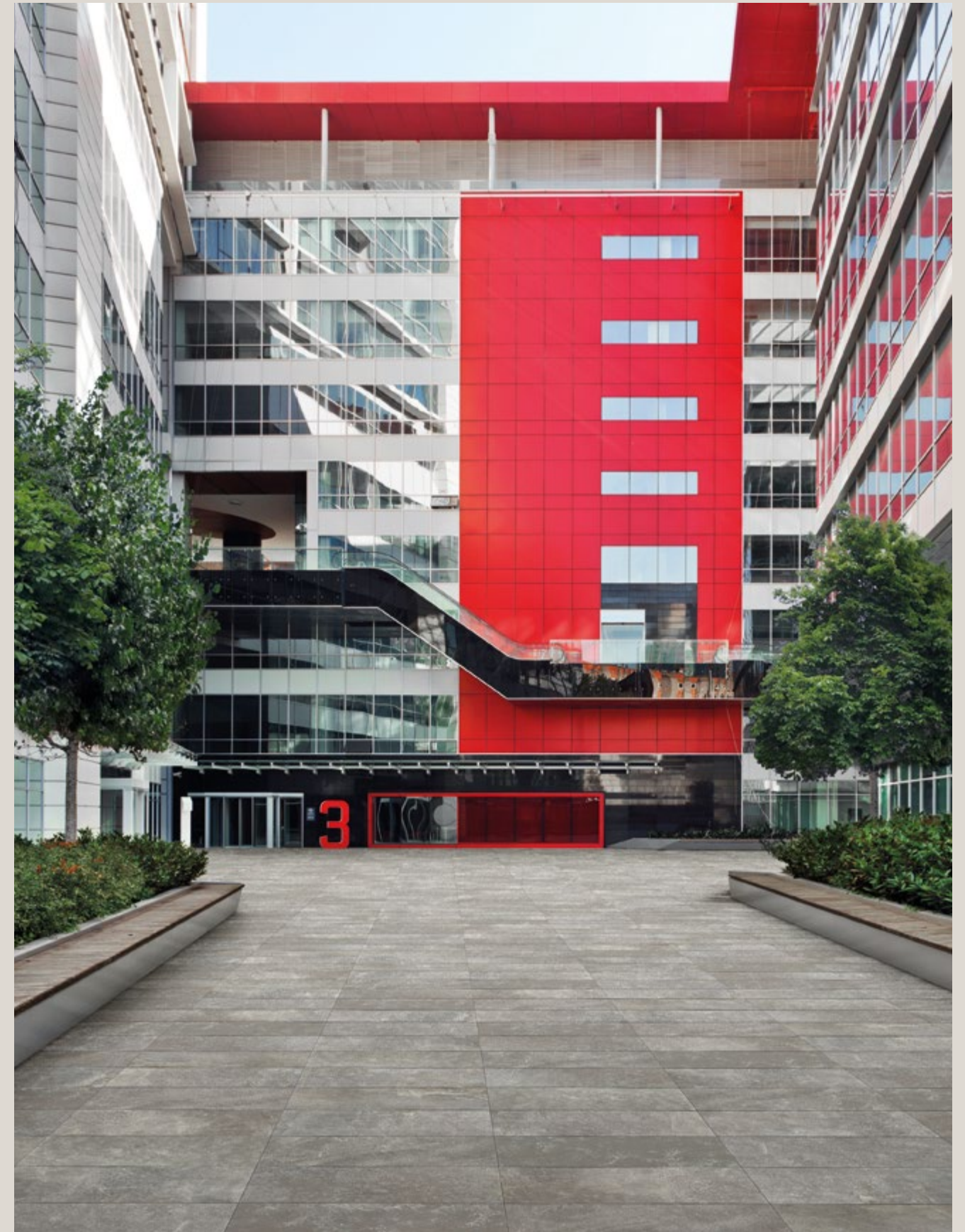

3

COLORI/

COLOURS / COULEURS / FARBE / COLORES

EXTREME BEIGE



EXTREME GREY



EXTREME ANTHRACITE

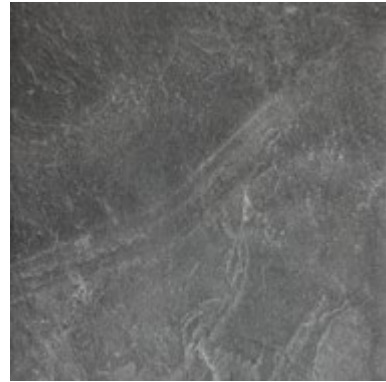

2

FORMATI/

SIZES / FORMATS / FORMATE / FORMATOS

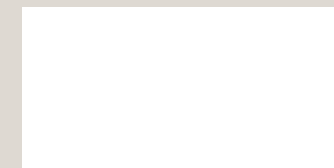

▲ 45x90 (18"x36") RT ➔ K2 20 mm

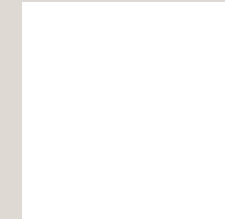

▲ 60x60 (24"x24") RT ➔ K2 20 mm

14

PEZZI SPECIALI K₂/

TRIMS K₂ / PIECES SPECIALES K₂ / FORMTEILE K₂ / PIEZAS ESPECIALES K₂



ANGOLARE BORDO CON TORO
CORNER STEP TREAD / NEZ DE MARCHE ANGULAIRE / STUFENPLATTE ECKSTÜCK / ANGULAR CANTO ROMO
▲ 30x30 (12"x12") RT 20 mm

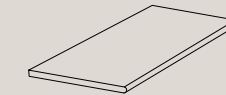

GRADINO BORDO CON TORO
ROUNDED STEP TREAD / NEZ DE MARCHE ARRONDI / GERUNDET STUFENPLATTE / PELDAÑO CANTO ROMO
▲ 45x90 (18"x36") RT 20 mm
▲ 30x60 (12"x24") RT 20 mm

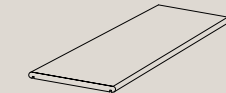

TOP BORDO TORO
TOP STEP TREAD / NEZ DE MARCHE HAUT / STUFENPLATTE TOP / TOP CANTO ROMO
▲ 30x60 (12"x24") RT 20 mm

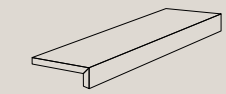

TERMINALE "L"
GLUED "L" TERMINAL / TERMINAL "L" COLLÉ / "L" STÜCK FLIESE GEKLEBT / TERMINAL "L" (PEGADO)
▲ 90x45x15 (36"x18"x6") RT 20 mm
▲ 60x20x5 (24"x8"x2") RT 20 mm

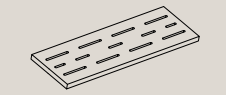

GRIGLIA
GRID / GRIL / GRILL / REJILLA
▲ 15x60 (6"x24") RT 20 mm

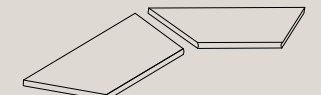

GRADINO ANGOLO INTERNO BORDO CON TORO
INT. CORNER STEP TREAD / ANGLE INT. NEZ DE MARCHE / INNENECKTRITTSTUFE / ANG. INT. CANTO ROMO
▲ 45x90 (18"x36") RT 20 mm
▲ 30x60 (12"x24") RT 20 mm



GRADINO ANGOLO ESTERNO BORDO CON TORO
EXT. CORNER STEP TREAD / ANGLE ÉXT. NEZ DE MARCHE / AUSSENECKTRITTSTUFE / ANG. EXT. CANTO ROMO
▲ 45x90 (18"x36") RT 20 mm
▲ 30x60 (12"x24") RT 20 mm



CORDOLO "L"
GLUED "L" TERMINAL / TERMINAL "L" COLLÉ / "L" STÜCK FLIESE GEKLEBT / CANTONERA "L" (PEGADA)
▲ 60x20x15 (24"x8"x6") RT 20 mm

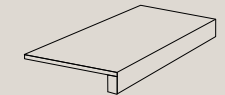

SCALINO INCOLLATO
STEP TREAD / NEZ DE MARCHE / STUFENPLATTE / PELDAÑO (PEGADO)
▲ 33x60x5 (13"x24"x2") RT 20 mm



ANGOLARE GRIGLIA
GRID / GRIL / GRILL / ANGULAR REJILLA
▲ 15x60 (6"x24") RT 20 mm

FORMATI

FORMATS / FORMATS / FORMATE / FORMATOS

	45x90 18"x36"	60x60 24"x24"
working size	446x895	596x596
	RT	RT
	K2 20 mm	K2 20 mm
EXTREME BEIGE	▲	▲
EXTREME GREY	▲	▲
EXTREME ANTHRACITE	▲	▲

▲ Structured R11

skywall

CONCRETE EFFECT

2

COLORI/
COLOURS
COULEURS
FARBE
COLORES

1

FORMATI/
SIZES
FORMATS
FORMATE
FORMATOS

1

SUPERFICI/
FINISHES
FINITIONS
OBERFLÄCHEN
ACABADOS

1

SPESSORI/
THICKNESS
ÉPAISSEUR
STÄRKE
ESPESOR



2

COLORI/

COLOURS / COULEURS / FARBE / COLORES

SKYWALL BEIGE



SKYWALL GREY



1

FORMATI/

SIZES / FORMATS / FORMATE / FORMATOS

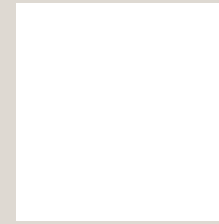

▲ 60x60 (24"x24") RT K2 20 mm



ANGOLARE BORDO CON TORO
CORNER STEP TREAD / NEZ DE MARCHÉ
ANGULAIRE / STUFENPLATTE ECKSTÜCK /
ANGULAR CANTO ROMO

▲ 30x30 (12"x12") RT 20 mm

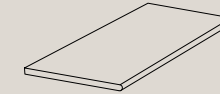

GRADINO BORDO CON TORO
ROUNDED STEP TREAD / NEZ DE MARCHÉ
ARRONDI / GERUNDET STUFENPLATTE /
PELDAÑO CANTO ROMO

▲ 30x60 (12"x24") RT 20 mm

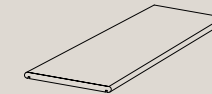

TOP BORDO TORO
TOP STEP TREAD / NEZ DE MARCHÉ HAUT /
STUFENPLATTE TOP / TOP CANTO ROMO

▲ 30x60 (12"x24") RT 20 mm

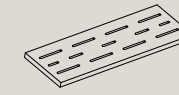

GRIGLIA
GRID / GRIL / GRILL / REJILLA

▲ 15x60 (6"x24") RT 20 mm

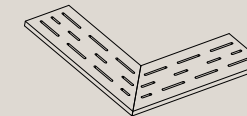

ANGOLARE GRIGLIA
GRID / GRIL / GRILL / ANGULAR REJILLA

▲ 15x60 (6"x24") RT 20 mm

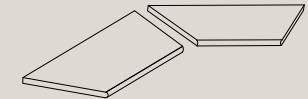

GRADINO ANGOLO INTERNO BORDO CON TORO
INT. CORNER STEP TREAD / ANGLE INT. NEZ DE MARCHÉ /
INNENECKTRITTSTUFE / ANG. INT. CANTO ROMO

▲ 30x60 (12"x24") RT 20 mm

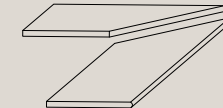

GRADINO ANGOLO ESTERNO BORDO CON TORO
EXT. CORNER STEP TREAD / ANGLE EXT. NEZ DE MARCHÉ /
AUSSENECKTRITTSTUFE / ANG. EXT. CANTO ROMO

▲ 30x60 (12"x24") RT 20 mm

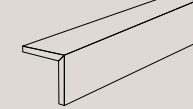

CORDOLO L
GLUED "L" TERMINAL / TERMINAL "L" COLLÉ /
"L" STÜCK FLIESE GEKLEBT / CANTONERA "L" (PEGADA)

▲ 60x20x15 (24"x8"x6") RT 20 mm

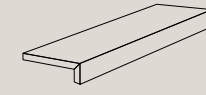

TERMINALE L
GLUED "L" TERMINAL / TERMINAL "L" COLLÉ /
"L" STÜCK FLIESE GEKLEBT / TERMINAL "L" (PEGADO)

▲ 60x20x5 (24"x8"x2") RT 20 mm

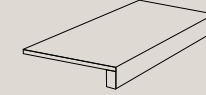

SCALINO INCOLLATO
STEP TREAD / NEZ DE MARCHÉ / STUFENPLATTE /
PELDAÑO (PEGADO)

▲ 33x60x5 (13"x24"x2") RT 20 mm

FORMATI

FORMATS / FORMATS / FORMATE / FORMATOS

	60x60 24"x24"
working size	596x596
	RT
	K2 20 mm
SKYWALL BEIGE	▲
SKYWALL GREY	▲

▲ Structured R11

urban

CONCRETE EFFECT

3

COLORI/
COLOURS
COULEURS
FARBE
COLORES

2

FORMATI/
SIZES
FORMATS
FORMATE
FORMATOS

1

SUPERFICI/
FINISHES
FINITIONS
OBERFLÄCHEN
ACABADOS

1

SPESSORI/
THICKNESS
ÉPAISSEUR
STÄRKE
ESPESOR



3

COLORI/

COLOURS / COULEURS / FARBE / COLORES

URBAN IVORY



URBAN GREY



URBAN ANTHRACITE



2

FORMATI/

SIZES / FORMATS / FORMATE / FORMATOS

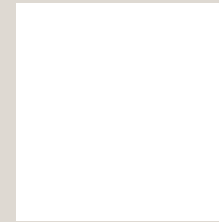

■ 60x60 (24"x24") RT 8,5 mm

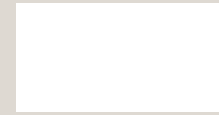

■ 30x60 (12"x24") RT 8,5 mm

1

PEZZI SPECIALI/

TRIMS / PIECES SPECIALES / FORMTEILE /
PIEZAS ESPECIALES



BATTISCOPA
BULLNOSE / PLINTHE / SOCKEL / RODAPIÉ
■ 7,2x60 (2,8"x24") RT 8,5 mm

FORMATI

FORMATS / FORMATS / FORMATE / FORMATOS

	60x60 24"x24"	30x60 12"x24"
working size	596x596	297x596
	RT	RT
	8,5 mm	8,5 mm
URBAN IVORY	■	■
URBAN GREY	■	■
URBAN ANTHRACITE	■	■

■ Grip R10

way

STONE EFFECT

3

COLORI/
COLOURS
COULEURS
FARBE
COLORES

2

FORMATI/
SIZES
FORMATS
FORMATE
FORMATOS

1

SUPERFICI/
FINISHES
FINITIONS
OBERFLÄCHEN
ACABADOS

1

SPESSORI/
THICKNESS
ÉPAISSEUR
STÄRKE
ESPESOR



3

COLORI/

COLOURS / COULEURS / FARBE / COLORES

WAY BEIGE



WAY GREY



WAY ANTHRACITE



2

FORMATI/

SIZES / FORMATS / FORMATE / FORMATOS



▲ 30x60 (12"x24") Not RT 8,5 mm



▲ 30x30 (12"x12") Not RT 8,5 mm

2

PEZZI SPECIALI/

TRIMS / PIECES SPECIALES / FORMTEILE /
PIEZAS ESPECIALES



BATTISCOPA
BULLNOSE / PLINTHE / SOCKEL / RODAPIÉ
▲ 8x30 (3"x12") Not RT 8,5 mm



TERMINALE L MONOLITICO
L TERMINAL / TERMINALE ELLE /
L STÜCK FLIESE / REMATE EN FORMA DE L
▲ 30x3,8x16,5 (12"x1 1/2"x6 1/2") Not RT 10 mm

FORMATI

FORMATS / FORMATS / FORMATE / FORMATOS

	30x60 12"x24"	30x30 12"x12"
working size	297x596	297x297
	Not RT	Not RT
	8,5 mm	8,5 mm
WAY BEIGE	▲	▲
WAY GREY	▲	▲
WAY ANTHRACITE	▲	▲

▲ Structured R11



K2 20 mm

56
COLORI/
COLOURS
COULEURS
FARBE
COLORES

13
FORMATI/
SIZES
FORMATS
FORMATE
FORMATOS

19
COLLEZIONI/
COLLECTIONS
COLLECTIONS
KOLLEKTIONEN
COLECCIONES

COLORI E FORMATI

COLORS AND SIZES / COULEURS ET FORMATS / FARBEN UND FORMATE / COLORES Y FORMATOS

120x240 48"x96"

PERCORSI SMART			PERCORSI EXTRA
Pietra di Bagnolo	Pietra di Bressa	Pietra di Lavis	Pietra di Vals

30x240 12"x96"

P. SMART			P. EXTRA
Pietra di Bagnolo	Pietra di Bressa	Pietra di Lavis	Pietra di Vals

90x90 36"x36"

MOOV				IKON		
Grey	Beige	Moka	Anthracite	Beige	Silver	White

30x60 12"x24"

CHORUS		
White	Beige	Silver

NOORD			
Grey	Gold	White	Anthracite

120x120 48"x48"

PERCORSI SMART				PERCORSI EXTRA		MOOV	
Pietra di Bagnolo	Pietra di Bressa	Pietra di Lavis	Pietra di Vals	Pietra di Barge	Grey	Moka	Anthracite

60x90 24"x36"

MIDLAKE				BRYSTONE		
Q.Beige	Porfido	Q.Grey	Ardesia	Grey	Ivory	Gold

22,5x45,4 9"x18"

MIDLAKE	
Q.Beige	Porfido

22,5x22,5 9"x9"

MIDLAKE	
Q.Beige	Porfido

45x90 18"x36"

PERCORSI EXTRA				PERCORSI SMART		
Pietra di Vals	Pietra di Faedis	Pietra di Combe	Pietra di Barge	Pietra di Bagnolo	Pietra di Bressa	Pietra di Lavis

EXTREME - Contract		
Grey	Beige	Anthracite

60x120 24"x48"

CHORUS			ELEMENT DESIGN		
Beige	Silver	White	Grey	Beige	White

BACK		CHORUS			NOORD			SKYWALL - Contract		
Grey	Anthracite	Beige	White	Silver	Grey	Gold	White	Anthracite	Beige	Grey

PERCORSI EXTRA		ARAN		
Pietra di Vals	Pietra di Barge	Walnut	Silver	Anthracite

PERCORSI EXTRA				MOOV			IKON			
P. di Vals	P. di Faedis	P. di Combe	P. di Barge	Grey	Beige	Moka	Anthracite	Beige	Silver	White

30x120 12"x48"

PERCORSI EXTRA		EVOKE	
Pietra di Vals	Pietra di Barge	Brown	Sand

40x120 16"x48"

BEAT
Grey

30x120 12"x48"

SOUL		
Grey	Blend	Walnut

PERCORSI SMART		PERCORSI QUARTZ		SIGHT		EXTREME - Contract	
P. di Bagnolo	Pietra di Bressa	P. di Lavis	White	Black	Grey	Beige	Anthracite

SWISSTONE - Contract		
Grey	Taupe	Anthracite

PEZZI SPECIALI K₂

TRIMS K₂ / PIECES SPECIALES K₂ / FORMTEILE K₂ / PIEZAS ESPECIALES K₂

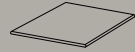

ANGOLARE BORDO CON TORO

CORNER STEP TREAD / NEZ DE MARCHE ANGULAIRE /
STUFENPLATTE ECKSTÜCK / ANGULAR CANTO ROMO

30x30 (12"x12") RT 20 mm

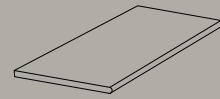

GRADINO BORDO CON TORO

ROUNDED STEP TREAD / NEZ DE MARCHE ARRONDI /
GERUNDET STUFENPLATTE / PELDAÑO CANTO ROMO

60x120 (24"x48") RT 20 mm

30x120 (12"x48") RT 20 mm

45x90 (18"x36") RT 20 mm

30x60 (12"x24") RT 20 mm

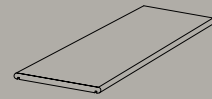

TOP BORDO TORO

TOP STEP TREAD / NEZ DE MARCHE HAUT /
STUFENPLATTE TOP / TOP CANTO ROMO

30x60 (12"x24") RT 20 mm

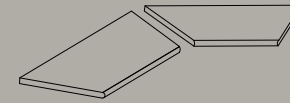

GRADINO ANGOLO INTERNO BORDO CON TORO

INT. CORNER STEP TREAD / ANGLE INT. NEZ DE MARCHE /
INNENECKTRITTSTUFE / ANG. INT. CANTO ROMO

60x120 (24"x48") RT 20 mm

30x120 (12"x48") RT 20 mm

45x90 (18"x36") RT 20 mm

30x60 (12"x24") RT 20 mm

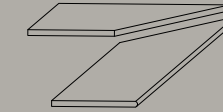

GRADINO ANGOLO ESTERNO BORDO CON TORO

EXT. CORNER STEP TREAD / ANGLE ÉXT. NEZ DE MARCHE /
AUSSENECKTRITTSTUFE / ANG. EXT. CANTO ROMO

60x120 (24"x48") RT 20 mm

30x120 (12"x48") RT 20 mm

45x90 (18"x36") RT 20 mm

30x60 (12"x24") RT 20 mm

BACK - BRYSTONE - CHORUS

EXTREME contract - IKON - MIDLAKE

MOOV - NOORD - PERCORSI EXTRA

PERCORSI QUARTZ - PERCORSI SMART

SIGHT - SKYWALL contract - SWISSTONE

contact

ARAN - BACK - BRYSTONE - CHORUS

ELEMENT DESIGN - EXTREME contract

EVOKE - IKON - MIDLAKE

MOOV - NOORD - PERCORSI EXTRA

PERCORSI QUARTZ - PERCORSI SMART

SIGHT - SOUL - SKYWALL contract -

SWISSTONE contact

BACK - BRYSTONE - CHORUS

EXTREME contract - IKON - MIDLAKE

MOOV - NOORD - PERCORSI EXTRA

PERCORSI QUARTZ - PERCORSI SMART

SIGHT - SKYWALL contract -

SWISSTONE contact

ARAN - BACK - BRYSTONE - CHORUS

ELEMENT DESIGN - EXTREME contract

EVOKE - IKON - MIDLAKE

MOOV - NOORD - PERCORSI EXTRA

PERCORSI QUARTZ - PERCORSI SMART

SIGHT - SOUL - SKYWALL contract -

SWISSTONE contact

ARAN - BACK - BRYSTONE - CHORUS

ELEMENT DESIGN - EXTREME contract

EVOKE - IKON - MIDLAKE

MOOV - NOORD - PERCORSI EXTRA

PERCORSI QUARTZ - PERCORSI SMART

SIGHT - SOUL - SKYWALL contract -

SWISSTONE contact

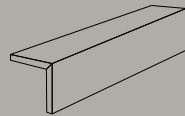

CORDOLO L

GLUED "L" TERMINAL / TERMINAL "L" COLLÉ /
"L" STÜCK FLIESE GEKLEBT / CANTONERA "L" (PEGADA)

60x20x15 (24"x8" x6") RT 20 mm

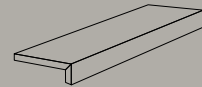

TERMINALE L

GLUED "L" TERMINAL / TERMINAL "L" COLLÉ /
"L" STÜCK FLIESE GEKLEBT / TERMINAL "L" (PEGADO)

120x45x15 (48"x18" x6") RT 20 mm

120x40x15 (48"x16" x6") RT 20 mm

90x45x15 (36"x18" x6") RT 20 mm

60x20x5 (24"x8" x2") RT 20 mm

60x33x5 (24"x13" x2") RT 20 mm

BACK - BRYSTONE - CHORUS

EXTREME contract - IKON - MIDLAKE

MOOV - NOORD - PERCORSI EXTRA

PERCORSI QUARTZ - PERCORSI SMART

SIGHT - SKYWALL contract - SWISSTONE

contact

ARAN - BACK - BEAT - BRYSTONE - CHORUS

ELEMENT DESIGN - EXTREME contract

EVOKE - IKON - MIDLAKE

MOOV - NOORD - PERCORSI EXTRA

PERCORSI QUARTZ - PERCORSI SMART

SIGHT - SKYWALL contract - SWISSTONE

contact

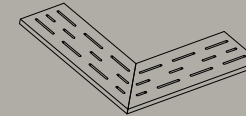

ANGOLARE GRIGLIA

GRID / GRIL / GRILL / ANGULAR REJILLA

15x60 (6"x24") RT 20 mm

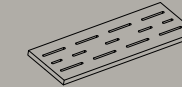

GRIGLIA

GRID / GRIL / GRILL / REJILLA

15x60 (6"x24") RT 20 mm

ARAN - BACK - BRYSTONE - CHORUS

ELEMENT DESIGN - EXTREME contract

IKON - MIDLAKE - MOOV - NOORD

PERCORSI EXTRA - PERCORSI QUARTZ

PERCORSI SMART - SIGHT

SKYWALL contract - SWISSTONE contact

ARAN - BACK - BRYSTONE - CHORUS

ELEMENT DESIGN - EXTREME contract

IKON - MIDLAKE - MOOV - NOORD

PERCORSI EXTRA - PERCORSI QUARTZ

PERCORSI SMART - SIGHT

SKYWALL contract - SWISSTONE contact

K2 20 mm



K3 30 mm

60x60

7

COLORI/
COLOURS
COULEURS
FARBE
COLORES

1

FORMATO/
SIZES
FORMATS
FORMATE
FORMATOS

3

COLLEZIONI/
COLLECTIONS
COLLECTIONS
KOLLEKTIONEN
COLECCIONES

COLORI E FINITURE

COLORS AND FINISHES / COULEURS ET FINITIONS / FARBEN UND OBERFLÄCHEN / COLORES Y ACABADOS

PERCORSI SMART



▲ Pietra di Bagnolo

MOOV

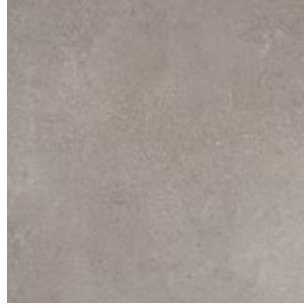

▲ Grey

PERCORSI EXTRA



▲ Pietra di Vals



▲ Pietra di Bressa



▲ Moka



▲ Pietra di Barge



▲ Pietra di Lavis

60x60 24"x24"



K3 30mm

specs & tech

340 / Legenda & simbologia

342 / Tabella formati-colori-finiture

354 / Tabella specifiche tecniche

370 / Tabella DIN51130-DIN51097

374 / Misure-pesi-imballi

380 / Certificazioni

394 / Manuale di posa, uso e manutenzione

412 / Condizioni generali di vendita

LEGENDA&SIMBOLOGIA /

LEGEND AND SYMBOLOLOGY / LÉGENDE ET SYMBOLOLOGIE / LEGENDE UND SYMBOLOLOGIE / LEYENDA Y SIMBOLOGÍA

FINITURE DI SUPERFICIE/

SURFACE FINISHES / FINITIONS DE SURFACE / OBERFLÄCHENVEREDELUNGEN / ACABADOS SUPERFICIALES



Natural



Natural R9



Natural R10



Grip R10



Structured R10



Grip R11



Structured R11



R12



Lappato



Silky



Glossy



3D

VARIAZIONI CROMATICHE/

COLOUR VARIATIONS / VARIATION CHROMATIQUES / FARBUNTERSCHIEDE / VARIACIÓN CROMÁTICAS



V0

Variazioni minime le differenze di tono tra i pezzi sono distinguibili ma simili /

Minor variations, the differences of shade amongst pieces are visible but similar / Variations minimales, les différences de nuance entre les pièces sont visibles mais identiques / Minimale Variationen, die Farbunterschiede zwischen den einzelnen Stücken sind erkennbar, aber es besteht große Ähnlichkeit / Variaciones mínimas, las piezas presentan entre sí diferencias de tono distinguibles, pero son similares



V1

Aspetto molto uniforme, i pezzi hanno lo stesso tono /

Particularly even appearance, pieces have the same shade / Aspect très uniforme, les pièces présentent la même nuance / Äußerst gleichförmiges Aussehen, die Stücke haben denselben Farbton / Aspecto muy uniforme, las piezas tienen el mismo tono



V2

Aspetto uniforme le differenze tra i pezzi sono minime /

Even appearance, the differences of shade amongst pieces are minimal / Aspect uniforme, les différences de nuance entre les pièces sont minimales / Gleichförmiges Aussehen, die Unterschiede zwischen den einzelnen Stücken sind minimal / Aspecto uniforme, las diferencias entre las piezas son mínimas



V3

Variazioni moderate, le differenze di tono tra i pezzi sono significative /

Moderate variations, the differences of shade amongst pieces are significant / Variations modérées, les différences de nuance entre les pièces sont significatives / Mäßige Variationen, die Farbunterschiede zwischen den einzelnen Stücken sind bedeutend / Variaciones moderadas, las diferencias de tono entre las piezas son significativas



V4

Variazioni sostanziali di tono, differenza tra i pezzi molto accentuata /

Substantial variations of shade, striking differences amongst pieces / Variations substantielles de nuance, très forte différence entre les pièces / Stärke Farbvariationen, die Unterschiede zwischen den einzelnen Stücken sind sehr markant / Variaciones sustanciales de tono, las diferencias de tono entre las piezas son muy acentuadas

CARATTERISTICHE TECNICHE/

TECHNICAL CHARACTERISTICS / CARACTERISTIQUES TECHNIQUES / TECHNISCHE EIGENSCHAFTEN / CARACTERÍSTICAS TÉCNICAS



Dimensioni ed aspetto /
Dimensions and surface / Taille et apparence / Größe und Aussehen / Dimensiones y aspecto superficial



Resistenza abrasione profonda /
Deep abrasion resistance / Résistance à l'abrasion profonde / Tiefenverschleissbeständigkeit / Resistencia a la abrasión profunda



Resistenza chimica /
Chemical resistance / Résistance chimique / Chemische Resistenz / Resistencia química



Assorbimento acqua /
Water absorption / Absorption d'eau / Wasseraufnahme / Absorción de agua



Resistenza shock termici /
Thermal shock resistance / Résistance aux écarts de température / Widerstandsfähigkeit gegen Temperaturschwankungen / Resistencia a los cambios de temperatura



Resistenza alle macchie /
Stain resistance / Résistance aux taches / Fleckenfestigkeit / Resistencia a las manchas



Resistenza a rottura /
Breaking strength / Module de rupture / Bruchlast / Módulo de rotura



Resistenza al gelo /
Frost resistance / Résistance au gel / Frostwiderstandsfähigkeit / Resistencia al hielo



Classificazione antiscivolo /
Assessment of slip resistance / Résistance au glissement / Bestimmung der Rutschhemmungsfähigkeit / Resistencia al resbalamiento

K2 20mm

PEZZI SPECIALI
TRIMS / PIECES SPECIALES / FORMTEILE / PIEZAS ESPECIALES









COLLEZIONI COLLECTIONS COLLECTIONS KOLLEKTIONEN COLECCIONES	ANGOLARE BORDO CON TORO CORNER STEP TREAD / NEZ DE MARCHE ANGULAIRE / STUFENPLATTE ECKSTÜCK / ANGULAR CANTO ROMO		GRADINO BORDO CON TORO ROUNDED STEP TREAD / NEZ DE MARCHE ARRONDI / GERUNDET STUFENPLATTE / PELDAÑO CANTO ROMO			TOP TOP STEP TREAD / NEZ DE MARCHE HAUT / STUFENPLATTE TOP / TOP CANTO ROMO	GRADINO ANGOLO INTERNO BORDO CON TORO INT. CORNER STEP TREAD / ANGLE INT. NEZ DE MARCHE / INNENECKTRITTSTUFE / ANG. INT. CANTO ROMO			
	30x30 (12"x12")	60x120 (24"x48")	30x120 (12"x48")	45x90 (18"x36")	30x60 (12"x24")	30x60 (12"x24")	60x120 (24"x48")	30x120 (12"x48")	45x90 (18"x36")	30x60 (12"x24")
ARAN		▲	▲				▲	▲		
BACK	▲				▲	▲				▲
BEAT										
BRYSTONE	▲			▲	▲	▲		▲	▲	
CHORUS	▲	▲	▲		▲	▲	▲	▲		▲
CODE										
ELEMENT DESIGN		▲	▲				▲	▲		
EVOKE			▲					▲		
EXTREME CONTRACT	▲			▲	▲	▲		▲	▲	
IKON	▲				▲	▲				▲
MIDLAKE	▲			▲	▲	▲		▲	▲	
MOOV	▲				▲	▲				▲
NOORD	▲	▲	▲		▲	▲	▲	▲		▲
PERCORSI EXTRA	▲	▲	▲	▲	▲	▲	▲	▲	▲	▲
PERCORSI QUARTZ	▲				▲	▲				▲
PERCORSI SMART	▲			▲	▲	▲		▲	▲	
SIGHT	▲				▲	▲				▲
SKYWALL CONTRACT	▲				▲	▲				▲
SOUL			▲					▲		
SWISSTONE CONTRACT	▲				▲	▲				▲

GRADINO ANGOLO ESTERNO BORDO CON TORO EXT. CORNER STEP TREAD / ANGLE EXT. NEZ DE MARCHE / AUSSENECKTRITTSTUFE / ANG. EXT. CANTO ROMO		CORDOLO L GLUED L TERMINAL / TERMINAL L COLLÉ / L STÜCK FLIESE GEKLEBT / GEKLEBT / TERMINAL L (PEGADO)		TERMINALE L GLUED L TERMINAL / TERMINAL L COLLÉ / L STÜCK FLIESE GEKLEBT / TERMINAL L (PEGADO)			ANGOLARE GRIGLIA GRID / GRILL / GRILL / ANGULAR REJILLA		GRIGLIA GRID / GRILL / GRILL / REJILLA		
60x120 (24"x48")	30x120 (12"x48")	45x90 (18"x36")	30x60 (12"x24")	60x20x15 (24"x8"x6")	120x45x15 (48"x18"x6")	120x40x10 (48"x16"x4")	90x45x15 (36"x18"x6")	60x33x5 (24"x13"x2")	60x20x5 (24"x8"x2")	60x15 (24"x6")	60x15 (24"x6")
▲	▲				▲					▲	▲
			▲	▲				▲	▲	▲	▲
		▲	▲	▲		▲				▲	▲
▲	▲				▲					▲	▲
	▲										
		▲	▲	▲			▲	▲	▲	▲	▲
								▲	▲	▲	▲
										▲	▲
										▲	▲
										▲	▲
										▲	▲
										▲	▲
										▲	▲
										▲	▲
	▲									▲	▲
										▲	▲

▲ Grip R11 | ▲ Structured R11

INFORMAZIONI TECNICHE

TECHNICAL FEATURES / INFORMATIONS TECHNIQUES / TECHNISCHE INFORMATIONEN / INFORMACIÓN TÉCNICA

DESCRIZIONE DESCRIPTION / DESCRIPTION BESCHREIBUNG / DESCRIPCIÓN	NORME REGULATION / NORME / NORM / NORMA	REQUISITI PRESCRITTI REQUIRED VALUES / EXIGENCES RÉGLEMENTAIRES / VORGESCHRIEBENE ANFORDERUNGEN / REQUISITOS ESTABLECIDOS
	EN 14411 - ISO 13006	<p>lunghezza-larghezza ±0,3% (±1,0 mm max) <i>length-width / longueur-largeur / Länge-Breite / longitud-ancho</i></p> <p>spessore ±5,0% (±0,5 mm max) <i>thickness / épaisseur / Stärke / espesor</i></p> <p>ortogonalità ±0,3% (±1,5 mm max) <i>rectangularity / orthogonalité / Rechtwinkligkeit / ortogonalidad</i></p> <p>rettilinearità ±0,3% (±0,8 mm max) <i>straightness / rectilignité / Geradlinigkeit / rectilineidad</i></p> <p>planarità ±0,4% (±1,8 mm max) <i>surface flatness / planéité / Ebenflächigkeit / planaridad</i></p> <p>qualità superficie ≥95% <i>surface quality / qualités surface / Oberflächenbeschaffenheit / cualidades superficie</i></p> <p>lunghezza-larghezza ±0,6% (±2,0 mm max) <i>length-width / longueur-largeur / Länge-Breite / longitud-ancho</i></p> <p>spessore ±5,0% (±0,5 mm max) <i>thickness / épaisseur / Stärke / espesor</i></p> <p>ortogonalità ±0,5% (±2,0 mm max) <i>rectangularity / orthogonalité / Rechtwinkligkeit / ortogonalidad</i></p> <p>rettilinearità ±0,5% (±1,5 mm max) <i>straightness / rectilignité / Geradlinigkeit / rectilineidad</i></p> <p>planarità ±0,5% (±2,0 mm max) <i>surface flatness / planéité / Ebenflächigkeit / planaridad</i></p> <p>qualità superficie ≥95% <i>surface quality / qualités surface / Oberflächenbeschaffenheit / cualidades superficie</i></p>
DIMENSIONI RETTIFICATO <i>SIZES RECTIFIED / FORMAT RECTIFIÉ / ABMESSUNGEN NACH DEM SCHLEIFEN / TAMAÑO RECTIFICADO</i>	UNI EN ISO 10545-2	
DIMENSIONI NON RETTIFICATO <i>SIZES NOT RECTIFIED / FORMAT NON RECTIFIÉ / ABMESSUNGEN VOR DEM SCHLEIFEN / TAMAÑO NO RECTIFICADO</i>	UNI EN ISO 10545-2	
 ASSORBIMENTO ACQUA <i>WATER ABSORPTION / ABSORPTION D'EAU / WASSERAUFNAHME / ABSORCIÓN DE AGUA</i>	UNI EN ISO 10545-3	≤0,5%
 RESISTENZA A ROTTURA <i>BREAKING STRENGTH / RÉSISTANCE À LA RUPTURE / BRUCHFESTIGKEIT / RESISTENCIA A LA ROTURA</i>	UNI EN ISO 10545-4	R≥35 N/mm² S≥700 N (<7,5 mm) S≥1300 N (≥7,5 mm)
 RESISTENZA ABRASIONE PROFONDA (UGL - Matt) <i>DEEP ABRASION RESISTANCE (UGL - Matt) / RÉSISTANCE À L'ABRASION PROFONDE (UGL - Matt) / TIEFENVERSCHLEISSBESTÄNDIGKEIT (UGL - Matt) / RESISTENCIA A LA ABRASIÓN PROFUNDA (UGL - Matt)</i>	UNI EN ISO 10545-6	≤175 mm ³
 RESIST. ABRASIONE SUPERFICIALE (GL - Lappato / Silky) <i>SURFACE ABRASION RESISTANCE (GL - Lappato / Silky) / RESIST. A L'ABRASION SUPERFICIELLE (GL - Rodé / Silky) / WIDERSTÄNDIGKEIT GEGEN OBERFLÄCHENVERSCHLEISS (GL - geklapp / silky) / RESIST. ABRASIÓN SUPERFICIAL (GL: esmaltado / Silky)</i>	UNI EN ISO 10545-6	dichiarare un valore / declare a value / déclarer une valeur / einen Wert angeben / declarar un valor
 RESISTENZA SHOCK TERMICI <i>THERMAL SHOCK RESISTANCE / RÉSISTANCE AUX ÉCARTS DE TEMPÉRATURE / WIDERSTANDSFÄHIGKEIT GEGEN TEMPERATURSCHWANKUNGEN / RESISTENCIA A LOS CAMBIOS DE TEMPERATURA</i>	UNI EN ISO 10545-9	resistenza / resistant / résistance / Widerständigkeit / resistencia
 RESISTENZA AL GELO <i>FROST RESISTANCE / RÉSISTANCE AU GEL / FROSTWIDERSTANDSFÄHIGKEIT / RESISTENCIA AL HIELO</i>	UNI EN ISO 10545-12	resistenza / resistant / résistance / Widerständigkeit / resistencia
 RESISTENZA CHIMICA <i>CHEMICAL RESISTANCE / RÉSISTANCE CHIMIQUE CHEMISCHE BESTÄNDIGKEIT / RESISTENCIA QUÍMICA</i>	UNI EN ISO 10545-13	resistenza / resistant / résistance / Widerständigkeit / resistencia
 RESISTENZA ALLE MACCHIE <i>STAIN RESISTANCE / RÉSISTANCE AUX TACHES / FLECKENFESTIGKEIT / RESISTENCIA A LAS MANCHAS</i>	UNI EN ISO 10545-14	pulibile / cleanable / nettoyable / kann gereinigt werden / lavable
	DIN 51130	R
	DIN 51097	A+B+C
 CLASSIFICAZIONE ANTISDRUCCIOLO <i>ASSESSMENT OF SLIP RESISTANCE / CLASSIFICATION ANTIGLISSE RUTSCHFESTIGKEITSKLASSE / CLASIFICACIÓN ANTIDESLIZANTE</i>	B.C.R.A. (COF)	>0,40 bagnato / wet
	ANSI A137.1 2012 (DCOF)	>0,42 bagnato / wet
	BS 7976-2:2002 (UK) (Pendulum Test Value)	0-24 scivoloso / slippery / glissant / Rutschig / resbaladizo 25-35 scivolosità moderata / moderately slippery / glissance modérée / mäßige Rutschgefahr / Deslizamiento moderado >36 basso rischio scivolamento / low slipping risk / risque de glissement faible / geringe Rutschgefahr / bajo riesgo de deslizamiento

Piastrelle pressate a secco - Conforme alla norma EN 14411 e ISO 13006 appendice G gruppo B1-a con E ≤0,5%

Dry pressed tiles - Compliant with standards EN 14411 and ISO 13006 annex G group B1-a with E ≤0,5% / Carreau pressé à sec - Conforme à la norme EN 14411 et ISO 13006 annexe G groupe B1-a avec E ≤0,5% / Trocken gepresste Fliesen - Erfüllen die Anforderungen der Norm en 14411 und ISO 13006 Anhang g Gruppe B1-a mit E ≤0,5% / Baldosas prensadas en seco - Conforme a las normas en 14411 e iso 13006, anexo g grupo B1-a con E ≤0,5 %

354/355

VALORI VALUES / VALEURS WERTE / VALORES	VALORI VALUES / VALEURS WERTE / VALORES	VALORI VALUES / VALEURS WERTE / VALORES	VALORI VALUES / VALEURS WERTE / VALORES
ALPI	ARAN	BACK	BEAT
-	CONFORME <i>COMPLIANT / CONFORME ANFORDERUNGEN ERFÜLLT / CONFORME</i>	CONFORME <i>COMPLIANT / CONFORME ANFORDERUNGEN ERFÜLLT / CONFORME</i>	CONFORME <i>COMPLIANT / CONFORME ANFORDERUNGEN ERFÜLLT / CONFORME</i>
CONFORME <i>COMPLIANT / CONFORME ANFORDERUNGEN ERFÜLLT / CONFORME</i>	-	CONFORME <i>COMPLIANT / CONFORME ANFORDERUNGEN ERFÜLLT / CONFORME 7,5x30</i>	-
≤0,1%	≤0,1%	≤0,1%	≤0,1%
9 mm R≥40 N/mm² S≥1500 N	9 mm R≥40 N/mm² S≥1500 N	20 mm R≥45 N/mm² S≥10000 N	9 mm R≥40 N/mm² S≥1500 N
≤150 mm ³	≤150 mm ³	≤150 mm ³	≤150 mm ³
-	-	-	-
CONFORME <i>COMPLIANT / CONFORME ANFORDERUNGEN ERFÜLLT / CONFORME</i>	CONFORME <i>COMPLIANT / CONFORME ANFORDERUNGEN ERFÜLLT / CONFORME</i>	CONFORME <i>COMPLIANT / CONFORME ANFORDERUNGEN ERFÜLLT / CONFORME</i>	CONFORME <i>COMPLIANT / CONFORME ANFORDERUNGEN ERFÜLLT / CONFORME</i>
CONFORME <i>COMPLIANT / CONFORME ANFORDERUNGEN ERFÜLLT / CONFORME</i>	CONFORME <i>COMPLIANT / CONFORME ANFORDERUNGEN ERFÜLLT / CONFORME</i>	CONFORME <i>COMPLIANT / CONFORME ANFORDERUNGEN ERFÜLLT / CONFORME</i>	CONFORME <i>COMPLIANT / CONFORME ANFORDERUNGEN ERFÜLLT / CONFORME</i>
CONFORME <i>COMPLIANT / CONFORME ANFORDERUNGEN ERFÜLLT / CONFORME</i>	CONFORME <i>COMPLIANT / CONFORME ANFORDERUNGEN ERFÜLLT / CONFORME</i>	CONFORME <i>COMPLIANT / CONFORME ANFORDERUNGEN ERFÜLLT / CONFORME</i>	CONFORME <i>COMPLIANT / CONFORME ANFORDERUNGEN ERFÜLLT / CONFORME</i>
CONFORME <i>COMPLIANT / CONFORME ANFORDERUNGEN ERFÜLLT / CONFORME</i>	CONFORME <i>COMPLIANT / CONFORME ANFORDERUNGEN ERFÜLLT / CONFORME</i>	CONFORME <i>COMPLIANT / CONFORME ANFORDERUNGEN ERFÜLLT / CONFORME</i>	CONFORME <i>COMPLIANT / CONFORME ANFORDERUNGEN ERFÜLLT / CONFORME</i>
R11 30x30 Not RT - 15x30 Not RT - 15x15 Not RT	R10 60x120 - 30x120 - 60x60 - 30x60 - 9,7x60 R11 30x60 - 60x120 K2	R9 120x120 - 60x120 - 60x60 - 40x60 30x60 - 20x60 - 9,7x60 - 6,4x60 - 3,1x60 R10 7,5x30 Not RT R11 60x120 - 90x90 K2 - 60x60 60x60 K2 - 30x60	R9 30x240 -30x120 - 20x120 R10 20x120 R11 40x120 K2
A+B+C Structured R11	A+B Structured R10 / A+B+C Structured R11	A+B Natural R9 / A+B+C Grip R11- Structured R10	A Natural R9 / A+B Grip R10 / A+B+C Structured R11
CONFORME <i>COMPLIANT / CONFORME ANFORDERUNGEN ERFÜLLT / CONFORME</i>	CONFORME <i>COMPLIANT / CONFORME ANFORDERUNGEN ERFÜLLT / CONFORME</i>	CONFORME <i>COMPLIANT / CONFORME ANFORDERUNGEN ERFÜLLT / CONFORME</i>	CONFORME <i>COMPLIANT / CONFORME ANFORDERUNGEN ERFÜLLT / CONFORME</i>
CONFORME <i>COMPLIANT / CONFORME ANFORDERUNGEN ERFÜLLT / CONFORME</i>	CONFORME <i>COMPLIANT / CONFORME ANFORDERUNGEN ERFÜLLT / CONFORME</i>	CONFORME <i>COMPLIANT / CONFORME ANFORDERUNGEN ERFÜLLT / CONFORME</i>	CONFORME <i>COMPLIANT / CONFORME ANFORDERUNGEN ERFÜLLT / CONFORME</i>
-	> 36 60x120 - 30x120 - 60x60 - 30x60 - 9,7x60 Grey/Silver/Anthracite/Walnut	-	> 36 20x120 Brown/Ivory/Grey/Taupe/Walnut

INFORMAZIONI TECNICHE

TECHNICAL FEATURES / INFORMATIONS TECHNIQUES / TECHNISCHE INFORMATIONEN / INFORMACIÓN TÉCNICA

DESCRIZIONE DESCRIPTION / DESCRIPTION BESCHREIBUNG / DESCRIPCIÓN	VALORI VALUES / VALEURS WERTE / VALORES	VALORI VALUES / VALEURS WERTE / VALORES
	BRYSTONE	CEMENTINE
DIMENSIONI RETTIFICATO SIZES RECTIFIED / FORMAT RECTIFIÉ / ABMESSUNGEN NACH DEM SCHLEIFEN / TAMAÑO RECTIFICADO	CONFORME COMPLIANT / CONFORME ANFORDERUNGEN ERFÜLLT / CONFORME	CONFORME COMPLIANT / CONFORME ANFORDERUNGEN ERFÜLLT / CONFORME
DIMENSIONI NON RETTIFICATO SIZES NOT RECTIFIED / FORMAT NON RECTIFIÉ / ABMESSUNGEN VOR DEM SCHLEIFEN / TAMAÑO NO RECTIFICADO	–	–
ASSORBIMENTO ACQUA WATER ABSORPTION / ABSORPTION D'EAU / WASSERAUFNAHME / ABSORCIÓN DE AGUA	≤0,1%	≤0,1%
RESISTENZA A ROTTURA BREAKING STRENGTH / RÉSISTANCE À LA RUPTURE / BRUCHFESTIGKEIT / RESISTENCIA A LA ROTURA	6 mm R≥40 N/mm ² S≥1000 N	9 mm R≥40 N/mm ² S≥1500 N
RESISTENZA ABRASIONE PROFONDA (UGL - Matt) DEEP ABRASION RESISTANCE (UGL - Matt) / RÉSISTANCE À L'ABRASION PROFONDE (UGL - Matt) / TIEFENVERSCHLEISSBESTÄNDIGKEIT (UGL - Matt) / RESISTENCIA A LA ABRASIÓN PROFUNDA (UGL - Matt)	≤150 mm ³	≤150 mm ³
RESIST. ABRASIONE SUPERFICIALE (GL - Lappato / Silky) SURFACE ABRASION RESISTANCE (GL - Lappato / Silky) / RESIST. A L'ABRASION SUPERFICIELLE (GL - Poisé / Silky) / WIDERSTÄNDIGKEIT GEGEN OBERFLÄCHENVERSCHLEISS (GL - geläppt / silky) / RESIST. ABRASIÓN SUPERFICIAL (GL - esmaltado / Silky)	–	–
RESISTENZA SHOCK TERMICI THERMAL SHOCK RESISTANCE / RÉSISTANCE AUX ÉCARTS DE TEMPÉRATURE / WIDERSTANDSFÄHIGKEIT GEGEN TEMPERATURSCHWANKUNGEN / RESISTENCIA A LOS CAMBIOS DE TEMPERATURA	CONFORME COMPLIANT / CONFORME ANFORDERUNGEN ERFÜLLT / CONFORME	CONFORME COMPLIANT / CONFORME ANFORDERUNGEN ERFÜLLT / CONFORME
RESISTENZA AL GELO FROST RESISTANCE / RÉSISTANCE AU GEL / FROSTWIDERSTANDSFÄHIGKEIT / RESISTENCIA AL HIELO	CONFORME COMPLIANT / CONFORME ANFORDERUNGEN ERFÜLLT / CONFORME	CONFORME COMPLIANT / CONFORME ANFORDERUNGEN ERFÜLLT / CONFORME
RESISTENZA CHIMICA CHEMICAL RESISTANCE / RÉSISTANCE CHIMIQUE CHEMISCHE BESTÄNDIGKEIT / RESISTENCIA QUÍMICA	CONFORME COMPLIANT / CONFORME ANFORDERUNGEN ERFÜLLT / CONFORME	CONFORME COMPLIANT / CONFORME ANFORDERUNGEN ERFÜLLT / CONFORME
RESISTENZA ALLE MACCHIE STAIN RESISTANCE / RÉSISTANCE AUX TACHES / FLECKENFESTIGKEIT / RESISTENCIA A LAS MANCHAS	CONFORME COMPLIANT / CONFORME ANFORDERUNGEN ERFÜLLT / CONFORME	CONFORME COMPLIANT / CONFORME ANFORDERUNGEN ERFÜLLT / CONFORME
CLASSIFICAZIONE ANTISDRUCCIOLO ASSESSMENT OF SLIP RESISTANCE / CLASSIFICATION ANTIGLISSE RUTSCHFESTIGKEITSKLASSE / CLASIFICACIÓN ANTIDESLIZANTE	R9 120x278 - 120x120 - 60x120 - 30x120 - 60x60 - 30x60 - 9,7x60 R10 60x120 - 60x60 - 30x60 R11 60x90 K2	R9 30x30
	A Natural R9 / A+B Structured R10 A+B+C Structured R11	A Natural R9
>36 60x120 - 60x60 - 30x60 White/Ivory/Gold/Avana	–	–

Piastrelle pressate a secco - Conforme alla norma EN 14411 e ISO 13006 appendice G gruppo B1-a con E ≤0,5%

Dry pressed tiles - Compliant with standards EN 14411 and ISO 13006 annex G group B1-a with E ≤0,5% / Carreau pressé à sec - Conforme à la norme EN 14411 et ISO 13006 annexe G groupe B1-a avec E ≤0,5% / Trocken gepresste Fliesen - Erfüllen die Anforderungen der Norm en 14411 und ISO 13006 Anhang g Gruppe B1-a mit E ≤0,5% / Baldosas prensadas en seco - Conforme a las normas en 14411 e iso 13006, anexo g grupo B1-a con E ≤0,5 %

356/357

VALORI VALUES / VALEURS WERTE / VALORES	VALORI VALUES / VALEURS WERTE / VALORES	VALORI VALUES / VALEURS WERTE / VALORES	VALORI VALUES / VALEURS WERTE / VALORES
CHORUS	CODE	ECLECTIC	ELEMENTS DESIGN
CONFORME COMPLIANT / CONFORME ANFORDERUNGEN ERFÜLLT / CONFORME	CONFORME COMPLIANT / CONFORME ANFORDERUNGEN ERFÜLLT / CONFORME	CONFORME COMPLIANT / CONFORME ANFORDERUNGEN ERFÜLLT / CONFORME	CONFORME COMPLIANT / CONFORME ANFORDERUNGEN ERFÜLLT / CONFORME
–	–	–	CONFORME COMPLIANT / CONFORME ANFORDERUNGEN ERFÜLLT / CONFORME 7,5x30 - exa
≤0,1%	≤0,1%	≤0,1%	≤0,1%
9 mm R≥40 N/mm ² S≥1500 N	20 mm R≥45 N/mm ² S≥10000 N	9 mm R≥40 N/mm ² S≥1500 N	6 mm R≥40 N/mm ² S≥1000 N
≤150 mm ³	≤150 mm ³	≤150 mm ³	≤150 mm ³
–	–	TEST DISPONIBILE TEST AVAILABLE / TEST DISPONIBLE / TEST VERFÜGBAR / PRUEBA DISPONIBLE	TEST DISPONIBILE TEST AVAILABLE / TEST DISPONIBLE / TEST VERFÜGBAR / PRUEBA DISPONIBLE
CONFORME COMPLIANT / CONFORME ANFORDERUNGEN ERFÜLLT / CONFORME	CONFORME COMPLIANT / CONFORME ANFORDERUNGEN ERFÜLLT / CONFORME	CONFORME COMPLIANT / CONFORME ANFORDERUNGEN ERFÜLLT / CONFORME	CONFORME COMPLIANT / CONFORME ANFORDERUNGEN ERFÜLLT / CONFORME
CONFORME COMPLIANT / CONFORME ANFORDERUNGEN ERFÜLLT / CONFORME	CONFORME COMPLIANT / CONFORME ANFORDERUNGEN ERFÜLLT / CONFORME	CONFORME COMPLIANT / CONFORME ANFORDERUNGEN ERFÜLLT / CONFORME	CONFORME COMPLIANT / CONFORME ANFORDERUNGEN ERFÜLLT / CONFORME
CONFORME COMPLIANT / CONFORME ANFORDERUNGEN ERFÜLLT / CONFORME	CONFORME COMPLIANT / CONFORME ANFORDERUNGEN ERFÜLLT / CONFORME	CONFORME COMPLIANT / CONFORME ANFORDERUNGEN ERFÜLLT / CONFORME	CONFORME COMPLIANT / CONFORME ANFORDERUNGEN ERFÜLLT / CONFORME
CONFORME COMPLIANT / CONFORME ANFORDERUNGEN ERFÜLLT / CONFORME	CONFORME COMPLIANT / CONFORME ANFORDERUNGEN ERFÜLLT / CONFORME	CONFORME COMPLIANT / CONFORME ANFORDERUNGEN ERFÜLLT / CONFORME	CONFORME COMPLIANT / CONFORME ANFORDERUNGEN ERFÜLLT / CONFORME
R9 120x120 - 60x120 - 30x120 - 75x75 37,5x75 - 60x60 - 30x60 - 9,7x60 R10 60x120 - 60x60 - 30x60 R11 60x120 - 60x60 - 30x60 - 60x120 K2 - 60x60 K2 - 30x60 K2	R9 60x120 - 30x120 - 60x60 - 40x60 - 30x60 - 20x60 - 9,7x60 R11 30x60	– Lappato 120x278 - 120x120 - 60x120 - 30x120 - 60x60 - 30x60 – Silky 120x278 - 120x120 - 60x120 - 30x120 - 60x60 - 30x60 R9 60x120 - 60x60 - 30x60	– Natural exa Not RT / – Glossy 7,5x30 Not RT / – 3D 50x110 / – Lappato 60x120 – 60x60 / R9 120x120 - 60x120 - 20x120 – 60x60 - 30x60 - 9,7x60 / R10 60x120 - 60x60 - 30x60 / R11 60x120 K2
A Natural R9 / A+B Natural R10 / A+B Grip R11	A Natural R9 / A+B+C Grip R11	– Lappato / – Silky / A Natural R9	– Natural / – Glossy / – 3D / – Lappato / A Natural R9 / A+B Structured R10 / A+B+C Structured R11
CONFORME COMPLIANT / CONFORME ANFORDERUNGEN ERFÜLLT / CONFORME	CONFORME COMPLIANT / CONFORME ANFORDERUNGEN ERFÜLLT / CONFORME	CONFORME (NO LAPPATO / SILKY) COMPLIANT / CONFORME ANFORDERUNGEN ERFÜLLT / CONFORME	CONFORME (NO EXA / 3D / NO LAPP) COMPLIANT / CONFORME ANFORDERUNGEN ERFÜLLT / CONFORME
CONFORME COMPLIANT / CONFORME ANFORDERUNGEN ERFÜLLT / CONFORME	CONFORME COMPLIANT / CONFORME ANFORDERUNGEN ERFÜLLT / CONFORME	CONFORME (NO LAPPATO / SILKY) COMPLIANT / CONFORME ANFORDERUNGEN ERFÜLLT / CONFORME	CONFORME (NO EXA / 3D / NO LAPP) COMPLIANT / CONFORME ANFORDERUNGEN ERFÜLLT / CONFORME
>36 60x120 - 60x60 - 30x60 Tobacco/Silver/Beige/Grey/White	–	–	>36 60x120 - 60x60 - 30x60 Ivory/Taupe/Silver/Grey/Black

INFORMAZIONI TECNICHE

TECHNICAL FEATURES / INFORMATIONS TECHNIQUES / TECHNISCHE INFORMATIONEN / INFORMACIÓN TÉCNICA

DESCRIZIONE DESCRIPTION / DESCRIPTION BESCHREIBUNG / DESCRIPCIÓN	VALORI VALUES / VALEURS WERTE / VALORES	VALORI VALUES / VALEURS WERTE / VALORES
	ELEMENTS LUX	EVOKE
DIMENSIONI RETTIFICATO SIZES RECTIFIED / FORMAT RECTIFIÉ / ABMESSUNGEN NACH DEM SCHLEIFEN / TAMAÑO RECTIFICADO	CONFORME COMPLIANT / CONFORME ANFORDERUNGEN ERFÜLLT / CONFORME	CONFORME COMPLIANT / CONFORME ANFORDERUNGEN ERFÜLLT / CONFORME
DIMENSIONI NON RETTIFICATO SIZES NOT RECTIFIED / FORMAT NON RECTIFIÉ / ABMESSUNGEN VOR DEM SCHLEIFEN / TAMAÑO NO RECTIFICADO	-	-
ASSORBIMENTO ACQUA WATER ABSORPTION / ABSORPTION D'EAU / WASSERAUFNAHME / ABSORCIÓN DE AGUA	≤0,1%	≤0,1%
RESISTENZA A ROTTURA BREAKING STRENGTH / RÉSISTANCE À LA RUPTURE / BRUCHFESTIGKEIT / RESISTENCIA A LA ROTURA	6 mm R≥40 N/mm ² S≥1000 N	9 mm R≥40 N/mm ² S≥1500 N
RESISTENZA ABRASIONE PROFONDA (UGL - Matt) DEEP ABRASION RESISTANCE (UGL - Matt) / RÉSISTANCE À L'ABRASION PROFONDE (UGL - Matt) / TIEFENVERSCHLEISSBESTÄNDIGKEIT (UGL - Matt) / RESISTENCIA A LA ABRASIÓN PROFUNDA (UGL - Matt)	≤150 mm ³	≤150 mm ³
RESIST. ABRASIONE SUPERFICIALE (GL - Lappato / Silky) SURFACE ABRASION RESISTANCE (GL - Lappato / Silky) / RÉSIST. À L'ABRASION SUPERFICIELLE (GL - Poisé / Silky) / WIDERSTÄNDIGKEIT GEGEN OBERFLÄCHENVERSCHLEISS (GL - geläppt / silky) / RESIST. ABRASIÓN SUPERFICIAL (GL: esmaltado / Silky)	TEST DISPONIBILE TEST AVAILABLE / TEST DISPONIBLE / TEST VERFÜGBAR / PRUEBA DISPONIBLE	-
RESISTENZA SHOCK TERMICI THERMAL SHOCK RESISTANCE / RÉSISTANCE AUX ÉCARTS DE TEMPÉRATURE / WIDERSTANDSFÄHIGKEIT GEGEN TEMPERATURSCHWANKUNGEN / RESISTENCIA A LOS CAMBIOS DE TEMPERATURA	CONFORME COMPLIANT / CONFORME ANFORDERUNGEN ERFÜLLT / CONFORME	CONFORME COMPLIANT / CONFORME ANFORDERUNGEN ERFÜLLT / CONFORME
RESISTENZA AL GELO FROST RESISTANCE / RÉSISTANCE AU GEL / FROSTWIDERSTANDSFÄHIGKEIT / RESISTENCIA AL HIELO	CONFORME COMPLIANT / CONFORME ANFORDERUNGEN ERFÜLLT / CONFORME	CONFORME COMPLIANT / CONFORME ANFORDERUNGEN ERFÜLLT / CONFORME
RESISTENZA CHIMICA CHEMICAL RESISTANCE RÉSISTANCE CHIMIQUE CHEMISCHE BESTÄNDIGKEIT RESISTENCIA QUÍMICA	CONFORME COMPLIANT / CONFORME ANFORDERUNGEN ERFÜLLT / CONFORME	CONFORME COMPLIANT / CONFORME ANFORDERUNGEN ERFÜLLT / CONFORME
RESISTENZA ALLE MACCHIE STAIN RESISTANCE / RÉSISTANCE AUX TACHES / FLECKENFESTIGKEIT / RESISTENCIA A LAS MANCHAS	CONFORME COMPLIANT / CONFORME ANFORDERUNGEN ERFÜLLT / CONFORME	CONFORME COMPLIANT / CONFORME ANFORDERUNGEN ERFÜLLT / CONFORME
	- Lappato / A Natural R9	A+B Natural R9 / A+B+C Structured R11
CLASSIFICAZIONE ANTISDRUCCIOLO ASSESSMENT OF SLIP RESISTANCE / CLASSIFICATION ANTIGLISSE RUTSCHFESTIGKEITSKLASSE/CLASIFICACIÓN ANTIDESLIZANTE	CONFORME (NO LAPPATO) COMPLIANT / CONFORME ANFORDERUNGEN ERFÜLLT / CONFORME	CONFORME COMPLIANT / CONFORME ANFORDERUNGEN ERFÜLLT / CONFORME
	CONFORME (NO LAPPATO) COMPLIANT / CONFORME ANFORDERUNGEN ERFÜLLT / CONFORME	CONFORME COMPLIANT / CONFORME ANFORDERUNGEN ERFÜLLT / CONFORME
	-	-

Piastrelle pressate a secco - Conforme alla norma EN 14411 e ISO 13006 appendice G gruppo B1-a con E ≤0,5%











Dry pressed tiles - Compliant with standards EN 14411 and ISO 13006 annex G group B1-a with E ≤0,5% / Carreau pressé à sec - Conforme à la norme EN 14411 et ISO 13006 annexe G groupe B1-a avec E ≤0,5% / Trocken gepresste Fliesen - Erfüllen die Anforderungen der Norm en 14411 und ISO 13006 Anhang g Gruppe B1-a mit E ≤0,5% / Baldosas prensadas en seco - Conforme a las normas en 14411 e iso 13006, anexo g grupo B1-a con E ≤0,5 %

358/359

VALORI VALUES / VALEURS WERTE / VALORES	VALORI VALUES / VALEURS WERTE / VALORES	VALORI VALUES / VALEURS WERTE / VALORES	VALORI VALUES / VALEURS WERTE / VALORES
GRANIGLIATI - LINEA TECNICA	IKON	INTERNO4	K-COLOR
-	CONFORME COMPLIANT / CONFORME ANFORDERUNGEN ERFÜLLT / CONFORME	CONFORME COMPLIANT / CONFORME ANFORDERUNGEN ERFÜLLT / CONFORME	-
CONFORME COMPLIANT / CONFORME ANFORDERUNGEN ERFÜLLT / CONFORME	-	-	CONFORME COMPLIANT / CONFORME ANFORDERUNGEN ERFÜLLT / CONFORME
≤0,1%	≤0,1%	≤0,1%	≤0,1%
9 mm R≥40 N/mm ² S≥1500 N	14 mm R≥45 N/mm ² S≥6000 N	6 mm R≥40 N/mm ² S≥1000 N	9 mm R≥40 N/mm ² S≥1500 N
20 mm R≥45 N/mm ² S≥10000 N	20 mm R≥45 N/mm ² S≥10000 N	6 mm R≥40 N/mm ² S≥1000 N	9 mm R≥40 N/mm ² S≥1500 N
≤150 mm ³	≤150 mm ³	≤150 mm ³	-
-	-	TEST DISPONIBILE TEST AVAILABLE / TEST DISPONIBLE / TEST VERFÜGBAR / PRUEBA DISPONIBLE	TEST DISPONIBILE TEST AVAILABLE / TEST DISPONIBLE / TEST VERFÜGBAR / PRUEBA DISPONIBLE
CONFORME COMPLIANT / CONFORME ANFORDERUNGEN ERFÜLLT / CONFORME	CONFORME COMPLIANT / CONFORME ANFORDERUNGEN ERFÜLLT / CONFORME	CONFORME COMPLIANT / CONFORME ANFORDERUNGEN ERFÜLLT / CONFORME	CONFORME COMPLIANT / CONFORME ANFORDERUNGEN ERFÜLLT / CONFORME
CONFORME COMPLIANT / CONFORME ANFORDERUNGEN ERFÜLLT / CONFORME	CONFORME COMPLIANT / CONFORME ANFORDERUNGEN ERFÜLLT / CONFORME	CONFORME COMPLIANT / CONFORME ANFORDERUNGEN ERFÜLLT / CONFORME	CONFORME COMPLIANT / CONFORME ANFORDERUNGEN ERFÜLLT / CONFORME
CONFORME COMPLIANT / CONFORME ANFORDERUNGEN ERFÜLLT / CONFORME	CONFORME COMPLIANT / CONFORME ANFORDERUNGEN ERFÜLLT / CONFORME	CONFORME COMPLIANT / CONFORME ANFORDERUNGEN ERFÜLLT / CONFORME	CONFORME COMPLIANT / CONFORME ANFORDERUNGEN ERFÜLLT / CONFORME
CONFORME COMPLIANT / CONFORME ANFORDERUNGEN ERFÜLLT / CONFORME	CONFORME COMPLIANT / CONFORME ANFORDERUNGEN ERFÜLLT / CONFORME	CONFORME COMPLIANT / CONFORME ANFORDERUNGEN ERFÜLLT / CONFORME	CONFORME COMPLIANT / CONFORME ANFORDERUNGEN ERFÜLLT / CONFORME
R9 30x30 Not RT R12 30x30 Not RT	R9 120x278 - 120x120 - 60x120 - 30x120 90x90 - 60x60 R10 120x120 - 60x120 - 30x120 - 60x60 30x60 - 9,7x60 R11 30x60 - 90x90 K2 - 60x60 K2	- Lappato 120x278 - 80x160 - 120x120 - 60x120 - 30x120 - 80x80 - 60x60 R9 60x120 - 80x80	- Natural 20x20 Not RT R10 20x20 Not RT
A Natural R9 / A+B+C Structured R11	A Natural R9 / A+B Grip R10 / A+B+C Grip R11	- Lappato / A Natural R9	- Natural / A Grip R10
CONFORME COMPLIANT / CONFORME ANFORDERUNGEN ERFÜLLT / CONFORME	CONFORME COMPLIANT / CONFORME ANFORDERUNGEN ERFÜLLT / CONFORME	CONFORME COMPLIANT / CONFORME ANFORDERUNGEN ERFÜLLT / CONFORME	CONFORME (NO NATURAL) COMPLIANT / CONFORME ANFORDERUNGEN ERFÜLLT / CONFORME
CONFORME COMPLIANT / CONFORME ANFORDERUNGEN ERFÜLLT / CONFORME	CONFORME COMPLIANT / CONFORME ANFORDERUNGEN ERFÜLLT / CONFORME	CONFORME COMPLIANT / CONFORME ANFORDERUNGEN ERFÜLLT / CONFORME	CONFORME (NO NATURAL) COMPLIANT / CONFORME ANFORDERUNGEN ERFÜLLT / CONFORME
-	> 36 120x120 (no Silver/Beige) - 60x120 - 30x120 - 60x60 - 30x60 - 9,7x60 Grey/Silver/White/Sky/Beige	-	-

INFORMAZIONI TECNICHE

TECHNICAL FEATURES / INFORMATIONS TECHNIQUES / TECHNISCHE INFORMATIONEN / INFORMACIÓN TÉCNICA

DESCRIZIONE DESCRIPTION / DESCRIPTION BESCHREIBUNG / DESCRIPCIÓN	VALORI VALUES / VALEURS WERTE / VALORES	VALORI VALUES / VALEURS WERTE / VALORES
	LANGHE	MIDLAKE
		
DIMENSIONI RETTIFICATO SIZES RECTIFIED / FORMAT RECTIFIÉ / ABMESSUNGEN NACH DEM SCHLEIFEN / TAMAÑO RECTIFICADO	–	CONFORME COMPLIANT / CONFORME ANFORDERUNGEN ERFÜLLT / CONFORME 60x90 K2
DIMENSIONI NON RETTIFICATO SIZES NOT RECTIFIED / FORMAT NON RECTIFIÉ / ABMESSUNGEN VOR DEM SCHLEIFEN / TAMAÑO NO RECTIFICADO	CONFORME COMPLIANT / CONFORME ANFORDERUNGEN ERFÜLLT / CONFORME	CONFORME COMPLIANT / CONFORME ANFORDERUNGEN ERFÜLLT / CONFORME
	ASSORBIMENTO ACQUA WATER ABSORPTION / ABSORPTION D'EAU / WASSERAUFNAHME / ABSORCIÓN DE AGUA	≤0,1%
	RESISTENZA A ROTTURA BREAKING STRENGTH / RÉSISTANCE À LA RUPTURE / BRUCHFESTIGKEIT / RESISTENCIA A LA ROTURA	9 mm R≥40 N/mm² S≥1500 N
	RESISTENZA ABRASIONE PROFONDA (UGL - Matt) DEEP ABRASION RESISTANCE (UGL - Matt) / RÉSISTANCE À L'ABRASION PROFONDE (UGL - Matt) / TIEFENVERSCHLEISSBESTÄNDIGKEIT (UGL - Matt) / RESISTENCIA A LA ABRASIÓN PROFUNDA (UGL - Matt)	≤150 mm³
	RESIST. ABRASIONE SUPERFICIALE (GL - Lappato / Silky) SURFACE ABRASION RESISTANCE (GL - Lappato / Silky) / RESIST. A L'ABRASION SUPERFICIELLE (GL - Poché / Silky) / WIDERSTÄNDIGKEIT GEGEN OBERFLÄCHENVERSCHLEISS (GL - geläppt / silky) / RESIST. ABRASIÓN SUPERFICIAL (GL - esmaltado / Silky)	–
	RESISTENZA SHOCK TERMICI THERMAL SHOCK RESISTANCE / RÉSISTANCE AUX ÉCARTS DE TEMPÉRATURE / WIDERSTANDSFÄHIGKEIT GEGEN TEMPERATURSCHWANKUNGEN / RESISTENCIA A LOS CAMBIOS DE TEMPERATURA	CONFORME COMPLIANT / CONFORME ANFORDERUNGEN ERFÜLLT / CONFORME
	RESISTENZA AL GELO FROST RESISTANCE / RÉSISTANCE AU GEL / FROSTWIDERSTANDSFÄHIGKEIT / RESISTENCIA AL HIELO	CONFORME COMPLIANT / CONFORME ANFORDERUNGEN ERFÜLLT / CONFORME
	RESISTENZA CHIMICA CHEMICAL RESISTANCE / RÉSISTANCE CHIMIQUE CHEMISCHE BESTÄNDIGKEIT / RESISTENCIA QUÍMICA	CONFORME COMPLIANT / CONFORME ANFORDERUNGEN ERFÜLLT / CONFORME
	RESISTENZA ALLE MACCHIE STAIN RESISTANCE / RÉSISTANCE AUX TACHES / FLECKENFESTIGKEIT / RESISTENCIA A LAS MANCHAS	CONFORME COMPLIANT / CONFORME ANFORDERUNGEN ERFÜLLT / CONFORME
	R10 15x15 Not RT	R11 22,5x45,3 Not RT - 22,5x22,5 Not RT - 60x90 K2 - 22,5x45,4 K2 Not RT - 22,5x22,5 K2 Not RT
	A+B Structured R10	A+B+C Structured R11
	CLASSIFICAZIONE ANTISDRUCCIOLO ASSESSMENT OF SLIP RESISTANCE / CLASSIFICATION ANTIGLISSE RUTSCHFESTIGKEITSKLASSECLASIFICACIÓN ANTIDESLIZANTE	CONFORME COMPLIANT / CONFORME ANFORDERUNGEN ERFÜLLT / CONFORME
	CONFORME COMPLIANT / CONFORME ANFORDERUNGEN ERFÜLLT / CONFORME	CONFORME COMPLIANT / CONFORME ANFORDERUNGEN ERFÜLLT / CONFORME
	>36 15x15 Bra/Contemilia/Gavi/Monforte	–

Piastrelle pressate a secco - Conforme alla norma EN 14411 e ISO 13006 appendice G gruppo B1-a con E ≤0,5%









Dry pressed tiles - Compliant with standards EN 14411 and ISO 13006 annex G group B1-a with E ≤0,5% / Carreau pressé à sec - Conforme à la norme EN 14411 et ISO 13006 annexe g groupe B1-a avec E ≤0,5% / Trocken gepresste Fliesen - Erfüllen die Anforderungen der Norm en 14411 und ISO 13006 Anhang g Gruppe B1-a mit E ≤0,5% / Baldosas prensadas en seco - Conforme a las normas en 14411 e iso 13006, anexo g grupo B1-a con E ≤0,5 %

360/361

VALORI VALUES / VALEURS WERTE / VALORES	VALORI VALUES / VALEURS WERTE / VALORES	VALORI VALUES / VALEURS WERTE / VALORES	VALORI VALUES / VALEURS WERTE / VALORES
MOOV	NOORD	PERCORSI EXTRA	PERCORSI QUARTZ
CONFORME COMPLIANT / CONFORME ANFORDERUNGEN ERFÜLLT / CONFORME	CONFORME COMPLIANT / CONFORME ANFORDERUNGEN ERFÜLLT / CONFORME	CONFORME COMPLIANT / CONFORME ANFORDERUNGEN ERFÜLLT / CONFORME	CONFORME COMPLIANT / CONFORME ANFORDERUNGEN ERFÜLLT / CONFORME
CONFORME COMPLIANT / CONFORME ANFORDERUNGEN ERFÜLLT / CONFORME 45x45 - 7,5x30	–	–	–
≤0,1% / K3 (≤0,5%)	≤0,1%	≤0,1% / K3 (≤0,5%)	≤0,1%
6 mm R≥40N/mm² S≥1000 N	9 mm 20 mm R≥40 N/mm² S≥1500 N	9 mm 20 mm 30 mm R≥40 N/mm² R≥45 N/mm² S≥1500 N	9 mm 20 mm 30 mm R≥40 N/mm² R≥45 N/mm² S≥1500 N
9 mm 20 mm 30 mm R≥40N/mm² R≥45N/mm² S≥10000 N	30 mm R≥45N/mm² S≥25000 N	9 mm 20 mm 30 mm R≥45 N/mm² R≥45 N/mm² S≥25000 N	9 mm 20 mm 30 mm R≥45 N/mm² R≥45 N/mm² S≥25000 N
≤150 mm³	≤150 mm³	≤150 mm³	≤150 mm³
–	–	–	–
CONFORME COMPLIANT / CONFORME ANFORDERUNGEN ERFÜLLT / CONFORME	CONFORME COMPLIANT / CONFORME ANFORDERUNGEN ERFÜLLT / CONFORME	CONFORME COMPLIANT / CONFORME ANFORDERUNGEN ERFÜLLT / CONFORME	CONFORME COMPLIANT / CONFORME ANFORDERUNGEN ERFÜLLT / CONFORME
CONFORME COMPLIANT / CONFORME ANFORDERUNGEN ERFÜLLT / CONFORME	CONFORME COMPLIANT / CONFORME ANFORDERUNGEN ERFÜLLT / CONFORME	CONFORME COMPLIANT / CONFORME ANFORDERUNGEN ERFÜLLT / CONFORME	CONFORME COMPLIANT / CONFORME ANFORDERUNGEN ERFÜLLT / CONFORME
CONFORME COMPLIANT / CONFORME ANFORDERUNGEN ERFÜLLT / CONFORME	CONFORME COMPLIANT / CONFORME ANFORDERUNGEN ERFÜLLT / CONFORME	CONFORME COMPLIANT / CONFORME ANFORDERUNGEN ERFÜLLT / CONFORME	CONFORME COMPLIANT / CONFORME ANFORDERUNGEN ERFÜLLT / CONFORME
CONFORME COMPLIANT / CONFORME ANFORDERUNGEN ERFÜLLT / CONFORME	CONFORME COMPLIANT / CONFORME ANFORDERUNGEN ERFÜLLT / CONFORME	CONFORME COMPLIANT / CONFORME ANFORDERUNGEN ERFÜLLT / CONFORME	CONFORME COMPLIANT / CONFORME ANFORDERUNGEN ERFÜLLT / CONFORME
R9 120x278 - 120x240 - 120x120 - 60x120 30x120 - 20x120 - 75x75 - 60x60 - 30x60 - 14,7x60 - 9,7x60 - 6,4x60 - 3,1x60 - 45x45 Not RT / R10 120x120 - 60x120 - 60x60 - 30x60 - 7,5x30 Not RT / R11 60x120 - 60x60 - 30x60 - 120x120 K2 - 90x90 K2 - 60x60 K2 - 60x60 K3	R10 120x120 - 60x120 - 30x120 - 80x80 - 60x60 - 30x60 - 9,7x60 R11 120x120 K2 - 60x60 K2 - 30x60 K2	R9 60x120 - 60x60 - 40x60 - 30x60 - 20x60 - 30x30 / R10 60x120 - 60x60 - 30x60 / R11 60x120 - 60x60 - 40x60 - 30x60 - 20x60 - 30x30 - 120x240 K2 - 30x240 K2 - 120x120 K2 - 60x120 K2 - 30x120 K2 - 45x90 K2 - 60x60 K2 - 60x60 K3	R9 60x60 - 40x60 - 30x60 - 20x60 R11 60x60 - 40x60 - 30x60 - 20x60 - 60x60 K2
A Natural R9 / A+B Structured R10 - Grip R10 / A+B+C Grip R11	A+B Natural R10 / A+B+C Grip R11	A Natural R9 / A+B Structured R10 / A+B+C Structured R11 (PIETRA DI BARGE A+B , altri colori A+B+C)	A Natural R9 / A+B+C Structured R11
CONFORME COMPLIANT / CONFORME ANFORDERUNGEN ERFÜLLT / CONFORME	CONFORME COMPLIANT / CONFORME ANFORDERUNGEN ERFÜLLT / CONFORME	CONFORME COMPLIANT / CONFORME ANFORDERUNGEN ERFÜLLT / CONFORME	CONFORME COMPLIANT / CONFORME ANFORDERUNGEN ERFÜLLT / CONFORME
CONFORME COMPLIANT / CONFORME ANFORDERUNGEN ERFÜLLT / CONFORME	CONFORME COMPLIANT / CONFORME ANFORDERUNGEN ERFÜLLT / CONFORME	CONFORME COMPLIANT / CONFORME ANFORDERUNGEN ERFÜLLT / CONFORME	CONFORME COMPLIANT / CONFORME ANFORDERUNGEN ERFÜLLT / CONFORME
>36 120x120 - 60x120 - 60x60 - 30x60 Grey/Anthracite/Moka/Ivory	>36 120x120 - 60x120 - 30x120 - 80x80 60x60 - 30x60 - 9,7x60 Anthracite/Grey/Taupe/Gold/White	>36 60x120 - 60x60 - 30x60 Pietra di Vals/Pietra di Barge/ Pietra di Faedis	–

INFORMAZIONI TECNICHE

TECHNICAL FEATURES / INFORMATIONS TECHNIQUES / TECHNISCHE INFORMATIONEN / INFORMACIÓN TÉCNICA

DESCRIZIONE DESCRIPTION / DESCRIPTION BESCHREIBUNG / DESCRIPCIÓN	VALORI VALUES / VALEURS WERTE / VALORES	VALORI VALUES / VALEURS WERTE / VALORES
	PERCORSI SMART	PIETRE DI KEOPE
DIMENSIONI RETTIFICATO SIZES RECTIFIED / FORMAT RECTIFIÉ / ABMESSUNGEN NACH DEM SCHLEIFEN / TAMAÑO RECTIFICADO	CONFORME COMPLIANT / CONFORME ANFORDERUNGEN ERFÜLLT / CONFORME	–
DIMENSIONI NON RETTIFICATO SIZES NOT RECTIFIED / FORMAT NON RECTIFIÉ / ABMESSUNGEN VOR DEM SCHLEIFEN / TAMAÑO NO RECTIFICADO	CONFORME COMPLIANT / CONFORME ANFORDERUNGEN ERFÜLLT / CONFORME 15x30	CONFORME COMPLIANT / CONFORME ANFORDERUNGEN ERFÜLLT / CONFORME
 ASSORBIMENTO ACQUA WATER ABSORPTION / ABSORPTION D'EAU / WASSERAUFNAHME / ABSORCIÓN DE AGUA	≤0,1% / K3 (≤0,5%)	≤0,1%
 RESISTENZA A ROTTURA BREAKING STRENGTH / RÉSISTANCE À LA RUPTURE / BRUCHFESTIGKEIT / RESISTENCIA A LA ROTURA	9 mm R≥40 N/mm ² S≥1500 N	8,6 mm R≥40 N/mm ² S≥1500 N
 RESISTENZA ABRASIONE PROFONDA (UGL - Matt) DEEP ABRASION RESISTANCE (UGL - Matt) / RÉSISTANCE À L'ABRASION PROFONDE (UGL - Matt) / TIEFENVERSCHLEISSBESTÄNDIGKEIT (UGL - Matt) / RESISTENCIA A LA ABRASIÓN PROFUNDA (UGL - Matt)	≤150 mm ³	≤150 mm ³
 RESIST. ABRASIONE SUPERFICIALE (GL - Lappato / Silky) SURFACE ABRASION RESISTANCE (GL - Lappato / Silky) / RESIST. A L'ABRASION SUPERFICIELLE (GL - Poché / Silky) / WIDERSTÄNDIGKEIT GEGEN OBERFLÄCHENVERSCHLEISS (GL - geläppt / silky) / RESIST.ABRASIÓN SUPERFICIAL (GL-esmaltado / Silky)	–	–
 RESISTENZA SHOCK TERMICI THERMAL SHOCK RESISTANCE / RÉSISTANCE AUX ÉCARTS DE TEMPÉRATURE / WIDERSTANDSFÄHIGKEIT GEGEN TEMPERATURSCHWANKUNGEN / RESISTENCIA A LOS CAMBIOS DE TEMPERATURA	CONFORME COMPLIANT / CONFORME ANFORDERUNGEN ERFÜLLT / CONFORME	CONFORME COMPLIANT / CONFORME ANFORDERUNGEN ERFÜLLT / CONFORME
 RESISTENZA AL GELO FROST RESISTANCE / RÉSISTANCE AU GEL / FROSTWIDERSTANDSFÄHIGKEIT / RESISTENCIA AL HIELO	CONFORME COMPLIANT / CONFORME ANFORDERUNGEN ERFÜLLT / CONFORME	CONFORME COMPLIANT / CONFORME ANFORDERUNGEN ERFÜLLT / CONFORME
 RESISTENZA CHIMICA CHEMICAL RESISTANCE / RÉSISTANCE CHIMIQUE CHEMISCHE BESTÄNDIGKEIT / RESISTENCIA QUÍMICA	CONFORME COMPLIANT / CONFORME ANFORDERUNGEN ERFÜLLT / CONFORME	CONFORME COMPLIANT / CONFORME ANFORDERUNGEN ERFÜLLT / CONFORME
 RESISTENZA ALLE MACCHIE STAIN RESISTANCE / RÉSISTANCE AUX TACHES / FLECKENFESTIGKEIT / RESISTENCIA A LAS MANCHAS	CONFORME COMPLIANT / CONFORME ANFORDERUNGEN ERFÜLLT / CONFORME	CONFORME COMPLIANT / CONFORME ANFORDERUNGEN ERFÜLLT / CONFORME
	R9 60x60 - 40x60 - 30x60 - 20x60 R11 60x60 - 40x60 - 30x60 - 20x60 - 15x30 Not RT - 120x240 K2 - 30x240 K2 - 120x120 K2 - 45x90 K2 - 60x60 K2 - 60x60 K3	R11 30x30 Not RT
	A Natural R9 / A+B+C Structured R11	A+B+C Structured R11
 CLASSIFICAZIONE ANTISDRUCCIOLO ASSESSMENT OF SLIP RESISTANCE / CLASSIFICATION ANTIGLISSE RUTSCHFESTIGKEITSKLASSECLASIFICACIÓN ANTIDESLIZANTE	CONFORME COMPLIANT / CONFORME ANFORDERUNGEN ERFÜLLT / CONFORME	CONFORME COMPLIANT / CONFORME ANFORDERUNGEN ERFÜLLT / CONFORME
	CONFORME COMPLIANT / CONFORME ANFORDERUNGEN ERFÜLLT / CONFORME	CONFORME COMPLIANT / CONFORME ANFORDERUNGEN ERFÜLLT / CONFORME
	–	–

Piastrelle pressate a secco - Conforme alla norma EN 14411 e ISO 13006 appendice G gruppo B1-a con E ≤0,5%













Dry pressed tiles - Compliant with standards EN 14411 and ISO 13006 annex G group B1-a with E ≤0,5% / Carreau pressé à sec - Conforme à la norme EN 14411 et ISO 13006 annexe G groupe B1-a avec E ≤0,5% / Trocken gepresste Fliesen - Erfüllen die Anforderungen der Norm en 14411 und ISO 13006 Anhang g Gruppe B1-a mit E ≤0,5% / Baldosas prensadas en seco - Conforme a las normas en 14411 e iso 13006, anexo g grupo B1-a con E ≤0,5 %

362/363

VALORI VALUES / VALEURS WERTE / VALORES	VALORI VALUES / VALEURS WERTE / VALORES	VALORI VALUES / VALEURS WERTE / VALORES	VALORI VALUES / VALEURS WERTE / VALORES
POINT	SIGHT	SOUL	SUITE
–	CONFORME COMPLIANT / CONFORME ANFORDERUNGEN ERFÜLLT / CONFORME	CONFORME COMPLIANT / CONFORME ANFORDERUNGEN ERFÜLLT / CONFORME	CONFORME COMPLIANT / CONFORME ANFORDERUNGEN ERFÜLLT / CONFORME
CONFORME COMPLIANT / CONFORME ANFORDERUNGEN ERFÜLLT / CONFORME	–	–	–
≤0,1%	≤0,1%	≤0,1%	≤0,1%
9 mm R≥40 N/mm ² S≥1500 N	20 mm R≥45 N/mm ² S≥10000 N	9 mm R≥40 N/mm ² S≥1500 N	20 mm R≥45 N/mm ² S≥10000 N
≤150 mm ³	≤150 mm ³	≤150 mm ³	≤150 mm ³
–	–	–	–
CONFORME COMPLIANT / CONFORME ANFORDERUNGEN ERFÜLLT / CONFORME	CONFORME COMPLIANT / CONFORME ANFORDERUNGEN ERFÜLLT / CONFORME	CONFORME COMPLIANT / CONFORME ANFORDERUNGEN ERFÜLLT / CONFORME	CONFORME COMPLIANT / CONFORME ANFORDERUNGEN ERFÜLLT / CONFORME
CONFORME COMPLIANT / CONFORME ANFORDERUNGEN ERFÜLLT / CONFORME	CONFORME COMPLIANT / CONFORME ANFORDERUNGEN ERFÜLLT / CONFORME	CONFORME COMPLIANT / CONFORME ANFORDERUNGEN ERFÜLLT / CONFORME	CONFORME COMPLIANT / CONFORME ANFORDERUNGEN ERFÜLLT / CONFORME
CONFORME COMPLIANT / CONFORME ANFORDERUNGEN ERFÜLLT / CONFORME	CONFORME COMPLIANT / CONFORME ANFORDERUNGEN ERFÜLLT / CONFORME	CONFORME COMPLIANT / CONFORME ANFORDERUNGEN ERFÜLLT / CONFORME	CONFORME COMPLIANT / CONFORME ANFORDERUNGEN ERFÜLLT / CONFORME
CONFORME COMPLIANT / CONFORME ANFORDERUNGEN ERFÜLLT / CONFORME	CONFORME COMPLIANT / CONFORME ANFORDERUNGEN ERFÜLLT / CONFORME	CONFORME COMPLIANT / CONFORME ANFORDERUNGEN ERFÜLLT / CONFORME	CONFORME COMPLIANT / CONFORME ANFORDERUNGEN ERFÜLLT / CONFORME
R11 30x60 Not RT - 30x30 Not RT - 15x30 Not RT - 15x15 Not RT	R11 60x60 K2	R9 30x240 - 25x150 - 12,3x150 - 8,1x150 R11 30x120 K2	- 3D 30x120 R9 120x120 - 60x120 - 30x120 - 60x60 30x60 - 20x60 - 9,7x60 R11 30x60
A+B+C Structured R11	A+B+C Structured R11	A Natural R9 / A+B+C Structured R11	- 3D / A Natural R9 / A+B Structured R11
CONFORME COMPLIANT / CONFORME ANFORDERUNGEN ERFÜLLT / CONFORME	CONFORME COMPLIANT / CONFORME ANFORDERUNGEN ERFÜLLT / CONFORME	CONFORME COMPLIANT / CONFORME ANFORDERUNGEN ERFÜLLT / CONFORME	CONFORME (NO 3D) COMPLIANT / CONFORME ANFORDERUNGEN ERFÜLLT / CONFORME
CONFORME COMPLIANT / CONFORME ANFORDERUNGEN ERFÜLLT / CONFORME	CONFORME COMPLIANT / CONFORME ANFORDERUNGEN ERFÜLLT / CONFORME	CONFORME COMPLIANT / CONFORME ANFORDERUNGEN ERFÜLLT / CONFORME	CONFORME (NO 3D) COMPLIANT / CONFORME ANFORDERUNGEN ERFÜLLT / CONFORME
–	–	–	–

INFORMAZIONI TECNICHE

TECHNICAL FEATURES / INFORMATIONS TECHNIQUES / TECHNISCHE INFORMATIONEN / INFORMACIÓN TÉCNICA

DESCRIZIONE <i>DESCRIPTION / DESCRIPTION BESCHREIBUNG / DESCRIPCIÓN</i>	VALORI <i>VALUES / VALEURS WERTE / VALORES</i>
	SUNRISE
	
DIMENSIONI RETTIFICATO <i>SIZES RECTIFIED / FORMAT RECTIFIÉ / ABMESSUNGEN NACH DEM SCHLEIFEN / TAMAÑO RECTIFICADO</i>	CONFORME <i>COMPLIANT / CONFORME ANFORDERUNGEN ERFÜLLT / CONFORME</i>
	
DIMENSIONI NON RETTIFICATO <i>SIZES NOT RECTIFIED / FORMAT NON RECTIFIÉ / ABMESSUNGEN VOR DEM SCHLEIFEN / TAMAÑO NO RECTIFICADO</i>	–
	
ASSORBIMENTO ACQUA <i>WATER ABSORPTION / ABSORPTION D'EAU / WASSERAUFNAHME / ABSORCIÓN DE AGUA</i>	≤ 0,1%
	
RESISTENZA A ROTTURA <i>BREAKING STRENGHT / RÉSISTANCE À LA RUPTURE / BRUCHFESTIGKEIT / RESISTENCIA A LA ROTURA</i>	9 mm R≥40 N/mm² S≥1500 N
	
RESISTENZA ABRASIONE PROFONDA (UGL – Matt) <i>DEEP ABRASION RESISTANCE (UGL - Matt) / RÉSISTANCE À L'ABRASION PROFONDE (UGL - Matt) / TIEFENVERSCHLEISSBESTÄNDIGKEIT (UGL - Matt) / RESISTENCIA A LA ABRASIÓN PROFUNDA (UGL - Matt)</i>	≤ 150 mm³
	
RESIST. ABRASIONE SUPERFICIALE (GL – Lappato / Silky) <i>SURFACE ABRASION RESISTANCE (GL - Lappato / Silky) / RÉSIST. À L'ABRASION SUPERFICIELLE (GL - Poché / Silky) / WIDERSTÄNDIGKEIT GEGEN OBERFLÄCHENVERSCHLEISS (GL-geläppt / silky) / RESIST.ABRASIÓN SUPERFICIAL (GL:esmaltado / Silky)</i>	–
	
RESISTENZA SHOCK TERMICI <i>THERMAL SHOCK RESISTANCE / RÉSISTANCE AUX ÉCARTS DE TEMPÉRATURE / WIDERSTANDSFÄHIGKEIT GEGEN TEMPERATURSCHWANKUNGEN / RESISTENCIA A LOS CAMBIOS DE TEMPERATURA</i>	CONFORME <i>COMPLIANT / CONFORME ANFORDERUNGEN ERFÜLLT / CONFORME</i>
	
RESISTENZA AL GELO <i>FROST RESISTANCE / RÉSISTANCE AU GEL / FROSTWIDERSTANDSFÄHIGKEIT / RESISTENCIA AL HIELO</i>	CONFORME <i>COMPLIANT / CONFORME ANFORDERUNGEN ERFÜLLT / CONFORME</i>
	
RESISTENZA CHIMICA <i>CHEMICAL RESISTANCE RÉSISTANCE CHIMIQUE CHEMISCHE BESTÄNDIGKEIT RESISTENCIA QUÍMICA</i>	CONFORME <i>COMPLIANT / CONFORME ANFORDERUNGEN ERFÜLLT / CONFORME</i>
	
RESISTENZA ALLE MACCHIE <i>STAIN RESISTANCE / RÉSISTANCE AUX TACHES / FLECKENFESTIGKEIT / RESISTENCIA A LAS MANCHAS</i>	CONFORME <i>COMPLIANT / CONFORME ANFORDERUNGEN ERFÜLLT / CONFORME</i>
	
CLASSIFICAZIONE ANTISDRUCCIOLO <i>ASSESSMENT OF SLIP RESISTANCE / CLASSIFICATION ANTIGLISSE RUTSCHFESTIGKEITSKLASSECLASIFICACIÓN ANTIDESLIZANTE</i>	CONFORME <i>COMPLIANT / CONFORME ANFORDERUNGEN ERFÜLLT / CONFORME</i>
	
>36 60x120 – 60x60 – 40x60 – 30x60 – 20x60 Quartz/Golden/Smoke/Cabernet	

Piastrelle pressate a secco - Conforme alla norma EN 14411 e ISO 13006 appendice G gruppo B1-a con E ≤0,5%

















Dry pressed tiles - Compliant with standards EN 14411 and ISO 13006 annex G group B1-a with E ≤0,5% / Carreau pressé à sec - Conforme à la norme EN 14411 et ISO 13006 annexe G groupe B1-a avec E ≤0,5% / Trocken gepresste Fliesen - Erfüllen die Anforderungen der Norm en 14411 und ISO 13006 Anhang g Gruppe B1-a mit E ≤0,5% / Baldosas prensadas en seco - Conforme a las normas en 14411 e iso 13006, anexo g grupo B1-a con E ≤0,5 %

364/365

Pasta bianca









INFORMAZIONI TECNICHE

TECHNICAL FEATURES / INFORMATIONS TECHNIQUES / TECHNISCHE INFORMATIONEN / INFORMACIÓN TÉCNICA

DESCRIZIONE <i>DESCRIPTION / DESCRIPTION / BESCHREIBUNG / DESCRIPCIÓN</i>	NORME <i>REGULATION / NORME / NORM / NORMA</i>	REQUISITI PRESCRITTI <i>REQUIRED VALUES / EXIGENCES RÉGLEMENTAIRES / VORGE- SCHRIEBENE ANFORDERUNGEN / REQUISITOS ESTABLECIDOS</i>	VALORI <i>VALUES / VALEURS / WERTE / VALORES</i>	
			ELEMENTS DESIGN 50x110 3D	
			lunghezza-larghezza ±0,3% (±1,0 mm max) <i>lenght-width / longueur-largeur / Länge-Breite / longitud-ancho</i>	
			spessore ±10,0% (±0,5 mm max) <i>thickness / épaisseur / Stärke / espesor</i>	
			ortogonalità ±0,3% (±1,5 mm max) <i>rectangularity / orthogonalité / Rechtwinkligkeit / ortogonalidad</i>	
			rettilinearità ±0,3% (±0,8 mm max) <i>straightness / rectilignité / Geradlinigkeit / rectilineidad</i>	CONFORME <i>COMPLIANT / CONFORME / ANFORDERUNGEN ERFÜLLT / CONFORME</i>
	DIMENSIONI RETTIFICATO N≥15cm <i>SIZES RECTIFIED N≥15cm / FORMAT RECTIFIÉ N≥15 CM / ABMESSUNGEN NACH DEM SCHLEIFEN N≥15CM / TAMAÑO RECTIFICADO N≥15 CM</i>	UNI EN ISO 10545-2	planarità centro ±0,4% (±1,8 mm max) <i>flatness centre / planéité centre / Planarität in der Mitte / planitud centro</i>	
			planarità angolo ±0,4% (±1,8 mm max) <i>flatness edge / planéité angle / Planarität in der Ecke / planitud borde</i>	
			planarità torsione ±0,4% (±1,8 mm max) <i>flatness warpage / planéité torsion / Planarität Torsion / planitud alabeo</i>	
			qualità superficie ≥95% <i>surface quality / qualités surface / Oberflächenbeschaffenheit / cualidades superficie</i>	
	ASSORBIMENTO ACQUA <i>WATER ABSORPTION / ABSORPTION D'EAU WASSERAUFNAHME / ABSORCIÓN DE AGUA</i>	UNI EN ISO 10545-3	E_v>10%	CONFORME <i>COMPLIANT / CONFORME / ANFORDERUNGEN ERFÜLLT / CONFORME</i>
	RESISTENZA A ROTTURA SPESSORE≥7,5cm <i>BREAKING STRENGHT THICKNESS ≥7,5cm / RÉSISTANCE À LA RUPTURE ÉPAISSEUR ≥7,5 CM / BRUCHFESTIGKEIT STARKE ≥7,5CM / RESISTENCIA A LA ROTURA ESPESOR ≥7,5 CM</i>	UNI EN ISO 10545-4	R≥12 N/mm² S≥600 N	CONFORME <i>COMPLIANT / CONFORME / ANFORDERUNGEN ERFÜLLT / CONFORME</i>
	RESISTENZA SHOCK TERMICI <i>THERMAL SHOCK RESISTANCE / RÉSISTANCE AUX ÉCARTS DE TEMPÉRATURE / WIDERSTANDSFÄHIGKEIT GEGEN TEMPERATURSCHWANKUNGEN / RESISTENCIA A LOS CAMBIOS DE TEMPERATURA</i>	UNI EN ISO 10545-9	resistenza / <i>resistant / résistance / Widerständigkeit / resistencia</i>	CONFORME <i>COMPLIANT / CONFORME / ANFORDERUNGEN ERFÜLLT / CONFORME</i>
	RESISTENZA AL CAVILLO <i>CRAZING RESISTANCE / RÉSISTANCE AU TRESSAILLAGE / HAARRISSFESTIGKEIT / RESISTENCIA AL CUARTEADO</i>	UNI EN ISO 10545-11	resistenza / <i>resistant / résistance / Widerständigkeit / resistencia</i>	CONFORME <i>COMPLIANT / CONFORME / ANFORDERUNGEN ERFÜLLT / CONFORME</i>
	PICCOLE DIFFERENZE DI COLORE <i>SMALL COLOR DIFFERENCES / PETITES DIFFÉRENCES DE COULEUR / KLEINE FARBUNTERSCHIEDE / PEQUEÑAS DIFERENCIAS DE COLOR</i>	UNI EN ISO 10545-16	ΔE<0,75%	CONFORME <i>COMPLIANT / CONFORME / ANFORDERUNGEN ERFÜLLT / CONFORME</i>
	RESISTENZA CHIMICA <i>CHEMICAL RESISTANCE / RÉSISTANCE CHIMIQUE CHEMISCHE BESTÄNDIGKEIT / RESISTENCIA QUÍMICA</i>	UNI EN ISO 10545-13	resistenza acidi e alcali / <i>resistant acid and alkalis / résistance aux acides et aux alcalis / Säure- und Alkalibeständigkeit / resistencia a ácidos y álcalis</i>	CONFORME <i>COMPLIANT / CONFORME / ANFORDERUNGEN ERFÜLLT / CONFORME</i>
	RESISTENZA CHIMICA <i>CHEMICAL RESISTANCE / RÉSISTANCE CHIMIQUE CHEMISCHE BESTÄNDIGKEIT / RESISTENCIA QUÍMICA</i>	UNI EN ISO 10545-13	minimo B per prodotti chimici domestici e additivi per piscine <i>/minimum B to household chemicals and swimming pool salt / au minimum B pour les produits chimiques à usage domestique et les additifs pour piscine / Mindestens B für Haushaltschemikalien und Additive für Schwimmbadwasser / B mínimo para productos químicos de uso doméstico y aditivos para piscinas</i>	CONFORME <i>COMPLIANT / CONFORME / ANFORDERUNGEN ERFÜLLT / CONFORME</i>
	RESISTENZA ALLE MACCHIE <i>STAIN RESISTANCE / RÉSISTANCE AUX TACHES / FLECKENFESTIGKEIT / RESISTENCIA A LAS MANCHAS</i>	UNI EN ISO 10545-14	minimo classe 3 / <i>minimum class 3 / au minimum classe 3 / Mind. Klasse 3 / mínimo clase 3</i>	CLASSE 5 <i>CLASS 5 / CLASSE 5 / KLASSE 5 / CLASE 5</i>

Pasta bianca - Conforme alla norma en 14411 e iso 13006 appendice L gruppo B3 con E_v >10%









White body - Compliant with standards EN 14411 and ISO 13006 annex L group B3 with E_v >10% / Pâte blanche - Conforme à la normeEN 14411 et ISO 13006 annexe L groupe B3 avec E_v >10 % / Weißer Scherben - Erfüllt die Anforderungen der Norm EN 14411 und ISO 13006 Anhang L Gruppe B3 mit E_v >10% / Pasta bianca - Conforme a las normas en 14411 e iso 13006, anexo L grupo B3 con E_v >10 %

DESCRIZIONE DESCRIPTION / DESCRIPTION BESCHREIBUNG / DESCRIPCIÓN	NORME REGULATION / NORME / NORM / NORMA	REQUISITI PRESCRITTI REQUIRED VALUES / EXIGENCES RÉGLEMENTAIRES / VORGESCHRIEBENE ANFORDERUNGEN / REQUISITOS ESTABLECIDOS
	EN 14411 - ISO 13006	<p>lunghezza-larghezza ±0,3% (±1,0 mm max) <i>length-width / longueur-largeur / Länge-Breite / longitud-ancho</i></p> <p>spessore ±5,0% (±0,5 mm max) <i>thickness / épaisseur / Stärke / espesor</i></p> <p>ortogonalità ±0,3% (±1,5 mm max) <i>rectangularity / orthogonalité / Rechtwinkligkeit / ortogonalidad</i></p> <p>rettilinearità ±0,3% (±0,8 mm max) <i>straightness / rectilignité / Geradlinigkeit / rectilineidad</i></p> <p>planarità ±0,4% (±1,8 mm max) <i>surface flatness / planéité / Ebenflächigkeit / planaridad</i></p> <p>qualità superficie ≥95% <i>surface quality / qualités surface / Oberflächenbeschaffenheit / cualidades superficie</i></p>
DIMENSIONI RETTIFICATO SIZES RECTIFIED / FORMAT RECTIFIÉ / ABMESSUNGEN NACH DEM SCHLEIFEN / TAMAÑO RECTIFICADO	UNI EN ISO 10545-2	<p>lunghezza-larghezza ±0,6% (±2,0 mm max) <i>length-width / longueur-largeur / Länge-Breite / longitud-ancho</i></p> <p>spessore ±5,0% (±0,5 mm max) <i>thickness / épaisseur / Stärke / espesor</i></p> <p>ortogonalità ±0,5% (±2,0 mm max) <i>rectangularity / orthogonalité / Rechtwinkligkeit / ortogonalidad</i></p> <p>rettilinearità ±0,5% (±1,5 mm max) <i>straightness / rectilignité / Geradlinigkeit / rectilineidad</i></p> <p>planarità ±0,5% (±2,0 mm max) <i>surface flatness / planéité / Ebenflächigkeit / planaridad</i></p> <p>qualità superficie ≥95% <i>surface quality / qualités surface / Oberflächenbeschaffenheit / cualidades superficie</i></p>
DIMENSIONI NON RETTIFICATO SIZES NOT RECTIFIED / FORMAT NON RECTIFIÉ / ABMESSUNGEN VOR DEM SCHLEIFEN / TAMAÑO NO RECTIFICADO	UNI EN ISO 10545-2	<p>lunghezza-larghezza ±0,6% (±2,0 mm max) <i>length-width / longueur-largeur / Länge-Breite / longitud-ancho</i></p> <p>spessore ±5,0% (±0,5 mm max) <i>thickness / épaisseur / Stärke / espesor</i></p> <p>ortogonalità ±0,5% (±2,0 mm max) <i>rectangularity / orthogonalité / Rechtwinkligkeit / ortogonalidad</i></p> <p>rettilinearità ±0,5% (±1,5 mm max) <i>straightness / rectilignité / Geradlinigkeit / rectilineidad</i></p> <p>planarità ±0,5% (±2,0 mm max) <i>surface flatness / planéité / Ebenflächigkeit / planaridad</i></p> <p>qualità superficie ≥95% <i>surface quality / qualités surface / Oberflächenbeschaffenheit / cualidades superficie</i></p>
 ASSORBIMENTO ACQUA WATER ABSORPTION / ABSORPTION D'EAU / WASSERAUFNAHME / ABSORCIÓN DE AGUA	UNI EN ISO 10545-3	≤0,5%
 RESISTENZA A ROTTURA BREAKING STRENGTH / RÉSISTANCE À LA RUPTURE / BRUCHFESTIGKEIT / RESISTENCIA A LA ROTURA	UNI EN ISO 10545-4	R≥35 N/mm² S≥700 N (<7,5 mm) S≥1300 N (≥7,5 mm)
 RESISTENZA ABRASIONE PROFONDA (UGL - Matt) DEEP ABRASION RESISTANCE (UGL - Matt) / RESISTANCE À L'ABRASION PROFONDE (UGL - Matt) / TIEFENVERSCHLEISSBESTÄNDIGKEIT (UGL - Matt) / RESISTENCIA A LA ABRASIÓN PROFUNDA (UGL - Matt)	UNI EN ISO 10545-6	≤175 mm ³
 RESIST. ABRASIONE SUPERFICIALE (GL - Lappato / Silky) SURFACE ABRASION RESISTANCE (GL - Lappato / Silky) / RESIST. A L'ABRASION SUPERFICIELLE (GL - Rodé / Silky) / WIDERSTÄNDIGKEIT GEGEN OBERFLÄCHENVERSCHLEISS (GL - geklapp / silky) / RESIST. ABRASIÓN SUPERFICIAL (GL: esmaltado / Silky)	UNI EN ISO 10545-6	dichiarare un valore / declare a value / déclarer une valeur / einen Wert angeben / declarar un valor
 RESISTENZA SHOCK TERMICI THERMAL SHOCK RESISTANCE / RÉSISTANCE AUX ÉCARTS DE TEMPÉRATURE / WIDERSTANDSFÄHIGKEIT GEGEN TEMPERATURSCHWANKUNGEN / RESISTENCIA A LOS CAMBIOS DE TEMPERATURA	UNI EN ISO 10545-9	resistenza / resistant / résistance / Widerständigkeit / resistencia
 RESISTENZA AL GELO FROST RESISTANCE / RÉSISTANCE AU GEL / FROSTWIDERSTANDSFÄHIGKEIT / RESISTENCIA AL HIELO	UNI EN ISO 10545-12	resistenza / resistant / résistance / Widerständigkeit / resistencia
 RESISTENZA CHIMICA CHEMICAL RESISTANCE / RÉSISTANCE CHIMIQUE CHEMISCHE BESTÄNDIGKEIT / RESISTENCIA QUÍMICA	UNI EN ISO 10545-13	resistenza / resistant / résistance / Widerständigkeit / resistencia
 RESISTENZA ALLE MACCHIE STAIN RESISTANCE / RESISTANCE AUX TACHES / FLECKENFESTIGKEIT / RESISTENCIA A LAS MANCHAS	UNI EN ISO 10545-14	pulibile / cleanable / nettoyable / kann gereinigt werden / lavable
	DIN 51130	R
	DIN 51097	A+B+C
 CLASSIFICAZIONE ANTISDRUCCIOLO ASSESSMENT OF SLIP RESISTANCE / CLASSIFICATION ANTIGLISSE RUTSCHFESTIGKEITSKLASSECLASIFICACIÓN ANTIDESLIZANTE	B.C.R.A. (COF)	>0,40 bagnato / wet
	ANSI A137.1 2012 (DCOF)	>0,42 bagnato / wet
	BS 7976-2:2002 (UK) (Pendulum Test Value)	0-24 scivoloso / slippery / glissant / Rutschig / resbaladizo 25-35 scivolosità moderata / moderately slippery / glissance modérée / mäßige Rutschgefahr / Deslizamiento moderado >36 basso rischio scivolamento / low slipping risk / risque de glissement faible / geringe Rutschgefahr / bajo riesgo de deslizamiento

Piastrelle pressate a secco - Conforme alla norma EN 14411 e ISO 13006 appendice G gruppo B1-a con E ≤0,5%

Dry pressed tiles - Compliant with standards EN 14411 and ISO 13006 annex G group B1-a with E ≤0,5% / Carreau pressé à sec - Conforme à la norme EN 14411 et ISO 13006 annexe G groupe B1-a avec E ≤0,5% / Trocken gepresste Fliesen - Erfüllen die Anforderungen der Norm en 14411 und ISO 13006 Anhang g Gruppe B1-a mit E ≤0,5% / Baldosas prensadas en seco - Conforme a las normas en 14411 e iso 13006, anexo g grupo B1-a con E ≤0,5 %

VALORI VALUES / VALEURS WERTE / VALORES	VALORI VALUES / VALEURS WERTE / VALORES	VALORI VALUES / VALEURS WERTE / VALORES	VALORI VALUES / VALEURS WERTE / VALORES
DUNSTONE	EXTREME	LONDALE	SKYWALL
CONFORME COMPLIANT / CONFORME ANFORDERUNGEN ERFÜLLT / CONFORME	CONFORME COMPLIANT / CONFORME ANFORDERUNGEN ERFÜLLT / CONFORME	CONFORME COMPLIANT / CONFORME ANFORDERUNGEN ERFÜLLT / CONFORME	CONFORME COMPLIANT / CONFORME ANFORDERUNGEN ERFÜLLT / CONFORME
-	-	-	-
≤0,1%	≤0,1%	≤0,1%	≤0,1%
9 / 8,5 mm R≥40 N/mm² S≥1500 N	20 mm R≥45 N/mm² S≥10000 N	9 / 8,5 mm R≥40 N/mm² S≥1500 N	20 mm R≥45 N/mm² S≥10000 N
≤150 mm ³	≤150 mm ³	≤150 mm ³	≤150 mm ³
-	-	-	-
CONFORME COMPLIANT / CONFORME ANFORDERUNGEN ERFÜLLT / CONFORME	CONFORME COMPLIANT / CONFORME ANFORDERUNGEN ERFÜLLT / CONFORME	CONFORME COMPLIANT / CONFORME ANFORDERUNGEN ERFÜLLT / CONFORME	CONFORME COMPLIANT / CONFORME ANFORDERUNGEN ERFÜLLT / CONFORME
CONFORME COMPLIANT / CONFORME ANFORDERUNGEN ERFÜLLT / CONFORME	CONFORME COMPLIANT / CONFORME ANFORDERUNGEN ERFÜLLT / CONFORME	CONFORME COMPLIANT / CONFORME ANFORDERUNGEN ERFÜLLT / CONFORME	CONFORME COMPLIANT / CONFORME ANFORDERUNGEN ERFÜLLT / CONFORME
CONFORME COMPLIANT / CONFORME ANFORDERUNGEN ERFÜLLT / CONFORME	CONFORME COMPLIANT / CONFORME ANFORDERUNGEN ERFÜLLT / CONFORME	CONFORME COMPLIANT / CONFORME ANFORDERUNGEN ERFÜLLT / CONFORME	CONFORME COMPLIANT / CONFORME ANFORDERUNGEN ERFÜLLT / CONFORME
CONFORME COMPLIANT / CONFORME ANFORDERUNGEN ERFÜLLT / CONFORME	CONFORME COMPLIANT / CONFORME ANFORDERUNGEN ERFÜLLT / CONFORME	CONFORME COMPLIANT / CONFORME ANFORDERUNGEN ERFÜLLT / CONFORME	CONFORME COMPLIANT / CONFORME ANFORDERUNGEN ERFÜLLT / CONFORME
R9 60x120 - 60x60 - 30x60	R11 45x90 K2 - 60x60 K2	R9 60x120 - 60x60 - 30x60	R11 60x60 K2
A Natural R9	A+B+C Structured R11	A Natural R9	A+B+C Structured R11
CONFORME COMPLIANT / CONFORME ANFORDERUNGEN ERFÜLLT / CONFORME	CONFORME COMPLIANT / CONFORME ANFORDERUNGEN ERFÜLLT / CONFORME	CONFORME COMPLIANT / CONFORME ANFORDERUNGEN ERFÜLLT / CONFORME	CONFORME COMPLIANT / CONFORME ANFORDERUNGEN ERFÜLLT / CONFORME
CONFORME COMPLIANT / CONFORME ANFORDERUNGEN ERFÜLLT / CONFORME	CONFORME COMPLIANT / CONFORME ANFORDERUNGEN ERFÜLLT / CONFORME	CONFORME COMPLIANT / CONFORME ANFORDERUNGEN ERFÜLLT / CONFORME	CONFORME COMPLIANT / CONFORME ANFORDERUNGEN ERFÜLLT / CONFORME
-	-	-	-

DESCRIZIONE DESCRIPTION / DESCRIPTION BESCHREIBUNG / DESCRIPCIÓN	VALORI VALUES / VALEURS WERTE / VALORES	VALORI VALUES / VALEURS WERTE / VALORES
	SWISSTONE	URBAN
DIMENSIONI RETTIFICATO SIZES RECTIFIED / FORMAT RECTIFIÉ / ABMESSUNGEN NACH DEM SCHLEIFEN / TAMAÑO RECTIFICADO	CONFORME COMPLIANT / CONFORME ANFORDERUNGEN ERFÜLLT / CONFORME	CONFORME COMPLIANT / CONFORME ANFORDERUNGEN ERFÜLLT / CONFORME
DIMENSIONI NON RETTIFICATO SIZES NOT RECTIFIED / FORMAT NON RECTIFIÉ / ABMESSUNGEN VOR DEM SCHLEIFEN / TAMAÑO NO RECTIFICADO	-	-
 ASSORBIMENTO ACQUA WATER ABSORPTION / ABSORPTION D'EAU / WASSERAUFNAHME / ABSORCIÓN DE AGUA	≤0,1%	≤0,1%
 RESISTENZA A ROTTURA BREAKING STRENGTH / RÉSISTANCE À LA RUPTURE / BRUCHFESTIGKEIT / RESISTENCIA A LA ROTURA	9 / 8,5 mm R≥40 N/mm² S≥1500 N	20 mm R≥45 N/mm² S≥10000 N
 RESISTENZA ABRASIONE PROFONDA (UGL - Matt) DEEP ABRASION RESISTANCE (UGL - Matt) / RÉSISTANCE À L'ABRASION PROFONDE (UGL - Matt) / TIEFENVERSCHLEISSBESTÄNDIGKEIT (UGL - Matt) / RESISTENCIA A LA ABRASIÓN PROFUNDA (UGL - Matt)	≤150 mm ³	≤150 mm ³
 RESIST. ABRASIONE SUPERFICIALE (GL - Lappato / Silky) SURFACE ABRASION RESISTANCE (GL - Lappato / Silky) / RESIST. À L'ABRASION SUPERFICIELLE (GL - Poisé / Silky) / WIDERSTÄNDIGKEIT GEGEN OBERFLÄCHENVERSCHLEISS (GL - geläppt / silky) / RESIST. ABRASIÓN SUPERFICIAL (GL: esmaltado / Silky)	-	-
 RESISTENZA SHOCK TERMICI THERMAL SHOCK RESISTANCE / RÉSISTANCE AUX ÉCARTS DE TEMPÉRATURE / WIDERSTANDSFÄHIGKEIT GEGEN TEMPERATURSCHWANKUNGEN / RESISTENCIA A LOS CAMBIOS DE TEMPERATURA	CONFORME COMPLIANT / CONFORME ANFORDERUNGEN ERFÜLLT / CONFORME	CONFORME COMPLIANT / CONFORME ANFORDERUNGEN ERFÜLLT / CONFORME
 RESISTENZA AL GELO FROST RESISTANCE / RÉSISTANCE AU GEL / FROSTWIDERSTANDSFÄHIGKEIT / RESISTENCIA AL HIELO	CONFORME COMPLIANT / CONFORME ANFORDERUNGEN ERFÜLLT / CONFORME	CONFORME COMPLIANT / CONFORME ANFORDERUNGEN ERFÜLLT / CONFORME
 RESISTENZA CHIMICA CHEMICAL RESISTANCE / RÉSISTANCE CHIMIQUE CHEMISCHE BESTÄNDIGKEIT / RESISTENCIA QUÍMICA	CONFORME COMPLIANT / CONFORME ANFORDERUNGEN ERFÜLLT / CONFORME	CONFORME COMPLIANT / CONFORME ANFORDERUNGEN ERFÜLLT / CONFORME
 RESISTENZA ALLE MACCHIE STAIN RESISTANCE / RÉSISTANCE AUX TACHES / FLECKENFESTIGKEIT / RESISTENCIA A LAS MANCHAS	CONFORME COMPLIANT / CONFORME ANFORDERUNGEN ERFÜLLT / CONFORME	CONFORME COMPLIANT / CONFORME ANFORDERUNGEN ERFÜLLT / CONFORME
	R10 60x120 - 60x60 - 30x60 R11 60x60 K2	R10 60x60 - 30x60
	A+B Structured R10 / A+B+C Structured R11	A+B Grip R10
 CLASSIFICAZIONE ANTISDRUCCIOLO ASSESSMENT OF SLIP RESISTANCE / CLASSIFICATION ANTIGLISSE RUTSCHFESTIGKEITSKLASSE / CLASIFICACIÓN ANTIDESLIZANTE	CONFORME COMPLIANT / CONFORME ANFORDERUNGEN ERFÜLLT / CONFORME	CONFORME COMPLIANT / CONFORME ANFORDERUNGEN ERFÜLLT / CONFORME
	CONFORME COMPLIANT / CONFORME ANFORDERUNGEN ERFÜLLT / CONFORME	CONFORME COMPLIANT / CONFORME ANFORDERUNGEN ERFÜLLT / CONFORME
	>36 In test	-

VALORI VALUES / VALEURS WERTE / VALORES
WAY
-
CONFORME COMPLIANT / CONFORME ANFORDERUNGEN ERFÜLLT / CONFORME
≤0,1%
8,5 mm R≥40 N/mm² S≥1500 N
≤150 mm ³
-
CONFORME COMPLIANT / CONFORME ANFORDERUNGEN ERFÜLLT / CONFORME
CONFORME COMPLIANT / CONFORME ANFORDERUNGEN ERFÜLLT / CONFORME
CONFORME COMPLIANT / CONFORME ANFORDERUNGEN ERFÜLLT / CONFORME
CONFORME COMPLIANT / CONFORME ANFORDERUNGEN ERFÜLLT / CONFORME
R11 30x60 Not RT - 30x30 Not RT
A+B+C Structured R11
CONFORME COMPLIANT / CONFORME ANFORDERUNGEN ERFÜLLT / CONFORME
CONFORME COMPLIANT / CONFORME ANFORDERUNGEN ERFÜLLT / CONFORME
-

Piastrelle pressate a secco - Conforme alla norma EN 14411 e ISO 13006 appendice G gruppo B1-a con E ≤0,5%

Dry pressed tiles - Compliant with standards EN 14411 and ISO 13006 annex G group B1-a with E ≤0,5% / Carreau pressé à sec - Conforme à la norme EN 14411 et ISO 13006 annexe G groupe B1-a avec E ≤0,5% / Tracken gepresste Fliesen - Erfüllen die Anforderungen der Norm en 14411 und ISO 13006 Anhang G Gruppe B1-a mit E ≤0,5% / Baldosas prensadas en seco - Conforme a las normas en 14411 e iso 13006, anexo G grupo B1-a con E ≤0,5 %

CLASSIFICAZIONE NON-SLIP

ANTI-SLIP CLASSIFICATION / CLASSIFICATION NON-SLIP / NON-SLIP KLASSIFIZIERUNG / CLASIFICACIÓN NON-SLIP

COLLEZIONI COLLECTIONS COLLEKTIONEN COLECCIONES	SUPERFICIE SURFACE SURFACE OBERFLÄCHE SUPERFICIE	METODO DELLA RAMP CALZATO (DIN 51130) SHOD RAMP TEST METHODE DE RAMPE CHAUSSÉ BESCHLAGEN RAMP TEST PRUEBA DE RAMP CALZADO				METODO DELLA RAMP A PIEDI NUDI (DIN 51097) BAREFOOT RAMP TEST METHODE DE RAMPE PIEDS NUS BARFUSS RAMP TEST PRUEBA DE RAMP DESCALZO			COEFFICIENTE DI ATTRITO COF (B.C.R.A) COEFFICIENT OF FRICTION COF COEFFICIENT DE FRICTION COF REIBUNGSKOEFFIZIENT COF COEFICIENTE DE FRICCIÓN COF	COEFFICIENTE DI ATTRITO DINAMICO DCOF (ANSI A 137.1-2012) DYNAMIC COEFFICIENT OF FRICTION DCOF / COEFFICIENT DYNAMIQUE DE FRICTION DCOF / DYNAMISCHER KOEFFIZIENT DER REIBUNG DCOF / DYNAMIC COEFFICIENTE DINÁMICO DE FRICCIÓN DCOF
		R9	R10	R11	R12	A	A+B	A+B+C	> 0,40 wet	> 0,42 wet
ALPI	Structured							conforme / compliant	conforme / compliant	
ARAN	Structured							conforme / compliant	conforme / compliant	
BACK	Natural							conforme / compliant	conforme / compliant	
	Structured							conforme / compliant	conforme / compliant	
	Grip							conforme / compliant	conforme / compliant	
BEAT	Natural							conforme / compliant	conforme / compliant	
	Structured							conforme / compliant	conforme / compliant	
	Grip							conforme / compliant	conforme / compliant	
BRYSTONE	Natural							conforme / compliant	conforme / compliant	
	Structured							conforme / compliant	conforme / compliant	
CEMENTINE	Natural							conforme / compliant	conforme / compliant	
CHORUS	Natural							conforme / compliant	conforme / compliant	
	Grip							conforme / compliant	conforme / compliant	
CODE	Natural							conforme / compliant	conforme / compliant	
	Grip							conforme / compliant	conforme / compliant	
ECLECTIC	Natural							conforme / compliant	conforme / compliant	
	Lappato	-	-	-	-	-	-	-	-	
	Silky	-	-	-	-	-	-	-	-	
ELEMENTS DESIGN	Natural							conforme / compliant	conforme / compliant	
	Structured							conforme / compliant	conforme / compliant	
	Lappato	-	-	-	-	-	-	-	-	
	Glossy	-	-	-	-	-	-	-	-	
ELEMENTS LUX	3D	-	-	-	-	-	-	-	-	
	Natural							conforme / compliant	conforme / compliant	
	Lappato	-	-	-	-	-	-	-	-	
EVOKE	Natural							conforme / compliant	conforme / compliant	
	Structured							conforme / compliant	conforme / compliant	
GRANIGLIATI LINEA TECNICA	Natural							conforme / compliant	conforme / compliant	
	Grip+Struct.							conforme / compliant	conforme / compliant	
IKON	Natural							conforme / compliant	conforme / compliant	
	Grip							conforme / compliant	conforme / compliant	
INTERNO4	Natural							conforme / compliant	conforme / compliant	
	Lappato	-	-	-	-	-	-	-	-	
K-COLOR	Natural	-	-	-	-	-	-	-	-	
	Grip							conforme / compliant	conforme / compliant	
LANGHE	Structured							conforme / compliant	conforme / compliant	
MIDLAKE	Structured							conforme / compliant	conforme / compliant	
MOOV	Natural							conforme / compliant	conforme / compliant	
	Structured							conforme / compliant	conforme / compliant	
	Grip							conforme / compliant	conforme / compliant	

BS 7976-2:2002 (UK) (Pendulum Test Value) PTV 96 R10 >36 CURSORE BAGNATO SLIDER WET CURSEUR HUMIDE SCHIEBER NASS CONTROL DESLIZANTE MOJADO					
> 36					

60x120 Walnut/Grey/ Silver/Anthracite	30x120 Walnut/Grey/ Silver/Anthracite	60x60 Walnut/Grey/ Silver/Anthracite	30x60 Walnut/Grey/ Silver/Anthracite	9,7x60 Walnut/Grey/ Silver/Anthracite
--	--	---	---	--

20x120 Brown/Ivory/ Grey/Taupe/Walnut
--

60x120 White/Ivory/ Gold/Avana	60x60 White/Ivory/ Gold/Avana	30x60 White/Ivory/ Gold/Avana
-----------------------------------	----------------------------------	----------------------------------

60x120 Tobacco/Silver/ Beige/Grey/White	60x60 Tobacco/Silver/ Beige/Grey/White	30x60 Tobacco/Silver/ Beige/Grey/White
--	---	---

60x120 Ivory/Taupe/ Silver/Grey/Black	60x60 Ivory/Taupe/ Silver/Grey/Black	30x60 Ivory/Taupe/ Silver/Grey/Black
--	---	---

120x120 Grey/White/Sky	60x120 Grey/Silver/ White/Sky/Beige	30x120 Grey/Silver/ White/Sky/Beige	60x60 Grey/Silver/ White/Sky/Beige	30x60 Grey/Silver/ White/Sky/Beige	9,7x60 Grey/Silver/ White/Sky/Beige
---------------------------	--	--	---------------------------------------	---------------------------------------	--

15x15 Bra/Contemilia/ Gavi/Monforte
--

120x120 Grey/Anthracite/ Moka/Ivory	60x120 Grey/Anthracite/ Moka/Ivory	60x60 Grey/Anthracite/ Moka/Ivory	30x60 Grey/Anthracite/ Moka/Ivory
--	---------------------------------------	--------------------------------------	--------------------------------------

CLASSIFICAZIONE NON-SLIP

ANTI-SLIP CLASSIFICATION / CLASSIFICATION NON-SLIP / NON-SLIP KLASSIFIZIERUNG / CLASIFICACIÓN NON-SLIP

COLLEZIONI COLLECTIONS COLLECTIONS KOLLEKTIONEN COLECCIONES	SUPERFICIE SURFACE SURFACE OBERFLÄCHE SUPERFICIE	METODO DELLA RAMPA CALZATO (DIN 51130) SHOD RAMP TEST METHODE DE RAMPE CHAUSSÉ BESCHLAGEN RAMP TEST PRUEBA DE RAMPA CALZADO				METODO DELLA RAMPA A PIEDI NUDI (DIN 51097) BAREFOOT RAMP TEST METHODE DE RAMPE PIEDS NUS BARFUSS RAMP TEST PRUEBA DE RAMPA DESCALZO			COEFFICIENTE DI ATTRITO COF (B.C.R.A) COEFFICIENT OF FRICTION COF COEFFICIENT DE FRICTION COF REIBUNGSKOEFFIZIENT COF COEFICIENTE DE FRICCIÓN COF	COEFFICIENTE DI ATTRITO DINAMICO DCOF (ANSI A 137.1-2012) DYNAMIC COEFFICIENT OF FRICTION DCOF / COEFFICIENT DYNAMIQUE DE FRICTION DCOF / DYNAMISCHER KOEFFIZIENT DER REIBUNG DCOF / DYNAMIC COEFICIENTE DINÁMICO DE FRICCIÓN DCOF
		R9	R10	R11	R12	A	A+B	A+B+C	> 0,40 wet	> 0,42 wet
NOORD	Natural								conforme / compliant	conforme / compliant
	Grip								conforme / compliant	conforme / compliant
PERCORSI EXTRA	Natural								conforme / compliant	conforme / compliant
	Structured								conforme / compliant	conforme / compliant
PERCORSI QUARTZ	Natural								conforme / compliant	conforme / compliant
	Structured								conforme / compliant	conforme / compliant
PERCORSI SMART	Natural								conforme / compliant	conforme / compliant
	Structured								conforme / compliant	conforme / compliant
PIETRE DI KEOPE	Structured								conforme / compliant	conforme / compliant
POINT	Structured								conforme / compliant	conforme / compliant
SIGHT	Structured								conforme / compliant	conforme / compliant
SOUL	Natural								conforme / compliant	conforme / compliant
	Structured								conforme / compliant	conforme / compliant
SUITE	Natural								conforme / compliant	conforme / compliant
	Structured								conforme / compliant	conforme / compliant
	3D	-	-	-	-	-	-	-	-	-
SUNRISE	Grip								conforme / compliant	conforme / compliant

BS 7976-2:2002 (UK) (Pendulum Test Value) PTV 96 R10 >36 CURSORE BAGNATO SLIDER WET CURSEUR HUMIDE SCHIEBER NASS CONTROL DESLIZANTE MOJADO						
> 36						
120x120 Anthracite/ Grey/Taupe/Gold/White	60x120 Anthracite/Grey/ Taupe/Gold/White	30x120 Anthracite/Grey/ Taupe/Gold/White	80x80 Anthracite/Grey/ Taupe/Gold/White	60x60 Anthracite/Grey/ Taupe/Gold/White	30x60 Anthracite/Grey/ Taupe/Gold/White	9,7x60 Anthracite/Grey/ Taupe/Gold/White
60x120 Pietra di Vals/Pietra di Barge/ Pietra di Faedis		60x60 Pietra di Vals/Pietra di Barge/ Pietra di Faedis		30x60 Pietra di Vals/Pietra di Barge/ Pietra di Faedis		
60x120 Quartz/Golden/ Smoke/Cabernet						
60x60 Quartz/Golden/ Smoke/Cabernet		40x60 Quartz/Golden/ Smoke/Cabernet		30x60 Quartz/Golden/ Smoke/Cabernet		20x60 Quartz/Golden/ Smoke/Cabernet

Contract

CLASSIFICAZIONE NON-SLIP

ANTI-SLIP CLASSIFICATION / CLASSIFICATION NON-SLIP / NON-SLIP KLASSIFIZIERUNG / CLASIFICACIÓN NON-SLIP

COLLEZIONI COLLECTIONS COLLECTIONS KOLLEKTIONEN COLECCIONES	SUPERFICIE SURFACE SURFACE OBERFLÄCHE SUPERFICIE	METODO DELLA RAMPA CALZATO (DIN 51130) SHOD RAMP TEST METHODE DE RAMPE CHAUSSÉ BESCHLAGEN RAMP TEST PRUEBA DE RAMPA CALZADO				METODO DELLA RAMPA A PIEDI NUDI (DIN 51097) BAREFOOT RAMP TEST METHODE DE RAMPE PIEDS NUS BARFUSS RAMP TEST PRUEBA DE RAMPA DESCALZO			COEFFICIENTE DI ATTRITO COF (B.C.R.A) COEFFICIENT OF FRICTION COF COEFFICIENT DE FRICTION COF REIBUNGSKOEFFIZIENT COF COEFICIENTE DE FRICCIÓN COF	COEFFICIENTE DI ATTRITO DINAMICO DCOF (ANSI A 137.1-2012) DYNAMIC COEFFICIENT OF FRICTION DCOF / COEFFICIENT DYNAMIQUE DE FRICTION DCOF / DYNAMISCHER KOEFFIZIENT DER REIBUNG DCOF / DYNAMIC COEFICIENTE DINÁMICO DE FRICCIÓN DCOF
		R9	R10	R11	R12	A	A+B	A+B+C	> 0,40 wet	> 0,42 wet
DUNSTONE	Natural								conforme / compliant	conforme / compliant
EXTREME	Structured								conforme / compliant	conforme / compliant
LONDALE	Natural								conforme / compliant	conforme / compliant
SKYWALL	Structured								conforme / compliant	conforme / compliant
SWISSTONE	Structured								conforme / compliant	conforme / compliant
URBAN	Grip								conforme / compliant	conforme / compliant
WAY	Structured								conforme / compliant	conforme / compliant

BS 7976-2:2002 (UK) (Pendulum Test Value) PTV 96 R10 >36 CURSORE BAGNATO SLIDER WET CURSEUR HUMIDE SCHIEBER NASS CONTROL DESLIZANTE MOJADO						
> 36						
in test						

CERTIFICAZIONI/ CERTIFICATION /

CERTIFICATION / ZERTIFIZIERUNG / CERTIFICACIÓN

IT_

Keope è una delle aziende oggi più attente alle qualità ecologiche dell'industria ceramica. Grazie all'efficiente e moderno stabilimento produttivo, è stata nel 2004 la prima azienda ceramica che ha completato il percorso di verifica e riduzione delle proprie emissioni di CO2 e gas ad effetto serra, in ottemperanza a quanto stabilito dal protocollo di Kyoto, dando il via ad una serie di importanti iniziative volte e migliorare l'efficienza complessiva dell'Azienda.

Il consistente investimento di capitali e risorse umane non è solo finalizzato ad una produzione di elevato livello tecnologico, ma a garantire un ciclo di fabbricazione che si svolga nel pieno rispetto dell'uomo e dell'ambiente. Macchine e impianti sono dotati dei più moderni sistemi di sicurezza, la cui efficienza è verificata periodicamente. Nello stabilimento KEOPE si curano la depurazione delle emissioni gassose secondo le normative vigenti, il completo riutilizzo di acque e scarti solidi di lavorazione e la raccolta differenziata di tutti gli altri rifiuti. Presso lo stabilimento è installato inoltre un impianto di cogenerazione che limita le esigenze energetiche, garantendo un basso contenuto di emissioni nocive.

FR_

Keope est une des entreprises actuellement les plus sensibles aux qualités écologiques de l'industrie de la céramique. Grâce à l'efficacité et à la modernité de son établissement de production, en 2004 elle a été la première entreprise de céramique à compléter le parcours de vérification et réduction des émissions de CO2 et gaz à effet de serre, dans le respect du protocole de Kyoto, entamant une série d'importantes initiatives visant à améliorer l'efficacité globale de l'entreprise.

L'investissement consistant de capitaux et de ressources humaines n'a pas uniquement pour but une production technologiquement avancée, mais aussi celui de garantir un cycle de fabrication se déroulant dans le plein respect de l'homme et de l'environnement. Les machines et les installations sont équipées des systèmes de sécurité les plus modernes, dont l'efficacité est vérifiée régulièrement. Au sein de l'établissement KEOPE, on s'occupe d'éliminer les émissions gazeuses selon les normes en vigueur, de réutiliser totalement les eaux et déchets solides issus de la production et de réaliser le tri sélectif de tous les autres déchets. L'établissement comprend également une installation de cogénération limitant les exigences énergétiques et garantissant un faible contenu d'émissions nocives.

EN_

Keope is actually one of the companies with the higher attention level to the ecological characteristics in the tile industry. As a result of its efficient and modern production plant, Ceramiche Keope in 2004 has become the first ceramic tile company to have fully implemented a system to control and reduce emissions of carbon dioxide and other greenhouse gases, in compliance with the directives of the Kyoto protocol. Ceramiche Keope confirmed its commitment to an environment friendly policy, by attaining UNI ISO 14064 certification for the enforcement of the Kyoto Protocol in September 2007 and therefore becoming the first European and the world's first ceramic industry to do so.

The considerable financial and human resource investments made are not only directed to high-tech production, but also to ensure a manufacturing cycle that fully respects man and his environment. Machines and installations are equipped with the most modern safety systems that are periodically checked for efficiency. In KEOPE's factory, the purification of gaseous emissions, the complete reutilization of water, solid processing rejects and the differentiated collection of all waste material are effectuated in accordance with the standards in force. Furthermore, a cogeneration installation has been installed in the factory that limits energy needs, ensuring a low content of harmful emissions.

DE_

Keope ist heute eines der umweltbewusstesten Unternehmen der Keramikindustrie. Dank seiner effizienten und modernen Produktionsanlage hat es 2004 als erstes Keramikunternehmen den Prozess der Überprüfung und Reduzierung seiner CO2- und Treibhausgasemissionen gemäß den Bestimmungen des Kyoto-Protokolls abgeschlossen und eine Reihe wichtiger Initiativen zur Verbesserung der Gesamteffizienz des Unternehmens eingeleitet. Die erheblichen Investitionen in Kapital und Humanressourcen zielen nicht nur auf eine Produktion auf hohem technologischem Niveau ab, sondern auch auf die Sicherstellung eines Produktionszyklus, der unter voller Achtung von Mensch und Umwelt stattfindet. Maschinen und Anlagen sind mit modernsten Sicherheitssystemen ausgestattet, deren Effizienz regelmäßig überprüft wird. Im Werk von KEOPE werden gasförmige Emissionen aus den Anlagen gemäß den geltenden Vorschriften gereinigt, Wasser und feste Verarbeitungsabfälle vollständig wiederverwendet und alle anderen Abfälle getrennt gesammelt. Darüber hinaus ist im Produktionswerk ein Blockheizkraftwerk installiert, das den Energiebedarf begrenzt und einen niedrigen Schadstoffausstoß garantiert.

ES_

Keope es una de las empresas que más atención presta en la actualidad al aspecto ecológico de la industria cerámica. Gracias a sus instalaciones de producción modernas y eficaces, en 2004 se convirtió en la primera empresa cerámica en completar el proceso de verificación y reducción de las emisiones de CO2 y de gases de efecto invernadero conforme a lo estipulado en el protocolo de Kioto, a raíz del cual se pusieron en marcha una serie de iniciativas importantes dirigidas a mejorar la eficiencia general de la empresa.

La inversión permanente de capital y recursos humanos no solo está orientada a lograr una producción de alto nivel tecnológico, sino también a garantizar un ciclo de producción que se desarrolle con pleno respeto por el ser humano y el medio ambiente. Las máquinas y las instalaciones disponen de los sistemas de seguridad más modernos, cuya eficacia se comprueba periódicamente. En la planta de KEOPE se lleva a cabo la purificación de gases de escape según la normativa actualmente en vigor, además de la reutilización de aguas residuales y residuos sólidos de fabricación y la recogida diferenciada de todos los demás residuos. En la planta existe una instalación de cogeneración que limita la demanda energética, lo que se garantiza un nivel bajo de emisiones perjudiciales.

CERTIFICAZIONI DI PROCESSO/ PROCESS CERTIFICATIONS /

CERTIFICATION DE PROCESSUS / PROZESSZERTIFIZIERUNG / CERTIFICACIÓN DE PROCESO

UNI EN ISO 9001

IT_

Azienda certificata per la progettazione, produzione vendita di piastrelle ceramiche in gres fine porcellanato secondo la **norma iso 9001**.

FR_

Firme certifiée pour la conception du projet, la production et la vente de carreaux de ceramique en gres fin avec fini porcelaine selon la norme iso 9001.

EN_

Major company whose design, production and sale of fully vitrified porcelain tiles has been certified under iso 9001 standards.

DE_

Unternehmen mit zertifizierung für die entwicklung, die Produktion und den verkauf von Fliesen und Platten aus feinsteinzeug nach iso 9001.

ES_

empresa certificada para la proyectacion, produccion y venta de azulejos ceramicos de gres fino a porcelanado segun la norma iso 9001.



OHSAS 18001

(Occupational Health and Safety Assessment Series)

IT_

Ceramiche Keope ha ottenuto recentemente la Certificazione OHSAS 18001. Si tratta di uno standard per la gestione della salute e della sicurezza dei lavoratori che permette alle imprese di attuare un controllo responsabile dei rischi e aumentare costantemente la tutela e il benessere sui luoghi di lavoro, al fine di proteggere il personale da eventuali pericoli.

FR_

Ceramiche Keope a récemment obtenu la Certification OHSAS 18001. Il s'agit d'une norme de management de la santé et de la sécurité au travail, qui permet aux entreprises de mettre en place un contrôle responsable des risques et d'améliorer sans cesse la protection et le bien-être sur les lieux de travail, afin de protéger le personnel contre d'éventuels dangers.

EN_

Ceramiche Keope has been OHSAS 18001 certified recently. It is a standard for the management of the health and safety of workers that allows companies to implement responsible control of risks and constantly increase the protection and well-being in the workplace, in order to protect staff from any dangers.

DE_

Ceramiche Keope hat kürzlich die OHSAS 18001 Zertifizierung erhalten. Es handelt sich um eine Norm für das Management der Gesundheit und Sicherheit der Arbeitnehmer, die es den Unternehmen ermöglicht, eine verantwortungsvolle Kontrolle der Risiken durchzuführen und den Schutz und das Wohlbefinden am Arbeitsplatz ständig zu erhöhen und das Personal entsprechend vor Gefahren zu schützen.

ES_

Ceramiche Keope ha obtenido recientemente la Certificación OHSAS 18001. Se trata de un estándar para la gestión de la seguridad y la salud de los trabajadores que permite a las empresas implementar un control responsable de riesgos y aumentar constantemente la protección y el bienestar en el lugar de trabajo, a fin de proteger al personal de cualquier posible peligro.



CERTIFICAZIONI DI PRODOTTO/ PRODUCTS CERTIFICATION /

CERTIFICATION DE PRODUIT / PRODUKTZERTIFIZIERUNG / CERTIFICACIÓN DE PRODUCTO

DOP/CE

IT_

La marcatura CE è la certificazione di sicurezza del prodotto richiesta dall'Unione Europea ed ha lo scopo di salvaguardare la salute delle persone e i beni nelle opere di costruzione. Il nuovo Regolamento UE N. 305/2011 ha introdotto la Dichiarazione di Prestazione (DOP, Declaration of Performance) con la quale il fabbricante comunica i requisiti di sicurezza dei propri materiali. Le DoP delle collezioni di Ceramiche Keope sono disponibili all'indirizzo keope.com

FR_

Le marquage CE est la certification de sécurité du produit exigée par l'Union européenne et qui a pour but de protéger la santé des personnes et des biens dans les œuvres de construction. Le nouveau règlement UE N. 305/2011 a introduit la Déclaration de Performance (DOP, Declaration of Performance), à travers laquelle le fabricant communique les conditions de sécurité de ses matériaux. Les DoP des collections de Ceramiche Keope sont disponibles à l'adresse keope.com

EN_

The CE mark is the safety product certification required by EU and it is finalized to preserve the people's health and the goods in buildings. The new Regulation UE N. 305/2011 is valid from the first of July 2013 and the most important news is the introduction of the Declaration Of Performance (DOP) with which the supplier communicates the safety requirements concerning own materials. Find the conformity of the collections of Ceramiche Keope at keope.com

DE_

Die CE-Kennzeichnung ist die von der Europäischen Union geforderte Produktsicherheitszertifizierung und hat zum Ziel, die Gesundheit von Menschen und Gütern bei Bauarbeiten zu schützen. Mit der neuen EU-Verordnung Nr. 305/2011 wurde die Leistungserklärung (DOP) eingeführt, mit der der Hersteller die Sicherheitsanforderungen an seine Materialien kommuniziert. Die DoPs der Kollektionen von Ceramiche Keope sind unter folgender Adresse keope.com einsehbar.

ES_

La finalidad de la marca CE y de la certificación de seguridad del producto que exige la Unión Europea es preservar la salud de las personas y los bienes materiales en las obras de construcción. El nuevo Reglamento 305/2011 de la UE introduce la Declaración de prestaciones (DOP, Declaration of Performance) con la que el fabricante comunica los requisitos de seguridad de sus propios materiales. La DOP de las colecciones de Ceramiche Keope se encuentra disponible en la dirección keope.com

CCC

IT_

Il certificato cinese obbligatorio, comunemente noto come marchio CCC (China Compulsory Certificate), è un marchio di sicurezza obbligatorio per molti prodotti venduti sul mercato cinese. È diventato effettivo il 1° maggio 2002.

FR_

Le certificat chinois obligatoire, connu comme label CCC (China Compulsory Certificate) est un marquage de sécurité obligatoire pour de nombreux produits vendus sur le marché chinois. Il est devenu effectif le 1er mai 2002.

EN_

The China Compulsory Certificate mark, commonly known as a CCC Mark, is a compulsory safety mark for many imported products, sold in the Chinese market. It was implemented on May 1, 2002.

DE_

Das obligatorische chinesische Zertifikat, allgemein bekannt als das China Compulsory Certificate (CCC) Zeichen, ist ein obligatorisches Sicherheitszeichen für viele Produkte, die auf dem chinesischen Markt verkauft werden. Es ist am 1. Mai 2002 in Kraft getreten.

ES_

El certificado chino obligatorio correspondiente a la marca CCC (China Compulsory Certificate) es imprescindible como marca de seguridad en muchos productos que se venden en el mercado chino. Entró en vigor el 1 de mayo de 2002.



UPEC

IT_

Molti prodotti Keope sono testati e classificati secondo le normative UPEC, al fine di certificarne l'appropriatezza rispetto alle destinazioni d'uso. I test ai quali sono sottoposte le piastrelle presso il "Centre Scientifique du Bâtiment (CSTB)" - secondo le specifiche normative emanate dal CSTB - sono estremamente selettivi e sono volti a stabilire la resistenza e le performance dei prodotti rispetto a quattro dimensioni fondamentali: resistenza all'usura (U), alla perforazione (P), all'acqua (E) e all'aggressione chimica (C). Le schede Upec delle singole serie sono disponibili all'indirizzo keope.com/upec

FR_

De nombreux produits Keope sont testés et classés selon les normes UPEC, afin d'en certifier l'adéquation aux destinations d'utilisation. Les tests auxquels sont soumis les carreaux auprès du « Centre Scientifique du Bâtiment (CSTB) » – selon les normes spécifiques issues du CSTB – sont extrêmement stricts et visent à établir la résistance et les performances des produits selon quatre axes essentiels : résistance à l'usure (U), à la perforation (P), à l'eau (E) et à l'agression chimique (C). Les fiches Upec de chaque série sont disponibles à l'adresse keope.com/upec

SASO

IT_

Certificato di Conformità per le esportazioni verso l'Arabia Saudita. Per tutte le esportazioni verso l'Arabia Saudita è stato attuato un programma di valutazione della conformità. Tutti i prodotti richiedono un Certificato di Conformità indicato anche come SASO CoC.

FR_

Certificat de Conformité pour les exportations vers l'Arabie Saoudite. Pour toutes les exportations vers l'Arabie Saoudite, un programme d'évaluation de la conformité a été établi. Tous les produits doivent porter un Certificat de Conformité appelé SASO CoC.

EN_

Many Keope products are tested and classified according to the UPEC standards, in order to certify their appropriateness with regard to the intended uses. The tests which the tiles undergo at the "Centre Scientifique du Bâtiment (CSTB)" - in accordance with specific rules issued by CSTB - are extremely selective and are aimed at establishing the resistance and performance of the products with respect to four fundamental "dimensions": resistance to wear (U), perforation (P), water (E) and chemical attack (C). UPEC data sheets of the series are available at keope.com/upec

DE_

Viele Keope-Produkte werden nach den UPEC-Vorschriften geprüft und klassifiziert, um ihre Eignung für den vorgesehenen Einsatzzweck zu bestätigen. Die Prüfungen, denen die Fliesen im „Centre Scientifique du Bâtiment (CSTB)" - gemäß den spezifischen Vorschriften des CSTB - unterzogen werden, sind äußerst selektiv und zielen darauf ab, die Beständigkeit und Leistung der Produkte in Bezug auf vier grundlegende Dimensionen festzustellen: Verschleißfestigkeit (U), Perforation (P), Wasser (E) und chemische Beständigkeit (C). Die Upec-Datenblätter der einzelnen Serien sind unter folgender Adresse keope.com/upec einsehbar.

ES_

Las pruebas a las que se han sometido muchos de los productos Keope demuestran el cumplimiento de las normativas UPEC, que certifican su adecuación al uso previsto. Las baldosas se someten a pruebas extremadamente selectivas en el "Centre Scientifique du Bâtiment (CSTB)" según normas específicas del CSTB, que están dirigidas a establecer la resistencia y las prestaciones de los productos en cuatro aspectos fundamentales: resistencia al desgaste (U), a la perforación (P), al agua (E) y a la agresión química (C). Las fichas de la UPEC correspondientes a cada serie están disponibles en la dirección keope.com/upec



CERTIFICAZIONI DI PRODOTTO/ PRODUCTS CERTIFICATION /

CERTIFICATION DE PRODUIT / PRODUKTZERTIFIZIERUNG / CERTIFICACIÓN DE PRODUCTO

EPD

(Environmental Product Declaration)

IT_

È uno schema di certificazione volontaria di prodotto, nato in Svezia ma di valenza internazionale, inquadrato dalle norme ISO 14020 e ISO 14025.

Si tratta di una dichiarazione che permette di comunicare informazioni oggettive, confrontabili e credibili relative alla prestazione ambientale dei prodotti di Ceramiche Keope, analizzando l'impatto ambientale a partire dalla fase di estrazione delle materie prime fino alla fine del ciclo di vita ("cradle to grave").

FR_

Il s'agit d'un schéma de certification volontaire de produit, né en Suède mais à valeur internationale, encadré par les normes ISO 14020 et ISO 14025.

Il s'agit d'une déclaration permettant de communiquer des informations objectives, comparables et crédibles concernant les performances environnementales des produits de Ceramiche Keope, analysant l'impact environnemental à partir de la phase d'extraction des matières premières jusqu'à la fin de cycle de vie ("cradle to grave").

EN_

Is a voluntary certification program, created in Sweden with an international scope, based on the ISO 14020 and ISO 14025 standards.

This declaration communications objective, comparable and transparent information about the environmental performance of Keope products. It analyses the environmental impact starting from extraction of raw materials to the end of the product's life-cycle ("from the cradle to the grave").

DE_

Es ist ein freiwilliges Produktzertifizierungssystem, das seinen Ursprung in Schweden hat, aber international an Gültigkeit gewonnen hat und sich auf die Normen ISO 14020 und ISO 14025 bezieht. Es handelt sich um eine Erklärung, die es ermöglicht, objektive, vergleichbare und glaubwürdige Informationen über die Umweltleistung der Produkte von Ceramiche Keope zu vermitteln und die Umweltauswirkungen von der Phase der Rohstoffgewinnung bis zum Ende des Lebens ("cradle to grave") zu analysieren.

ES_

Se trata de un mecanismo de certificación voluntaria de productos creado en Suecia que tiene validez internacional y que se enmarca en las normas ISO 14020 e ISO 14025. Se trata de una declaración que permite comunicar información objetiva, contrastable y verosímil relacionada con las prestaciones ambientales de los productos de Ceramiche Keope. En ella se analiza la repercusión ambiental desde la fase de extracción de las materias primas hasta el final del ciclo de vida del producto ("cradle to grave").

EPD

PEF

(Product Environmental Footprint)

IT_

È un metodo basato sul life cycle assessment (LCA), impiegato al fine di calcolare la performance ambientale di un prodotto lungo il suo intero ciclo di vita. Trae origine dalla Raccomandazione 2013/179/UE della Commissione Europea, che mira ad introdurre metodologie comuni per misurare e comunicare le prestazioni ambientali nel ciclo di vita dei prodotti e delle organizzazioni. Le informazioni relative alla PEF sono fornite con l'obiettivo generale di ridurre gli impatti ambientali dei prodotti Keope, tenendo conto delle attività della catena di approvvigionamento: dall'estrazione di materie prime, alla produzione, all'uso e fine vita del prodotto.

FR_

Il s'agit d'une méthode basée sur le life cycle assessment (LCA), employé afin de calculer la performance environnementale d'un produit durant tout son cycle de vie. Il puise son origine dans la Recommandation 2013/179/CE de la Commission européenne, qui vise à introduire des méthodologies communes pour mesurer et communiquer les performances environnementales dans le cycle de vie des produits et des organisations. Les informations concernant la PEF sont fournies avec l'objectif général de réduire les impacts environnementaux des produits Keope, en tenant compte des activités de la chaîne d'approvisionnement : de l'extraction de matières premières à la production, à l'utilisation et à la fin de vie du produit.

EN_

Is a method based on life cycle assessment (LCA), and is used to calculate the environmental performance of a product during its entire life-cycle. It has been inspired by the 2013/179/EU Recommendation of the European Commission, which has focussed on implementing common methods for measuring and communicating the environmental performance in the life-cycle of a product and of an organisation. PEF-based information is provided for the general purpose of reducing environmental impact of Keope products, taking account of the entire procurement chain: extraction of raw materials, production, use, end of the product's life-cycle.

DE_

Es handelt sich um eine auf der Ökobilanz basierende Methode, mit der die Umweltleistung eines Produkts über seinen gesamten Lebenszyklus berechnet wird. Sie geht auf die Empfehlung 2013/179/EU der Europäischen Kommission zurück, die darauf abzielt, gemeinsame Methoden zur Messung und Kommunikation der Umweltleistung im Lebenszyklus von Produkten und Organisationen einzuführen. PEF-Informationen werden mit dem übergeordneten Ziel bereitgestellt, die Umweltauswirkungen von Keope-Produkten unter Berücksichtigung der Aktivitäten der Lieferkette zu verringern: von der Gewinnung der Rohstoffe über die Herstellung, Verwendung und das Ende der Lebensdauer des Produkts.

ES_

Es un método basado en el análisis del ciclo de vida (life cycle assessment, LCA) que sirve para determinar el impacto ambiental de un producto durante su ciclo de vida completo. Se basa en la Recomendación 2013/179/UE de la Comisión Europea, que está encaminada a introducir metodología común para medir y comunicar el comportamiento ambiental durante el ciclo de vida de los productos y las organizaciones. Se proporciona información relativa a PEF con el objetivo de reducir el impacto ambiental de los productos Keope teniendo en cuenta la cadena de suministro: desde la extracción de materias primas hasta la producción, el uso y el final de la vida útil del producto.

PEF

CERTIFICAZIONI DI PRODOTTO/ PRODUCTS CERTIFICATION /

CERTIFICATION DE PRODUIT / PRODUKTZERTIFIZIERUNG / CERTIFICACIÓN DE PRODUCTO

FDES

(Fiches de Déclaration Environnementale et Sanitaire)

IT_

È una certificazione specifica del mercato francese, divenuta obbligatoria nel settore delle costruzioni a decorrere dal 2017. È progettata per informare i professionisti sulle caratteristiche ambientali e sanitarie dei diversi prodotti da costruzione. Come per EPD e PEF, è un documento standardizzato che presenta i risultati delle analisi del ciclo di vita ed informazioni sulla salute di un prodotto. È un importante strumento per aiutare i professionisti nella scelta di rendere un edificio più sostenibile, con un impatto limitato sull'ambiente. Ceramiche Keope ha ottenuto questa certificazione in collaborazione con l'ente Bureau Veritas.

EN_

Is a certification applying to the French market, which became mandatory for the building sector in 2017. It has been created to inform professionals about the environmental and health-related features of the various kinds of building material. In the same manner as the EPD and the PEF, it is a standardised document that presents the results of an analysis of the life-cycle and information about the healthiness of a product. It is an important tool for helping professionals choose materials that contribute to making a building more sustainable and with a limited impact on the environment. Ceramiche Keope has obtained this certification with the cooperation of Bureau Veritas.

FR_

Il s'agit d'une certification spécifique du marché français, devenue obligatoire dans le secteur des constructions à partir de 2017. Elle est conçue pour informer les professionnels sur les caractéristiques environnementales et sanitaires des divers produits de construction. Comme pour EPD et PEF, c'est un document normalisé qui présente les résultats des analyses du cycle de vie et des informations sur la santé d'un produit. Il s'agit d'un instrument important pour aider les professionnels dans le choix de rendre un bâtiment plus durable, avec un impact limité sur l'environnement. Ceramiche Keope a obtenu cette certification en collaboration avec l'organisme Bureau Veritas.

DE_

Es handelt sich um eine spezifische Zertifizierung des französischen Marktes, die im Bausektor ab 2017 verpflichtend wurde. Es soll die Fachleute über die Umwelt- und Gesundheitsmerkmale verschiedener Bauprodukte informieren. Wie bei EPD und PEF handelt es sich um ein standardisiertes Dokument, das die Ergebnisse von Lebenszyklusanalysen und Informationen über die Gesundheit eines Produkts enthält. Es ist ein wichtiges Instrument, um Fachleuten bei der Entscheidung zu helfen, ein Gebäude nachhaltiger zu gestalten, mit begrenzten Auswirkungen auf die Umwelt. Ceramiche Keope hat diese Zertifizierung in Zusammenarbeit mit Bureau Veritas erhalten.

ES_

Es una certificación específica del mercado francés cuyo cumplimiento se hizo obligatorio para el sector de la construcción a partir del 2017. Está diseñada para informar a los profesionales de las características ambientales y sanitarias de los distintos productos de construcción. Como ocurre con EPD y PEF, se trata de un documento estandarizado que presenta los resultados de los análisis del ciclo de vida junto con información sobre la salud de un producto. Esta importante herramienta sirve de ayuda a los profesionales que optan por la sostenibilidad de un edificio con impacto limitado en el medio ambiente. Ceramiche Keope ha obtenido esta certificación en colaboración con Bureau Veritas.

FDES
VÉRIFIÉE

HPD

(Health Product Declaration)

IT_

L'open-standard di HPD è stato creato per promuovere la rendicontazione costante delle caratteristiche del prodotto e per presentare le eventuali informazioni di pericolo per la salute di prodotti e materiali da costruzione. Riconosciuto da USGBC LEED, l'Healthy Product Declaration fornisce ai clienti le informazioni necessarie per prendere decisioni di acquisto più informate. Inoltre, l'utilizzo di prodotti con la certificazione HPD aiuta i team di progetto a raggiungere i nuovi crediti LEED@v4 Materials and Resources. Le HPD forniscono informazioni sui rischi per la salute di tutti i soggetti coinvolti nella progettazione, costruzione e allestimento del progetto, e per salvaguardare la salute dell'occupante dell'edificio. I prodotti sono valutati dal produttore utilizzando il Greenscreen List Translator, strumento on-line per lo screening delle sostanze chimiche pericolose. HPD aumenta la trasparenza e la consapevolezza, assicurando che sia il contenuto che le informazioni relative alla salubrità vengano segnalate in modo coerente.

FR_

Les normes ouvertes de HPD ont été créées pour promouvoir l'information constante sur les caractéristiques du produit et pour présenter les éventuelles informations de danger pour la santé de produits et matériaux de construction. Reconnue par USGBC LEED, l'Healthy Product Declaration fournit aux clients les informations nécessaires pour prendre des décisions d'achat plus éclairées. En outre, l'utilisation de produits avec la certification HPD aide les équipes de projet à atteindre les nouveaux crédits LEED@v4 Materials and Resources. Les HPD fournissent des informations sur les risques pour la santé de tous les individus impliqués dans la conception, construction et installation du projet, et pour protéger la santé des personnes occupant l'édifice. Les produits sont évalués par le producteur en utilisant le Greenscreen List Translator, instrument en ligne pour le dépistage des substances chimiques dangereuses. L'HPD augmente la transparence et la conscience, garantissant que le contenu et les informations sur la salubrité sont signalés de manière cohérente.

EN_

An open-standard for reporting product content. Run by a voluntary, membership industry non-profit, the openstandard HPD was created to promote consistent reporting of product and material content and to produce any health hazard information for building products and materials. Recognized by USGBC LEED standard, the Health Product Declaration provides customers with the information required to make more informed purchase decisions. Additionally, using products with HPDs helps project teams achieve the new LEED@v4 Materials and Resources credit: Building product disclosure and optimization. HPDs provide information regarding health hazards to everyone involved in designing, constructing and outfitting built environments to safeguard the health of building occupant. Products are assessed by manufacturer in-house using the GreenScreen List Translator (LT), online resource to screen for hazardous Benchmark-1 chemicals. HPD increases transparency and accuracy by ensuring that both content and health information is reported consistently.

DE_

Der Open-standard von HPD wurde geschaffen, um eine kontinuierliche Berichterstattung über die Produkteigenschaften zu fördern und Informationen über Gesundheitsgefährdungen von Bauprodukten und -materialien darzustellen. Die von USGBC LEED anerkannte Healthy Product Declaration liefert den Kunden die Informationen, die sie benötigen, um fundiertere Kaufentscheidungen zu treffen. Darüber hinaus unterstützt der Einsatz von HPD-zertifizierten Produkten die Projektteams bei der Erreichung der neuen LEED@v4 Material- und Ressourcenkredite. HPDs liefern Informationen über die Gesundheitsrisiken aller an der Planung, dem Bau und der Vorbereitung des Projekts Beteiligten und zum Schutz der Gesundheit der Bewohner des Gebäudes. Die Produkte werden vom Hersteller mit Hilfe der Greenscreen List Translator, einem Online-Tool zum Screening gefährlicher Chemikalien, bewertet. HPD erhöht die Transparenz und das Bewusstsein, indem es sicherstellt, dass sowohl Inhalte als auch Gesundheitsinformationen konsistent berichtet werden.

ES_

El estándar abierto (open-standard) de HPD se ha creado para fomentar la comunicación permanente de las características del producto y presentar la información de peligrosidad para la salud de los productos y los materiales de construcción que pueda haber. La Declaración de Salud de Producto (Healthy Product Declaration, HPD) está reconocida por USGBC LEED y proporciona a los clientes los datos necesarios para tomar decisiones de compra informadas. Además, el uso de productos con certificación HPD ayuda al equipo de diseño a obtener nuevos créditos LEED@v4 en la categoría Materiales y Recursos. En la Declaración de Salud de Producto se proporciona información sobre los riesgos para la salud de todas las personas involucradas en el diseño, la construcción y la implantación del proyecto, así como para proteger la salud de los ocupantes del edificio. El fabricante analiza los productos mediante el uso de una herramienta interactiva de detección de sustancias químicas peligrosas denominada Greenscreen List Translator. La HPD fomenta la transparencia y la concienciación porque garantiza una representación coherente del contenido y de la información.



CERTIFICAZIONI DI PRODOTTO/ PRODUCTS CERTIFICATION /

CERTIFICATION DE PRODUIT / PRODUKTZERTIFIZIERUNG / CERTIFICACIÓN DE PRODUCTO

CAM

(Criteri ambientali minimi)

IT_

Sono entrati in vigore nel 2017 in Italia i nuovi CAM “Edifici”, i criteri ambientali minimi fissati per gli appalti pubblici per progettazione e lavori per la nuova costruzione, ristrutturazione e manutenzione di edifici pubblici. Le piastrelle di ceramica Keope sono in grado di offrire un importante contributo per la conformità ai criteri ambientali ai fini dell'ottenimento di prestazioni al di sopra della media di settore. La produzione di piastrelle in gres porcellanato Keope è stata verificata in accordo ai paragrafi applicabili dell'ISO 14021:2016 “Etichette e dichiarazioni ambientali - Asserzioni ambientali auto-dichiarate (Etichettatura ambientale Tipo II)” per i seguenti aspetti ambientali: consumo e uso d'acqua, emissioni in atmosfera (particolato e fluoruri), emissioni nell'acqua e recupero dei rifiuti.

EN_

The new minimum environmental criteria - CAM - “Buildings” came into force in 2017, applicable to public contracts for design and works relating to new construction, renovation and maintenance of public buildings. Keope ceramic tiles are able to make an important contribution to compliance with environmental criteria in order to achieve performance higher than the sector average. The production of Keope porcelain stoneware tiles has been assessed in accordance with the applicable paragraphs of ISO 14021:2016 “Environmental labels and declarations - Self-declared environmental claims (Type II environmental labelling)” for the following environmental aspects: water consumption and use, emissions into the atmosphere (particulate matter and fluorides), emissions into water and waste recovery.

FR_

Les nouveaux CAM pour « Constructions », à savoir les critères minimaux de protection de l'environnement applicables aux appels d'offres publics pour l'étude de projet et les travaux de réalisation de constructions neuves, de rénovation et d'entretien des bâtiments publics sont entrés en vigueur en 2017. Les carreaux de carrelage de Keope contribuent de manière importante à obtenir la conformité aux critères de protection de l'environnement, en offrant des performances au-delà de la moyenne du secteur. La production de carrelage en grès cérame Keope s'est conformée aux paragraphes applicables de l'ISO 14021:2016 « Étiquettes et déclarations environnementales auto-proclamées (Étiquetage environnemental de type II) » pour les aspects suivants de protection de l'environnement : consommation et utilisation de l'eau, émissions dans l'atmosphère (particules et fluorures), émissions dans l'eau et recyclage des déchets.

DE_

2017 sind die neuen CAM für „Gebäude“ in Kraft getreten; es handelt sich um die die Mindestumweltkriterien für öffentliche Aufträge zur Planung und zum Bau von Neubauten, Renovierungen und Instandhaltungen öffentlicher Gebäude. Keramikfliesen von Keope können einen wichtigen Beitrag zur Einhaltung von Umweltkriterien leisten, um eine überdurchschnittliche Leistung in der Branche zu erzielen. Die Herstellung von Keope Feinsteinzeugfliesen wurde in Übereinstimmung mit den anwendbaren Absätzen der Norm ISO 14021:2016 „Umweltkennzeichnungen und -deklarationen - Umweltbezogene Anbietererklärungen (Umweltkennzeichnung Typ II)“ für folgende Umweltaspekte überprüft: Wasserverbrauch und -nutzung, Emissionen in die Atmosphäre (Partikel und Fluoride), Emissionen in Wasser und Abfallverwertung.

ES_

Han entrado en vigor en 2017 los nuevos CAM “Edificios”, los criterios ambientales mínimos establecidos para la contratación pública, para el diseño y las obras de nueva construcción, reforma y mantenimiento de edificios públicos. Los azulejos de cerámica de Keope pueden contribuir de manera importante al cumplimiento de los criterios ambientales con el fin de obtener un rendimiento superior al promedio del sector. La producción de azulejos de gres porcelánico Keope se ha verificado de acuerdo con los párrafos aplicables de la ISO 14021:2016 “Etiquetas y declaraciones ambientales - Afirmaciones ambientales autodeclaradas (etiquetado ambiental tipo II)” para los siguientes aspectos ambientales: consumo y uso de agua, emisiones a la atmósfera (partículas y fluoruros), emisiones en el agua y recuperación de residuos.



LEED

(Leadership in Energy and Environmental Design)

IT_

Ceramiche Keope si propone di introdurre il sistema di certificazione indipendente LEED – Leadership in Energy and Environmental Design – i cui parametri stabiliscono precisi criteri di progettazione e realizzazione di edifici salubri, energeticamente efficienti e a impatto ambientale contenuto. La certificazione LEED si sta affermando nel mercato americano come uno dei sistemi maggiormente diffusi per la certificazione di edifici, dalla fase di progettazione fino alla gestione quotidiana. L'eccellenza ambientale richiesta da questa certificazione garantisce la salvaguardia dell'ambiente e delle risorse naturali, il miglioramento continuo delle prestazioni ambientali delle serie e dei siti produttivi di Keope e la massima attenzione per la salute dei clienti e dipendenti Keope.

EN_

Ceramiche Keope proposes to introduce the independent LEED (Leadership in Energy and Environmental Design) certification system, the parameters of which establish precise planning criteria for the realization of healthy buildings, energy-efficient and with a contained environmental impact. The LEED certification is being established on the American market as one of the most diffused systems for the certification of buildings, from the planning stage to daily management. The environmental excellence required by this certification ensures the preservation of the environment and natural resources, continuous improvement of the environmental performance of the series and the production sites of Keope and the utmost attention to the health of Keope customers and employees.

FR_

Ceramiche Keope vise à introduire le système de certification indépendant LEED – Leadership in Energy and Environmental Design – dont les paramètres définissent des critères précis de conception et réalisation d'édifices sains, efficaces du point de vue énergétique et à impact environnemental réduit. La certification LEED est en plein essor sur le marché américain, s'imposant comme un des systèmes les plus répandus pour la certification d'édifices, de la phase de conception à la gestion quotidienne. L'excellence environnementale exigée par cette certification garantit la protection de l'environnement et des ressources naturelles, l'amélioration constante des performances environnementales des séries et des sites de production de Keope et la plus grande attention pour la santé des clients et salariés Keope.

DE_

Ceramiche Keope einleitet des unabhängigen Zertifizierungssystems LEED - Leadership in Energy and Environmental Design - anstrebt, dessen Parameter präzise Kriterien für die Planung und den Bau von gesunden, energieeffizienten und umweltfreundlichen Gebäuden festlegen. Die LEED-Zertifizierung etabliert sich auf dem amerikanischen Markt als eines der am weitesten verbreiteten Systeme für die Zertifizierung von Gebäuden, von der Planungsphase bis zum täglichen Management. Die für diese Zertifizierung erforderliche Umweltqualität garantiert den Schutz der Umwelt und der natürlichen Ressourcen, die kontinuierliche Verbesserung der Umweltleistung der Serien- und Produktionsstandorte von Keope und die größte Aufmerksamkeit für die Gesundheit der Kunden und Mitarbeiter von Keope.

ES_

Ceramiche Keope está introducir el sistema de certificación independiente LEED (Leadership in Energy and Environmental Design) y cuyos parámetros establecen criterios precisos de diseño y realización de edificios saludables, energéticamente eficientes y de impacto ambiental reducido. La certificación LEED se está consolidando en el mercado americano como uno de los sistemas de mayor aceptación para la certificación de edificios, desde la fase de diseño hasta la gestión cotidiana. La excelencia ambiental que exige esta certificación garantiza la protección del ambiente y los recursos naturales, la mejora continua de los resultados ambientales de la serie de productos y las plantas de producción de Keope y la máxima atención a la salud de los clientes y los empleados de Keope.



I CREDITI LEED DEI PRODOTTI KEOPE/ LEED CREDITS OF KEOPE PRODUCTS / LES CRÉDITS LEED DES PRODUITS KEOPE / DIE LEED-KREDITE DER KEOPE-PRODUKTE / CRÉDITOS LEED DE LOS PRODUCTOS KEOPE				
ELEMENTI / ELEMENTS / ELEMENTE / ÉLÉMENTS / ELEMENTOS	REQUISITI / REQUIREMENTS / CONDITION REQUISE / ANFORDERUNGEN / REQUISITOS	PRODOTTI KEOPE / KEOPE PRODUCTS / PRODUITS KEOPE / KEOPE-PRODUKTE / PRODUCTOS DE KEOPE	CREDITI FORNITI / CREDITS THAT CAN BE OBTAINED / CRÉDITS POUVANT ÊTRE OBTENU / KREDITS, DIE SEIN KÖNNEN ERHALTEN / CREDITOS QUE PUEDEN SER OBTENIDO /	
SS: SITI SOSTENIBILI / SS: SUSTAINABLE SITES / SS : AMÉNAGEMENT ÉCOLOGIQUE DES SITES / SS: NACHHALTIGE BAUSTELLEN / SS: SITIOS SOSTENIBLES	Riduzione dell'effetto isola di calore / <i>Reduction of the</i> <i>heat island effect /</i> <i>Réduction de l'effet îlot</i> <i>de chaleur / Reduzierung</i> <i>des wärmeisolierenden</i> <i>Wirkung / Reducción del</i> <i>efecto isla térmica</i>	SRI ≥ 0,33	1 <p>L'indice di Riflettanza Solare di un materiale è un parametro funzione del rapporto fra la quantità di energia termica emessa sulla superficie e la frazione di radiazione riflessa dalla A3:E14 stessa. Il coefficiente varia tra 0 e 1 ed è influenzato dal colore: le piastrelle di colore chiaro della gamma Keope, utilizzate in spazi esterni, contribuiscono a ridurre l'effetto isola di calore / The Solar Reflectance Index of a material is a parameter that compares the quantity of heat a surface is exposed to and the heat radiation of the A3:E14 itself. The coefficient ranges from 0 to 1 and is directly related to colour: Keope range tiles with light colours, used in outdoor spaces, contribute to reducing the Heat Island Effect / L'indice de réflectance solaire d'un matériau est un paramètre fonction du rapport entre la quantité d'énergie thermique émise à la surface et la fraction de radiation réfléchi par la A3:E14 même. Le coefficient, qui varie entre 0 et 1, est influencé par la couleur : les carreaux clairs de la gamme Keope, utilisés en extérieur, contribuent à réduire l'effet îlot de chaleur / Der Sonnenreflexionsindex eines Materials ist ein Parameter, der eine Funktion des Verhältnisses zwischen der Menge der auf der Oberfläche abgestrahlten Wärmeenergie und dem Anteil der vom A3:E14 selbst reflektierten Strahlung ist. Der Koeffizient variiert zwischen 0 und 1 und wird durch die Farbe beeinflusst: Die hellen Fliesen der Serie Keope, die im Außenbereich eingesetzt werden, tragen dazu bei, den Wärmeisolationseffekt zu reduzieren / El índice de reflectancia solar del material es un parámetro que determina la relación entre la cantidad de energía térmica que produce la superficie y la fracción de la radiación reflejada por la A3:E14. Además de variar entre 0 y 1, el índice está influenciado por el color: las baldosas de color claro de la gama Keope, que se emplean en espacios exteriores, contribuyen a reducir el efecto de isla térmica.</p>	
MR: MATERIALI E RISORSE / MR: MATERIALS AND RESOURCES / MR : MATÉRIAUX ET RESSOURCES / MR: MATERIALIEN UND RESSOURCEN / MR: MATERIALES Y RECURSOS	Trasparenza e ottimizzazione dei materiali per l'edificio / <i>Transparency and</i> <i>optimisation of building</i> <i>materials / Transparence et</i> <i>optimisation des matériaux</i> <i>pour l'édifice / Transparenz</i> <i>und Optimierung von</i> <i>Baustoffen / Transparencia</i> <i>y optimización de los</i> <i>materiales del edificio</i>	Disponibilità di una EPD certificata / Availability of a certified EPD / Disponibilité d'une EPD certifiée / Verfügbarkeit einer zertifizierten EPD / Disponibilidad de un certificado EPD	1 <p>Keope dispone di una EPD certificata da un ente esterno indipendente / Keope has obtained an EPD certified by an external and independent body / Keope dispose d'une EPD certifiée par un organisme externe indépendant / Keope hat von einer externen und unabhängigen Stelle ein zertifiziertes EPD verfügt / Keope dispone de un certificado EPD expedido por un organismo externo independiente</p>	
		Disponibilità di una EPD multi attributo / Availability of a EPD multi attribute / Disponibilité d'une EPD multi attribut / Verfügbarkeit einer EPD Multi-Attribut / Disponibilidad de una EPD multi atributo	1 <p>Ceramiche Keope dispone di una EPD che mostra, per almeno 3 indicatori, una riduzione dell'impatto al di sotto della media del settore / Keope has an EPD that shows, for at least 3 indicators, a reduction of the impact below the average represented by the EPD Confindustria Cer / L'EPD de Ceramiche Keope montre, pour au moins 3 indicateurs, une réduction de l'impact inférieure à la moyenne représentée par l'EPD Confindustria Cer / Keope verfügt über eine EPD, die für mindestens 3 Indikatoren eine Verringerung der Auswirkungen gegenüber dem Durchschnitt der EPD Confindustria Cer anzeigt / Keope tiene una EPD que muestra, para al menos 3 indicadores, una reducción en el impacto por debajo del promedio representado por la EPD Confindustria Cer</p>	
		Criteri di estrazione responsabile / Responsible extraction criteria / Critères d'extraction responsable / Kriterien für einen verantwortungsvollen Abbau / Criterios de extracción responsable	1 <p>Le materie prime utilizzate per la produzione delle piastrelle Keope dispongono di informazioni riguardo al luogo di provenienza e di estrazione e all'impegno nella riduzione dell'impatto sull'ambiente. La presenza di tali informazioni è stata attestata dall'ente di certificazione DNV - Det Norske Veritas / For all raw materials used for the production of its tiles, Keope can provide information relating to origin, extraction and commitment to reduction of environmental impact. The existence of this information has been certified by DNV - Det Norske Veritas / Les matières premières utilisées pour la production des carreaux Keope disposent d'informations concernant le lieu de provenance et d'extraction et l'engagement à réduire l'impact sur l'environnement. La présence de ces informations a été attestée par l'organisme de certification DNV - Det Norske Veritas / Die für die Herstellung der Keope-Fliesen verwendeten Rohstoffe enthalten Informationen über den Herkunfts- und Abbauport und die Verpflichtung, die Auswirkungen auf die Umwelt zu reduzieren. Diese Informationen wurden von der Zertifizierungsstelle DNV bescheinigt - Det Norske Veritas / Las materias primas empleadas en la fabricación de las baldosas Keope disponen de información sobre el lugar de procedencia y extracción de la materia prima y sobre el compromiso con la reducción del impacto ambiental. El organismo de certificación DNV ha constatado la presencia de esta información - Det Norske Veritas</p>	
		Contenuto di materiale riciclato / Recycled Content / Teneur en matériau recyclé / Gehalt an Recyclingmaterial / Contenido de material reciclado	LEED COMPLIANT	max 1 <p>Prodotto contenente materiale riciclato nell'impasto / The body containing recycled material / Produit contenant des matériaux recyclés dans la pâte / Produkt enthalten recyceltes Material in der Masse / Producto contiene pasta de material reciclado</p>
		Ingredienti dei materiali / Material ingredients / Ingrédients des matériaux / Inhaltsstoffe der Materialien / Ingredientes de los materiales	Disponibilità di una HPD / Availability of a HPD / Disponibilité d'une HPD / Verfügbarkeit einer HPD / Disponibilidad de un HPD	1 <p>Per i prodotti Keope è disponibile una HPD, un report compilato secondo lo standard HPD / A HPD is available for Keope products. This is a report drafted in accordance to the HPD Standard / Pour les produits Keope, une HPD est disponible : c'est un rapport rempli selon les normes HPD / Für Keope Produkte gibt es eine HPD, einen vollständigen Bericht, der nach dem HPD-Standard erstellt wurde / Los productos Keope tienen disponible una declaración de salud de producto; se trata de un informe redactado según el estándar HPD</p>
		Mappatura degli ingredienti ai sensi della normativa REACH / Mapping of ingredients in compliance with the REACH standard / Représentation cartographique des ingrédients selon les normes REACH / Inhaltsstoffabbildung gemäß den REACH- Vorschriften / Catalogación de los ingredientes con arreglo a la normativa REACH	1 <p>Keope dispone della mappatura della composizione dei propri prodotti, per la cui realizzazione non vengono utilizzate sostanze presente nella REACH list o nella REACH candidate list per le sostanze estremamente preoccupanti (VHC) / Keope has mapped the composition of its products, for the manufacturing of which are not used any of the substances included in the REACH list and in the REACH candidate list for very high concern substances (VHC) / Keope dispose de la représentation cartographique de la composition de ses produits, pour la réalisation de laquelle les substances présentes dans la liste REACH ou dans la liste de candidats REACH ne sont pas utilisées pour les substances extrêmement préoccupantes (VHC) / Alle unsere Grundstoffe/Materialien zur Herstellung der Keope Produkte sind in keiner REACH - Liste zu finden und somit unbedenklich in der Anwendung und in der Verarbeitung / Keope dispone de una descripción de la composición de sus productos para la realización de qué sustancias presentes en la lista REACH o en la lista de candidatos REACH no se utilizan para sustancias extremadamente preocupantes (VHC)</p>	
IEQ (QUALITÀ AMB. INTERNA) / IEQ (INDOOR ENV. QUALITY) / IEQ (QUALITÉ ENV. DE L'AIR INTÉRIEUR) / IEQ (QUALITAT DES INNENRAUMKLIMAS) / IEQ (CALIDAD AMB. INTERIOR)	Materiali basso emissivi / Low emission materials / Matériaux faible émissivité / Emissionsarme Materialien / Materiales de bajas emisiones	Assenza di Composti Organici Volatili (VOC) / No Volatile Organic Compounds (VOC) /Absence de Composés Organiques Volatiles (VOC) / Keine flüchtigen organischen Verbindungen (VOCs) / Ausencia de compuestos orgánicos volátiles (COV)	1 <p>I prodotti Keope non rilasciano alcuna sostanza organica volatile nell'ambiente / Keope products do not release volatile organic substances (VOC - volatile organic compounds) in the environment / Les produits Keope n'émettent aucune substance organique volatile dans l'environnement (VOC - volatile organic compounds) / Keope Produkte setzen keine flüchtigen organischen Verbindungen (VOCs) in die Umwelt frei / Los productos Keope no liberan ninguna sustancia orgánica volátil (COV) en el ambiente</p>	
CREDITI LEED TOTALI FORNITI / TOTAL LEED CREDITS OBTAINED / TOTAL CRÉDITS LEED FOURNIS / PRODUKTEN ENTSTEHENDE LEED-KREDITE TOTALEN / CRÉDITOS LEED TOTAL			8	

* [Certificazioni disponibili su keope.com](#) / [Certifications available on keope.com](#) / [Certificacions disponibles sur keope.com](#) / [Zertifizierungen verfügbar unter keope.com](#) / [Certificaciones disponibles en keope.com](#)

[Certificazioni disponibili su keope.com](#) / [Certifications available on keope.com](#) / [Certificacions disponibles sur keope.com](#) / [Zertifizierungen verfügbar unter keope.com](#) / [Certificaciones disponibles en keope.com](#)

LEED Leadership in energy and environmental Design Recycled material content Keope product		
COLLEZIONE COLLECTIONS / COLLECTIONS / KOLLEKTIONEN / COLECCIONES	COLORE COLOURS / COULEURS / FARBE / COLORES	%MATERIALE DI SCARTO PRE-CONSUMER %PRE-CONSUMER WASTE MATERIAL / % DÉCHETS AVANT-CONSOMMATION / % VORVERBRAUCHER-ABFALLMATERIAL / % DE MATERIAL DE DESECHO PRE-CONSUMO
Aran	ARAN ANTHRACITE	≥ 20
Back	BACK ANTHRACITE	≥ 20
Back	BACK GREY	≥ 20
Beat	BEAT TAUPE	≥ 20
Chorus	CHORUS TOBACCO	≥ 20
Code	CODE ANTHRACITE	≥ 20
Elements Design	ELEMENTS DESIGN BLACK	≥ 20
Elements Design	ELEMENTS DESIGN GREY	≥ 20
Elements Lux	ELEMENTS LUX EMPERADOR	≥ 20
Elements Lux	ELEMENTS LUX PORT LAURENT	≥ 20
Granigliati	BARDIGLIO	≥ 10
Granigliati	PARIO	≥ 10
Ikon	IKON GREY	≥ 20
Midlake	ARDESIA	≥ 20
Midlake	PORFIDO	≥ 20
Midlake	QUARTZGREY	≥ 20
Moov	MOOV ANTHRACITE	≥ 20
Moov	MOOV MOKA	≥ 20
Percorsi Extra	PIETRA DI COMBE	≥ 10
Percorsi Extra	PIETRA DI FAEDIS	≥ 10
Percorsi Quartz	PIETRA QUARTZ BLACK	≥ 10
Percorsi Smart	PIETRA DI LAVIS	≥ 20
Pietre di Keope	BASALTO	≥ 20
Sight	SIGHT ANTHRACITE	≥ 20
Soul	SOUL GREY	≥ 20
Soul	SOUL WALNUT	≥ 20
Suite	SUITE ANTHRACITE	≥ 20
Suite	SUITE TAUPE	≥ 10
Sunrise	CABERNET	≥ 20
Sunrise	COFFEE	≥ 10
Dunstone - Keope Contract	DUNSTONE BEIGE	≥ 20
Dunstone - Keope Contract	DUNSTONE GREY	≥ 20
Extreme - Keope Contract	EXTREME ANTHRACITE	≥ 20
Londale - Keope Contract	LONDALE SILVER	≥ 20
Londale - Keope Contract	LONDALE GREY	≥ 20
Urban - Keope Contract	URBAN ANTHRACITE	≥ 20
Urban - Keope Contract	URBAN GREY	≥ 20

[Certificazione disponibile su keope.com](#) / [Certification available on keope.com](#) / [Certification disponible sur keope.com](#) / [Zertifizierung verfügbar unter keope.com](#) / [Certificación disponible en keope.com](#)

POSA E MANUTENZIONE/LAYING AND MAINTENANCE

POSE ET D'ENTRETIEN / VERLEGUNG UND PFLEGE / COLOCACIÒN Y MANTENIMIENTO

<p>EN_</p> <p>POSA IN OPERA</p>	<p>IT_</p> <p>POSA IN OPERA</p>	<p>FR_</p> <p>POSE</p>	<p>DE_</p> <p>POSE</p>	<p>ES_</p> <p>POSA EN OPERA</p>
--	--	-------------------------------	-------------------------------	--

IT_
GRES FINE PORCELLANATO KEOPE:
descrizioni di capitolato

1) Caratteristiche merceologiche e di processo
Le piastrelle ed i pezzi speciali in gres fine porcellanato KEOPE sono ottenute da materie prime di elevata qualità, argille pregiate con l'aggiunta di feldspati e caolini, che vengono atomizzate e pressate a secco alla pressione specifica di 450 Kg/cm2 quindi cotte in cicli termici alla temperatura di 1250 °C. Il materiale risulta costituito da un impasto unico, compatto, ingelivo, inassorbente e resistente agli attacchi chimici e fisici.

2) Conformità alle norme
Normativa di riferimento : **UNI EN 14411 e ISO 13006** (vedi tabella caratteristiche tecniche)

La conformità alla norma ed il mantenimento di tali caratteristiche è garantito dal Sistema di Gestione della Qualità attivato da Ceramiche Keope e certificato secondo la norma UNI EN ISO 9001.

<p>EN_</p> <p>DESCRIZIONE DI CAPITOLO</p>	<p>IT_</p> <p>DESCRIZIONE DI CAPITOLO</p>	<p>FR_</p> <p>GRES CERAME FIN KEOPE : <i>cahier des charges</i></p>	<p>DE_</p> <p>FEINSTEINZEUG KEOPE: <i>Produktbeschreibung</i></p>	<p>ES_</p> <p>GRES FINO PORCELÁNICO KEOPE: especificaciones</p>
--	--	--	---	---

1) Caractéristiques du produit et du procédé de fabrication
Les carreaux et les pièces spéciales en grès cérame fin KEOPE sont fabriqués à partir de matières premières exceptionnelles, argiles de grande qualité avec ajout de feldspaths et kaolins, atomisées et pressées à sec à 450 kg/cm2. Elles sont ensuite cuites en cycles thermiques à 1 250°C. Le matériau est ainsi constitué d'une pâte unique, compacte, ingélive, imperméable et résistante aux agents chimiques et physiques.

2) Conformité aux normes
Réglementation de référence : **UNI EN 14411 ET ISO 13006** (voir tableau caractéristiques techniques)

La conformité à cette norme et le maintien de ces caractéristiques sont garantis par le Système de Gestion de la Qualité mis en place par Ceramiche Keope et certifié conformément à la norme UNI EN ISO 9001..

EN_
*KEOPE FINE PORCELAIN STONEWARE:
specifcations*

1) Product and process features
KEOPE tiles and special trims in fine porcelain stoneware are made from prime quality raw materials, exclusive clays with the addition of feldspars and kaolins, which are atomised and dry-pressed at a specific pressure of 450 Kg/cm2. They are then fired in heat cycles at 1250 °C. The result is a single body, consistent, frost-proof, impervious material that is resistant to chemical and physical agents.

2) Compliance with standards
*Reference standard: **UNI EN 14411 AND ISO 13006** (see technical characteristics table)*

Compliance with the standard and the preservation of the specified characteristics are guaranteed by the Quality Management System implemented by Ceramiche Keope and certified in accordance with UNI EN ISO 9001 standards.

<p>EN_</p> <p>DESCRIZIONE DI CAPITOLO</p>	<p>IT_</p> <p>DESCRIZIONE DI CAPITOLO</p>	<p>FR_</p> <p>GRES CERAME FIN KEOPE : <i>cahier des charges</i></p>	<p>DE_</p> <p>FEINSTEINZEUG KEOPE: <i>Produktbeschreibung</i></p>	<p>ES_</p> <p>GRES FINO PORCELÁNICO KEOPE: especificaciones</p>
--	--	--	---	---

1) Produkt- und Prozesseigenschaften
Die Fliesen und Formteile aus Feinsteinzeug von KEOPE werden aus Rohstoffen sehr hoher Qualität hergestellt, hochwertigen Tone mit Zusatz von Feldspaten und Kaolinen, die sprühgetrocknet und mit einem spezifischen Druck von 450 Kg/cm2 trockengepresst und daraufhin in Wärmezyklen bei einer Temperatur von 1250° C gebrannt werden. Das Material besteht aus einer einheitlichen Masse und ist kompakt, frostbeständig, wasserabweisend sowie beständig gegen chemische und physikalische Einwirkungen.

2) Konformität mit den Normen
*Referenznorm: **UNI EN 14411 - ISO 13006** (siehe Tabelle "Technische Daten")*

Die Konformität mit der Norm und die Erhaltung dieser Eigenschaften wird vom Qualitätsmanagementsystem von Ceramiche Keope garantiert und nach UNI EN ISO 9001 zertifiziert.

<p>EN_</p> <p>DESCRIZIONE DI CAPITOLO</p>	<p>IT_</p> <p>DESCRIZIONE DI CAPITOLO</p>	<p>FR_</p> <p>GRES CERAME FIN KEOPE : <i>cahier des charges</i></p>	<p>DE_</p> <p>FEINSTEINZEUG KEOPE: <i>Produktbeschreibung</i></p>	<p>ES_</p> <p>GRES FINO PORCELÁNICO KEOPE: especificaciones</p>
--	--	--	---	---

1)Características del producto y el proceso
Las baldosas, los azulejos y las piezas especiales de gres fino porcelánico KEOPE se obtienen a partir de materias primas excelentes, arcillas de gran calidad con adición de feldspatos y caolines, que son atomizadas y prensadas en seco a una presión específica de 450 Kg/cm2, siendo luego cocidas en ciclos térmicos a una temperatura de 1250°C. El material queda constituido por una pasta única, compacta, resistente a la helada, impermeable y resistente a los agentes químicos y físicos.

2) Cumplimiento de las normas
*Normativa de referencia: **UNI EN 14411 Y ISO 13006** (véase tabla de características técnicas)*

El cumplimiento de la norma y el mantenimiento de dichas características están garantizados por el Sistema de Gestión de la Calidad implementado por Ceramiche Keope y certificado de acuerdo con la norma UNI EN ISO 9001.

IT_
POSA IN OPERA
Al ricevimento del materiale, dopo aver controllato la corrispondenza tra i documenti di consegna e la merce e comunque prima della posa in opera, è importante

verificare accuratamente che il tono, il calibro e la scelta del materiale siano conformi. È inoltre necessario verificare che il materiale sia esente da vizi palesi (così come definiti dalle condizioni generali di vendita e dalla tabella 2 del presente manuale) poiché non potranno essere accettati reclami su materiale già posato i cui difetti fossero visibili prima della installazione. Premesso che la stonalizzazione è una caratteristica propria dei prodotti ceramici si richiede la verifica del valore V-shade delle piastrelle che si dovranno installare. Per ottenere comunque il miglior risultato estetico possibile, posare il materiale attingendo i pezzi da più scatole, in modo da ottenere una miscelazione ottimale. Per prodotti venati, come per le pietre naturali, si raccomanda di disporre la venatura delle lastre in modo da ottenere il migliore effetto estetico e cromatico. Il committente finale dovrà assicurare, per quanto di sua pertinenza, condizioni microclimatiche e di illuminazione tali da assicurare la possibilità per il posatore di condurre le operazioni di installazione in modo affidabile, controllando pertanto i materiali e l'opera in corso di realizzazione, come prescritto in precedenza.

<p>EN_</p> <p>DESCRIZIONE DI CAPITOLO</p>	<p>IT_</p> <p>DESCRIZIONE DI CAPITOLO</p>	<p>FR_</p> <p>POSE</p>	<p>DE_</p> <p>VERLEGUNG VOR ORT</p>	<p>ES_</p> <p>POSA EN OPERA</p>
--	--	-------------------------------	--	--

Au moment de la réception du matériau, après avoir contrôlé la correspondance entre les documents de livraison et la marchandise et dans tous les cas avant la pose, il est important de vérifier avec minutie que le ton, le calibre et le choix du matériau sont conformes. En outre, il est nécessaire de vérifier que le matériau est exempt de vices apparents (définis par les conditions générales de vente et par le tableau 2 du présent manuel) dans la mesure où aucune réclamation concernant un matériau déjà posé, dont les vices étaient visibles avant l'installation, ne pourra être acceptée. En partant du principe que le dénuançage est une caractéristique propre aux produits céramiques, il est demandé de vérifier la valeur V-SHADE des carreaux qui devront être installés. Afin d'obtenir le meilleur résultat esthétique possible, il faut poser le matériau en prenant des carreaux provenant de boîtes différentes de manière à obtenir un mélange parfait. Pour les produits à veinures, comme les pierres naturelles, il est recommandé de disposer la veinure des plaques de manière à obtenir le plus bel effet esthétique et chromatique. Le client final devra garantir, dans la mesure du possible, des conditions microclimatiques et d'éclairage permettant au poseur de conduire les opérations d'installation de manière fiable, en contrôlant, par conséquent, les matériaux et l'ouvrage en cours de réalisation, comme indiqué précédemment.

EN_
LAYING
When you receive the material ordered, after having

checked that the goods delivered correspond to the shipping documents, and in any case before laying, it is important to check carefully that the tone, gauge and grade of material match your order. It is also necessary to check that the material presents no visible defects (as defined by the general terms of sale and by table 2 of this manual), as no complaints will be accepted once the material has been laid, if such defects were visible beforehand. As the shading is a characteristic of ceramic products, we request that you check the value V- SHADE of the tiles you wish to fit. To obtain the best aesthetic result possible, the material should be laid using tiles from different boxes and thus obtain a varied mixture. For products with vein markings, as with natural stone effect tiles, we recommend arranging the vein markings of the slabs in such a way that the best aesthetic and chromatic effect is obtained.

The end customer must assure that the environmental and lighting conditions for which he is responsible are suitable to allow the tile fitter to carry out his work in a reliable manner. He must therefore check the materials and the tile-laying operation, as described above.

<p>EN_</p> <p>DESCRIZIONE DI CAPITOLO</p>	<p>IT_</p> <p>DESCRIZIONE DI CAPITOLO</p>	<p>FR_</p> <p>POSE</p>	<p>DE_</p> <p>VERLEGUNG VOR ORT</p>	<p>ES_</p> <p>POSA EN OPERA</p>
--	--	-------------------------------	--	--

DE_
VERLEGUNG VOR ORT
Nach Erhalt des Materials und nach Prüfung der Übereinstimmung der Lieferpapiere mit der Ware, auf jeden Fall aber vor der Verlegung, muss sorgfältig geprüft werden, ob Farbton und Werkmaß übereinstimmen und es sich um das bestellte Material (Sortierung) handelt. Es muss auch überprüft werden, dass das Material frei von offensichtlichen Mängeln ist (wie in den allgemeinen Geschäftsbedingungen und in Tabelle 2 dieses Handbuchs definiert), da keine Ansprüche auf bereits verlegtes Material geltend gemacht werden können, dessen Mängel vor der Verlegung bereits sichtbar waren. Da Farbabweichungen ein Merkmal von keramischen Produkten sind, ist eine Überprüfung des V- SHADE-Wertes der zu verlegenden Fliesen erforderlich. Um das bestmögliche ästhetische Ergebnis zu erzielen, verlegen Sie das Material am besten so, dass Fliesen abwechselnd aus mehreren Kästen entnommen werden, um eine optimale Durchmischung zu erzielen. Bei Produkten mit Äderungen der Platten so anzuordnen, dass die beste ästhetische und farbliche Wirkung erzielt wird. Der Auftraggeber hat, soweit möglich, für die mikroklimatischen Bedingungen und die entsprechenden Lichtverhältnisse zu sorgen, die es dem Fliesenleger ermöglichen, die Verlegearbeiten zuverlässig durchzuführen und dabei die Materialien und die laufenden Arbeiten, wie zuvor vorgeschrieben, zu kontrollieren.

ES_
COLOCACIÓN

Al recibir el material, después de controlar que la mercancía corresponda con los documentos de entrega (albarán), y siempre antes de colocarlo, es importante comprobar minuciosamente que el tono, el calibre y la elección del material sean conformes. También es necesario comprobar que el material no tenga vicios evidentes (definidos en las condiciones generales de venta y en la tabla 2 de este manual) ya que no podrán aceptarse reclamaciones sobre el material ya colocado cuyos defectos hayan sido visibles antes de la instalación. Dado que la destonalización es una característica de los productos cerámicos, es necesario comprobar el valor V-SHADE de las cerámicas que se deberán colocar. Para obtener el mejor resultado estético posible, coloque el material alternando las piezas de varias cajas para obtener una composición ideal.Para los productos veteados, al igual que para las piedras naturales, se recomienda distribuir el veteado de las placas de manera de obtener el mejor efecto estético y cromatico. El cliente final deberá garantizar, dentro de su competencia, condiciones microclimáticas y de iluminación que aseguren que el colocador tenga la posibilidad de realizar las operaciones de colocación de manera fiable, controlando los materiales y el trabajo que está realizando, de acuerdo con lo prescrito anteriormente.

IT_

Si consiglia di posare a colla con l'utilizzo di collanti specifici ad elevate prestazioni. Si ricorda che, al momento della posa, il sottofondo deve essere stabile, asciutto e maturo. Comunque è necessario seguire le istruzioni dei produttori dei materiali per sottofondi e collanti specifici utilizzati. Gli adesivi cementizi devono essere applicati a temperatura ambiente, ed in genere compresa tra +5° C e +30/35° C. I collanti più adatti alla posa dei materiali a marchio Ceramiche Keope, si possono identificare sulla base della Normativa Europea attualmente in vigore EN12004. Durante la posa è necessario non segnare il materiale sulla superficie di utilizzo con matite (grafite) o pennarelli indelebili, in particolar modo sui prodotti levigati. Pur non essendo necessario bagnare le piastrelle prima della posa, nel caso il retro della piastrella si presenti molto polveroso è comunque consigliabile un rapido lavaggio in acqua pulita. Nel periodo compreso tra la conclusione della posa e la consegna al committente finale, la piastrellatura ceramica dovrà essere mantenuta pulita e libera da cemento, sabbia, malta e da qualsiasi altro materiale che possa causare macchie e/o fenomeni di abrasione meccanica superficiale.

È necessario proteggere la posa da danni o contaminazioni potenzialmente apportate a seguito di una prevedibile frequentazione di altri operatori quali imbianchini, elettricisti, falegnami etc. Per la posa “a correre” si raccomanda di sfalsare le piastrelle al massimo di 20 cm. Per i materiali rettificati la fuga minima prescritta è di 2 mm (questo tipo di posa consente una maggior presa del fugante sui fianchi delle lastre, un maggior assorbimento di eventuali movimenti del sottofondo ed una compensazione delle lastre). Per quelli non rettificati si prescrive una fuga di almeno 5 mm. Ceramiche Keope non accetta contestazioni per posa di materiale rettificato con fughe inferiori ai 2mm.I prodotti in gres porcellanato Ceramiche Keope, pur essendo materiali molto resistenti, possono essere sagomati (per realizzazioni di top, scale ..), perforati per l’installazione di impianti tecnico-sanitari, utilizzando appositi dischi diamantati ed attrezzature idonee.

AVVERTENZA:

Ceramiche Keope a materiale già posato:

- non accetta contestazioni dovuti a vizi palesi, così come definiti nella tabella 2 del presente manuale.
- non risponde sulla qualita' dell'opera piastrellata ma solamente sulle caratteristiche del materiale fornito.

È bene conservare al termine della posa, alcune piastrelle di scorta per eventuali riparazioni o anche per disporre di un campione rappresentativo del materiale in caso di contestazione.

EN_

We recommend that the tiles are glued to the substrate using specific, high-performance adhesives. Please remember that the substrate must be stable, dry and properly prepared for laying. It is necessary in any case to follow the instructions provided by the manufacturers of substrates and the specific adhesives used. Cement-based adhesives must be applied at room temperature, generally between +5° and 30/35° C. The most suitable adhesives for the laying of Ceramiche Keope materials should be labelled according to the currently valid European Standard, EN12004. When laying the material, no marks should be made on the surface with pencils (graphite) or permanent markers, particularly on polished surfaces. Although it is not necessary to dampen the tiles before laying, if the tiles are very dusty, it is advisable to rinse quickly in clean water. In the period after the surfaces have been tiled until they are handed over the end customer, the ceramic tiles must be kept clean and free of cement, sand, mortar and any other material that might cause stains and/or mechanical surface abrasion.

The finished surfaces must be protected from potential damage or contaminations owing to the foreseeable presence of other tradesman such as painters and decorators, electricians, carpenters etc. For continuous surfaces we recommend staggered layouts, with a distance between edges of no more than 20 cm. For rectified materials, the minimum joint prescribed is 2 mm (this method allows the grout to have a better grip on the sides of the slabs, greater absorption of any movements of the substrate and consequently of the slabs themselves). For non-rectified materials the minimum joint prescribed is 5 mm. Ceramiche Keope will not accept any complaints for rectified tiles that have been laid leaving joints of less than 2 mm. Although products in Ceramiche Keope porcelain stoneware are highly resistant materials, they can be shaped (to create worktops, stairs, ...) and drilled to fit around pipes and other fittings etc, using purpose-built diamond abrasive discs and other suitable equipment.

WARNING:

For material that has already been laid, Ceramiche Keope:

- does not accept any complaints for visible defects, as defined in table 2 of this manual*
- does not accept liability for the quality of the tiled surface but only for the characteristics of the material supplied.*

Once the material has been laid, it is wise to keep aside a few tiles for possible future repairs or to have a sample of the material in the event of complaints.

FR_

Il est conseillé de poser avec de la colle en utilisant des adhésifs spécifiques à hautes prestations. Il est rappelé que, au moment de la pose, la sous-couche doit être stable, sèche et adaptée. Il est dans tous les cas nécessaire de suivre les instructions des fabricants des matériaux pour les sous-couches et les adhésifs cimentaires spécifiques utilisés. Les adhésifs cimentaires doivent être appliqués à une température ambiante, généralement entre +5° C et + 30/35° C. Les adhésifs les plus adaptés à la pose des matériaux de la marque Ceramiche Keope peuvent être identifiés à partir de la Norme Européenne actuellement en vigueur EN12004. Durant la pose, il est nécessaire de ne pas écrire sur la surface d'utilisation du matériau à l'aide de crayons (graphites) ou de marqueurs indélébiles, notamment sur celle des produits polis. Bien qu'il ne soit pas nécessaire de mouiller les carreaux avant la pose, il est toutefois conseillé de laver rapidement avec de l'eau propre le dos du carreau si celui-ci est poussiéreux. Dans la période comprise entre la conclusion de la pose et la livraison au client final, le carrelage céramique devra être maintenu propre et dépourvu de ciment, sable, mortier et de tout autre matériau pouvant entraîner des taches et/ou des phénomènes d'abrasion mécanique superficielle.

Il est nécessaire de protéger la pose vis-à-vis des dommages ou des contaminations provenant, éventuellement, d'un passage prévisible d'autres ouvriers tels que des peintres en bâtiment, des électriciens, des menuisiers, etc. Pour la pose dite à fond perdu, il est recommandé de décaler les carreaux de 20 cm au maximum. Pour les matériaux rectifiés, le joint minimum prescrit est de 2 mm (ce type de pose permet une plus grande prise du jointoyant sur les bords des carreaux, une plus grande absorption des éventuels mouvements de la sous-couche et une compensation des carreaux). Pour les carreaux non rectifiés, il faut réaliser un joint d'au moins 5 mm. Ceramiche Keope n'accepte pas les contestations relatives à la pose de matériau rectifié avec des joints inférieurs à 2 mm. Les produits en grès cérame Ceramiche Keope, bien qu'étant des matériaux très résistants, peuvent être façonnés (pour la conception de plans et d'escaliers) et perforés pour la mise en place d'installations technico-sanitaires en utilisant des disques diamantés spécifiques et des équipements adaptés.

AVERTISSEMENT :

- Ceramiche Keope, concernant le matériau déjà posé,*
- n'accepte pas les contestations dues à des vices apparents, définis dans le tableau 2 du présent manuel.*
- n'est pas responsable de la qualité du carrelage réalisé, mais uniquement des caractéristiques du matériau fourni.*

Il est conseillé de conserver, au terme de la pose, plusieurs carreaux à mettre de côté en vue de réparations éventuelles ou afin de disposer aussi d'un échantillon représentatif du matériau en cas de contestation.

DE_

Es wird empfohlen, spezielle, leistungsstarke Klebstoffe aufzutragen. Denken Sie daran, dass der Untergrund zum Zeitpunkt der Verlegung stabil, trocken und ausgereift sein muss. In jedem Fall müssen die jeweiligen Anweisungen der Hersteller der jeweiligen Untergründe und spezifischen Klebstoffe befolgt werden. Verlegemörtel auf Zementbasis müssen bei Raumtemperatur und in der Regel zwischen +5° C und +30/35° C aufgetragen werden. Informationen über die am besten geeigneten Klebstoffe für die Verlegung von Fliesen und Platten der Marke Ceramiche Keope sind der derzeit gültigen europäischen Norm EN12004 zu entnehmen. Während der Verlegung darf das Material nicht auf der Oberseite mit Bleistiften (Graphit) oder Permanentmarkern gekennzeichnet werden, insbesondere gilt dies für polierte Fliesen und Platten. Obwohl ein Anfeuchten der Fliesen vor dem Verlegen nicht erforderlich ist, ist es ratsam, wenn die Rückseite der Fliesen sehr staubig ist, sie schnell in sauberem Wasser abzuwaschen. Während des Zeitraums zwischen Abschluss der Verlegung und der Übergabe an den Auftraggeber müssen die Keramikfliesen sauber und frei von Zement, Sand, Mörtel und jeglichem anderen Material, das Flecken und/oder mechanischen Oberflächenabrieb verursachen kann, gehalten werden.

Die verlegten Flächen müssen vor Beschädigungen oder Verunreinigungen geschützt werden, die möglicherweise durch eine vorhersehbare Anwesenheit anderer Handwerker wie Maler, Elektriker, Zimmerleute usw. verursacht werden. Für die Verbandverlegung empfiehlt es sich, die Fliesen maximal um 20 cm zu versetzen. Für geschliffene Fliesen und Platten wird eine Fugenbreite von mindestens 2 mm vorgeschrieben (diese Art der Verlegung ermöglicht eine bessere Haftung des Fugenmörtels an den Seiten der Platten, eine bessere Aufnahme von Bewegungen des Untergrundes und eine Kompensation der Platten). Für nicht geschliffene Fliesen und Platten wird eine Fugenbreite von mindestens 5 mm vorgeschrieben. Ceramiche Keope akzeptiert keine Reklamationen, wenn geschliffene Fliesen und Platten mit einer Fugenbreite von weniger als 2 mm verlegt werden. Fliesen und Platten aus Feinsteinzeug von Ceramiche Keope können, obwohl es sich um sehr belastbare Ware handelt, auch zugeschnitten (für Arbeitsplatten, Treppen...) und für die Installation von technischen und sanitären Anlagen mit Bohrungen versehen werden, dazu müssen spezielle Diamantscheiben und geeignete Geräte verwendet werden.

HINWEIS:

Ceramiche Keope auf schon verlegten fliesen und platten:

- Ceramiche Keope akzeptiert keine beanstandungen aufgrund offensichtlicher mängel, wie in tabelle 2 dieses handbuchs definiert.*
- Ceramiche Keope ist nicht für die qualität der fliesenarbeiten verantwortlich, sondern nur für die eigenschaften des gelieferten materials.*

Es ist ratsam, einige ersatzfliesen am ende der installation für eventuelle reparaturen aufzubewahren oder im falle einer reklamation auf diese weise ein repräsentatives muster des materials zur hand zu haben.

It is advisable to keep some spare tiles at the end of the installation for possible future repairs or to have a sample of the material in the event of complaints.

Es ist ratsam, einige ersatzfliesen am ende der installation für eventuelle reparaturen aufzubewahren oder im falle einer reklamation auf diese weise ein repräsentatives muster des materials zur hand zu haben.

It is advisable to keep some spare tiles at the end of the installation for possible future repairs or to have a sample of the material in the event of complaints.

ES_

Se recomienda colocar la cerámica utilizando adhesivos específicos de altas prestaciones. Se recuerda que en el momento de la colocación, la subcapa debe ser estable, estar seca y curada. De todas maneras, siga las instrucciones de los fabricantes de los materiales para subcapas y adhesivos específicos utilizados. Los adhesivos cementosos se deben aplicar a temperatura ambiente, por lo general, entre +5 °C y +30/35 °C. Los adhesivos más adecuados para la colocación de los materiales marca Ceramiche Keope se pueden identificar sobre la base de la Normativa Europea EN 12004 vigente actualmente. Durante la colocación, no marque el material sobre la superficie de uso con lápices (grafito) ni marcadores indelebles, principalmente las cerámicas pulidas. Aunque no sea necesario mojar la cerámica antes de colocarla, si el reverso de la baldosa estuviera muy polvoriento, se recomienda lavarla rápidamente con agua limpia. Durante el período comprendido entre la conclusión de la colocación y la entrega al cliente final, el revestimiento cerámico deberá mantenerse limpio y libre de cemento, arena, mortero y de cualquier otro material que pueda causar manchas y/o fenómenos de abrasión mecánica superficial.

Es necesario proteger la colocación de daños o contaminaciones potencialmente causadas por el tráfico frecuente de otros operadores, tales como pintores, electricistas, carpinteros, etc. Para la colocación con junta corrida se recomienda desplazar las baldosas hasta un máximo de 20 cm. Para los materiales rectificadas, la junta mínima obligatoria es de 2 mm (este tipo de colocación permite un mayor agarre del producto de rejuntado a los bordes de las placas, una mayor absorción de los posibles movimientos de la subcapa y una compensación de las placas). Para las cerámicas no rectificadas, la junta debe ser de al menos 5 mm. Ceramiche Keope no acepta reclamaciones para colocación de material rectificado con juntas inferiores a 2 mm. Los productos de gres porcelánico, aunque sean materiales muy resistentes, pueden ser conformados (para la realización de encimeras, escaleras, etc.), perforados para la instalación de sistemas técnicos y sanitarios, utilizando discos diamantados especiales y herramientas adecuadas.

ADVERTENCIA:

Ceramiche Keope con el material ya colocado:

- no acepta reclamaciones debidas a vicios evidentes, así como definidos en la tabla 2 de e ste manual.*
- no responde sobre la calidad de la obra sino que responde únicamente de las características del material suministrado.*

Se recomienda conservar después de la colocación algunas cerámicas de repuesto para posibles reparaciones o incluso para tener una muestra representativa del material en caso de reclamación.

IT_

GIUNTI E STUCCATURE

Negli ambienti di grande dimensione è assolutamente necessario posizionare dei giunti di dilatazione con regolarità; mentre, per i piccoli ambienti è sufficiente lasciare un leggero stacco fra piastrellato e muri perimetrali, che verrà coperto dal battiscopa. In ogni caso è necessaria la supervisione del progettista o del direttore di cantiere che verifichi che l’installazione rispetti le normative vigenti nei singoli paesi. Per l'utilizzo di stucchi epossidici o con aggiunte di resine o similari, si consiglia di seguire con attenzione le indicazioni dei produttori perché il loro rapido indurimento richiede maggiori attenzioni. Riteniamo inoltre sia importante fare una prova preventiva di pulizia su una porzione di pavimento. In modo particolare per i prodotti lappati e levigati suggeriamo l'utilizzo di stucchi in cadenza di colore con la piastrella (es. evitare piastrella bianca con stucco nero). Dopo la stuccatura delle piastrelle è importante, a stucco ancora fresco, rimuovere immediatamente in modo accurato con spugna ed abbondante acqua lo stucco in eccesso. È comunque indispensabile alcuni giorni dopo la posa, a fughe asciutte, effettuare la pulizia di fondo mediante l'utilizzo di acidi tamponati (si veda il capitolo seguente: **Pulizia “dopo posa”**) al fine di rimuovere completamente tutti i residui di cantiere. Alcuni esempi di detergenti a base “acida” specifici per la pulizia dopo posa sono:

- DETERDEK FILA INDUSTRIA CHIMICA** *www.filachim.com*
- DELTA PLUS KERAKOLL** *www.kerakoll.com*
- KERANET MAPEI** *www.mapei.it*
- SERVICE ACIDO GEAL** *www.geal- chim.it*
- DISYCOTT FABER** *www.faberchimica.com*
- BONACLEAN BONASYSTEM** *www.bonasytemsitalia.it*

PULIZIA “DOPO POSA”

Gres porcellanato

La pulizia “dopo posa” è obbligatoria a fine cantiere. La rimozione inadeguata o tardiva dei residui della stuccatura utilizzata per le fughe può lasciare alonature difficili da rimuovere e creare sulla pavimentazione un film cementizio capace di assorbire ogni forma di sporco. È indispensabile sciogliere ed eliminare completamente questi residui con l'utilizzo di acidi tamponati diluiti in acqua (attenersi sempre alle istruzioni d’uso sulle confezioni dei prodotti utilizzati), che dovranno essere totalmente rimossi successivamente in breve tempo con abbondante risciacquo di tutto il pavimento. Si consiglia di ripetere l’operazione di lavaggio e risciacquo fino alla completa rimozione di ogni alone o residuo. Sugeriamo di eseguire un lavaggio preliminare su una superficie campione di alcuni metri quadrati; in caso di esito positivo, si estenderà la pulizia su tutta la superficie. Una volta effettuato il lavaggio sopracitato, è necessario eseguire un lavaggio basico o alcalino utilizzando detersivi sgrassanti. Questo perché il lavaggio acido può lasciare untuosità sul pavimento che potrebbe contribuire a trattenere lo sporco.

EN_

JOINTS AND GROUTING

In large, open spaces it is absolutely essential to position the expansion joints at regular intervals; in smaller rooms, on the other hand, it is sufficient to leave a slight space between the tiled surface and the walls around the room, which will be hidden by the skirting board. The tiles must be laid under the supervision of a planner or site manager, who must ensure that the work is carried out in accordance with the standards in force in the respective country. For the use of epoxy grouting or the addition of resins or similar substances, it is important to properly follow the manufacturer’s instructions as the fact such products harden more quickly requires greater attention. We also believe it is important to carry out a cleaning test on a part of the flooring. Especially for lapped and polished products, we suggest using grouts that match the colour of the tiles (e.g. avoid using black grout with white tiles).It is important to remove any excess grouting immediately and accurately after application while still fresh, using a sponge and plenty of water. A few days after laying, once the joints are completely dry, it is essential to thoroughly clean the tiled surface using buffered acids (see the following chapter: Cleaning “after laying”), in order to completely remove all residual substances. Some examples of “acid”-based detergents designed specifically for this purpose are:

- DETERDEK FILA INDUSTRIA CHIMICA** *www.filachim.com*
- DELTA PLUS KERAKOLL** *www.kerakoll.com*
- KERANET MAPEI** *www.mapei.it*
- SERVICE ACIDO GEAL** *www.geal- chim.it*
- DISYCOTT FABER** *www.faberchimica.com*
- BONACLEAN BONASYSTEM** *www.bonasytemsitalia.it*

CLEANING “AFTER LAYING”

Porcelain stoneware

Properly cleaning the tiles after they have been laid is crucial.If residues of the grouting used is removed inaccurately or too late, it may leave stains that are difficult to remove, and create a film of cement on the floor that can absorb any form of dirt. It is essential to loosen and eliminate these residues completely using buffered acids diluted in water (always follow the instructions provided on the box), which will then have to be removed quickly by rinsing the entire floor with plenty of clean water. We advise repeating this washing and rinsing operation several times until any stains or residues are completely removed. We suggest carrying out a preliminary test on a sample surface of several metres; if the results are good, you can then clean the entire surface.After this, the floor must then be cleaned thoroughly with a basic or alkaline detergent to degrease the surface. This is because acidic detergents may leave a film of grease on the floor that could trap dirt.

FR_

JOINTS ET JOINTOIEMENTS

Dans les espaces de grandes dimensions, il est absolument nécessaire de positionner des joints de dilatation avec régularité, tandis que pour les petits espaces, il est suffisant de laisser un léger espace entre le carrelage et les murs périphériques, qui sera ensuite recouvert par la plinthe. La supervision du concepteur ou du directeur de chantier est dans tous les cas nécessaire pour vérifier que l’installation respecte les normes en vigueur dans chaque pays. Pour l’utilisation de mastics époxys ou avec des adjonctions de résines ou similaires, il est conseillé de suivre avec attention les indications des fabricants car le durcissement rapide de ces derniers requiert des attentions supplémentaires. Il est également jugé important de faire, au préalable, un essai de nettoyage sur une portion du sol. Notamment, pour les produits lustrés et polis, il est suggéré d’utiliser des mastics dont la couleur est en harmonie avec celle du carreau (ex. Éviter un carreau blanc avec un mastic noir). Après le jointoiment des carreaux, il est important, lorsque le mastic est encore frais, d’enlever immédiatement avec soin le mastic en excès à l’aide d’une éponge et de beaucoup d’eau. Il est dans tous les cas indispensable, quelques jours après la pose, lorsque les joints sont secs, d’effectuer le nettoyage de fond en utilisant des acides tamponnés (voir le chapitre suivant intitulé : Nettoyage « après la pose ») afin d’enlever complètement tous les résidus des opérations de chantier. Voici quelques exemples de détergents à base « acide » spécifiques pour le nettoyage après la pose :

- DETERDEK FILA INDUSTRIA CHIMICA** *www.filachim.com*
- DELTA PLUS KERAKOLL** *www.kerakoll.com*
- KERANET MAPEI** *www.mapei.it*
- SERVICE ACIDO GEAL** *www.geal- chim.it*
- DISYCOTT FABER** *www.faberchimica.com*
- BONACLEAN BONASYSTEM** *www.bonasytemsitalia.it*

NETTOYAGE “APRÈS LA POSE”

Grès cérame

Le nettoyage « après la pose » est obligatoire à la fin des travaux. Le retrait inadapté ou tardif des résidus du jointoiment utilisé pour les joints peut laisser des auréoles difficiles à enlever et créer sur le sol un film cimentaire capable d’absorber les saletés en tout genre. Il est indispensable de détacher et d’éliminer complètement ces résidus à l’aide d’acides tamponnés dilués dans l’eau (toujours se conformer aux instructions d’utilisation sur les emballages des produits utilisés) qui devront ensuite être éliminés complètement et rapidement lors du rinçage abondant de l’ensemble du sol. Il est conseillé de répéter l’opération de lavage et de rinçage jusqu’à l’élimination complète de toutes les auréoles ou de tous les résidus. Il est suggéré d’effectuer un lavage préliminaire sur une surface échantillon de plusieurs mètres carrés. Dans le cas d’un résultat positif, le nettoyage pourra être étendu sur l’ensemble de la surface. Après avoir effectué le nettoyage susmentionné, il est nécessaire d’effectuer un lavage basique ou alcalin en utilisant des détersifs dégraissants. Cela car le lavage acide peut laisser une patine sur le sol qui pourrait contribuer à retenir la saleté.

DE_

FUGEN UND VERFUGUNG

Bei großen Räumen ist es unbedingt notwendig, in regelmäßigen Abständen Dehnungsfugen vorzusehen, während es in kleinen Räumen ausreicht, einen kleinen Abstand zwischen dem verfliesen Bereich und den Außenwänden zu lassen, der von der Sockelleiste verborgen werden wird. In jedem Fall ist es notwendig, dass der Planer oder Bauleiter die Arbeiten beaufsichtigt und überprüft, ob die Verlegung den in den einzelnen Ländern geltenden Vorschriften entspricht. Bei der Verwendung von Epoxidharzmörteln oder -fugenmassen mit Zusatz von Harzen oder ähnlichen Materialien ist es ratsam, die Anweisungen des Herstellers sorgfältig zu befolgen, da deren schnelle Aushärtung mehr Aufmerksamkeit erfordert. Wir halten es auch für wichtig, das Reinigungsmittel vor der Anwendung auf dem gesamten Boden zunächst auf einem Teil des Bodenbelags zu testen. Speziell für geläppte und polierte Produkte empfehlen wir die Verwendung von Fugenmörtel in einer zur Fliese passenden Farbe (z.B. weiße Fliesen mit schwarzer Fugenmasse vermeiden). Nach dem Verfugen der Feinsteinzeugfliesen ist es wichtig, solange die Fugenmasse noch feucht ist, sofort sorgfältig mit einem Schwamm die überschüssige Fugenmasse zu entfernen. Es ist jedoch unerlässlich, den Untergrund einige Tage nach der Verlegung, wenn die Fugen getrocknet sind, einer Grundreinigung mit gepufferten Säuren zu unterziehen (siehe folgendes Kapitel: Reinigung „nach der Verlegung“), um alle Baustellenreste vollständig zu entfernen. Beispiele für spezifische „saure“ Reinigungsmittel (Reinigungsmittel auf Säurebasis) für die Grundreinigung nach der Verlegung sind:

- DETERDEK FILA INDUSTRIA CHIMICA** *www.filachim.com*
- DELTA PLUS KERAKOLL** *www.kerakoll.com*
- KERANET MAPEI** *www.mapei.it*
- SERVICE ACIDO GEAL** *www.geal- chim.it*
- DISYCOTT FABER** *www.faberchimica.com*
- BONACLEAN BONASYSTEM** *www.bonasytemsitalia.it*

NETTOYAGE “APRÈS LA POSE”

Grès cérame

Le nettoyage « après la pose » est obligatoire à la fin des travaux. Le retrait inadapté ou tardif des résidus du jointoiment utilisé pour les joints peut laisser des auréoles difficiles à enlever et créer sur le sol un film cimentaire capable d’absorber les saletés en tout genre. Il est indispensable de détacher et d’éliminer complètement ces résidus à l’aide d’acides tamponnés dilués dans l’eau (toujours se conformer aux instructions d’utilisation sur les emballages des produits utilisés) qui devront ensuite être éliminés complètement et rapidement lors du rinçage abondant de l’ensemble du sol. Il est conseillé de répéter l’opération de lavage et de rinçage jusqu’à l’élimination complète de toutes les auréoles ou de tous les résidus. Il est suggéré d’effectuer un lavage préliminaire sur une surface échantillon de plusieurs mètres carrés. Dans le cas d’un résultat positif, le nettoyage pourra être étendu sur l’ensemble de la surface. Après avoir effectué le nettoyage susmentionné, il est nécessaire d’effectuer un lavage basique ou alcalin en utilisant des détersifs dégraissants. Cela car le lavage acide peut laisser une patine sur le sol qui pourrait contribuer à retenir la saleté.

DE_

FUGEN UND VERFUGUNG

Bei großen Räumen ist es unbedingt notwendig, in regelmäßigen Abständen Dehnungsfugen vorzusehen, während es in kleinen Räumen ausreicht, einen kleinen Abstand zwischen dem verfliesen Bereich und den Außenwänden zu lassen, der von der Sockelleiste verborgen werden wird. In jedem Fall ist es notwendig, dass der Planer oder Bauleiter die Arbeiten beaufsichtigt und überprüft, ob die Verlegung den in den einzelnen Ländern geltenden Vorschriften entspricht. Bei der Verwendung von Epoxidharzmörteln oder -fugenmassen mit Zusatz von Harzen oder ähnlichen Materialien ist es ratsam, die Anweisungen des Herstellers sorgfältig zu befolgen, da deren schnelle Aushärtung mehr Aufmerksamkeit erfordert. Wir halten es auch für wichtig, das Reinigungsmittel vor der Anwendung auf dem gesamten Boden zunächst auf einem Teil des Bodenbelags zu testen. Speziell für geläppte und polierte Produkte empfehlen wir die Verwendung von Fugenmörtel in einer zur Fliese passenden Farbe (z.B. weiße Fliesen mit schwarzer Fugenmasse vermeiden). Nach dem Verfugen der Feinsteinzeugfliesen ist es wichtig, solange die Fugenmasse noch feucht ist, sofort sorgfältig mit einem Schwamm die überschüssige Fugenmasse zu entfernen. Es ist jedoch unerlässlich, den Untergrund einige Tage nach der Verlegung, wenn die Fugen getrocknet sind, einer Grundreinigung mit gepufferten Säuren zu unterziehen (siehe folgendes Kapitel: Reinigung „nach der Verlegung“), um alle Baustellenreste vollständig zu entfernen. Beispiele für spezifische „saure“ Reinigungsmittel (Reinigungsmittel auf Säurebasis) für die Grundreinigung nach der Verlegung sind:

- DETERDEK FILA INDUSTRIA CHIMICA** *www.filachim.com*
- DELTA PLUS KERAKOLL** *www.kerakoll.com*
- KERANET MAPEI** *www.mapei.it*
- SERVICE ACIDO GEAL** *www.geal- chim.it*
- DISYCOTT FABER** *www.faberchimica.com*
- BONACLEAN BONASYSTEM** *www.bonasytemsitalia.it*

GRUNDREINIGUNG „NACH DER VERLEGUNG“

Feinsteinzeug

Die Grundreinigung „nach der Verlegung“ ist nach Abschluss der Arbeiten zwingend erforderlich. Die unsachgemäße oder verspätete Entfernung der zum Verfugen verwendeten Fugenmasse kann zu Schmutzrändern führen, die später schwierig zu entfernen sind und auf dem Bodenbelag einen Zementschleier hinterlassen, der alle Arten von Schmutz hartnäckig festhalten kann. Es ist unerlässlich, diese Rückstände mit Hilfe von wasserverdünnten, gepufferten Säuren aufzulösen und vollständig zu beseitigen (beachten Sie die Hinweise auf der Verpackung der verwendeten Produkte, die Rückstände müssen innerhalb kurzer Zeit sorgfältig durch das Nachspülen mit reichlich Wasser vom gesamten Bodenbelag vollständig entfernt werden). Das Waschen und Nachspülen sollte solange wiederholt werden, bis alle Schmutzränder oder Rückstände vollständig entfernt wurden. Wir empfehlen eine vorherige Testreinigung an einer kleinen Fläche von nur wenigen Quadratmetern durchzuführen. Im Falle eines positiven Ergebnisses kann dann die Reinigung der Gesamtfläche erfolgen. Sobald die Reinigung wie oben beschrieben erfolgt ist, muss eine Reinigung mit alkalischen Reinigungsmitteln erfolgen, dabei sind fettlösende Mittel zu verwenden. Dies ist notwendig, da säurehaltige Reiniger fettige Schlieren auf dem Boden zurücklassen könnten, die dazu beitragen könnten, Schmutz festzuhalten.

ES_

JUNTAS Y REJUNTADO

En los espacios de grandes dimensiones es absolutamente necesario colocar regularmente juntas de dilatación; mientras que, para las habitaciones pequeñas, es suficiente dejar un pequeño espacio entre el suelo de cerámica y las paredes perimetrales que será cubierto por el rodapié. De todas maneras, es necesaria la supervisión del diseñador o del director de obra que verifique que la instalación cumpla con las normas vigentes de cada país. Para el uso de productos epoxi de rejuntado o con resinas o similares, se recomienda seguir cuidadosamente las indicaciones de los fabricantes ya que su endurecimiento rápido requiere mayor atención. También consideramos que sea importante hacer una prueba previa de limpieza en una porción de suelo. Especialmente para los productos lapeados y pulidos sugerimos el uso de productos de rejuntado dentro de los matices de la cerámica (por ej., evitar las baldosas blancas con juntas negras). Después del rejuntado de las placas, cuando el producto todavía está fresco, es importante eliminar inmediatamente el exceso de producto de rejuntado con una esponja y abundante agua. De todas maneras, algunos días después de la colocación es indispensable limpiar la cerámica en profundidad utilizando ácidos tamponados (véase el siguiente capítulo: Limpieza “después de la colocación”) para eliminar por completo todos los residuos de obra. Algunos ejemplos de limpiadores a base de “ácido” específicos para la limpieza después de la colocación son:

- DETERDEK FILA INDUSTRIA CHIMICA** *www.filachim.com*
- DELTA PLUS KERAKOLL** *www.kerakoll.com*
- KERANET MAPEI** *www.mapei.it*
- SERVICE ACIDO GEAL** *www.geal- chim.it*
- DISYCOTT FABER** *www.faberchimica.com*
- BONACLEAN BONASYSTEM** *www.bonasytemsitalia.it*

LIMPIEZA “DESPUÉS DE LA COLOCACIÓN”

Gres porcelánico

La limpieza “después de la colocación” es obligatoria al final de las obras. La eliminación inadecuada o tardía de los residuos de rejuntado puede dejar manchas difíciles de eliminar y crear una película cementosa en el suelo capaz de absorber todo tipo de suciedad. Es esencial disolver y eliminar completamente estos residuos con ácidos tamponados diluidos en agua (siempre siga las instrucciones de uso de los envases de los productos utilizados), que posteriormente deberán ser eliminados por completo en poco tiempo enjuagando a fondo todo el pavimento. Se recomienda repetir la operación de lavado y enjuague hasta que las marcas o residuos desaparezcan por completo. Sugerimos realizar un lavado preliminar en una superficie de muestra de algunos metros cuadrados; en caso de resultado positivo, limpie toda la superficie.Tras haber realizado el lavado antes mencionado, es necesario realizar un lavado básico o alcalino con limpiadores desengrasantes. Esto se debe a que el lavado con ácido puede dejar el suelo grasoso, lo que podría ayudar a retener la suciedad.

IT_

Rivestimento pasta bianca

Il lavaggio dopo la posa è una fase di fondamentale importanza per tutti gli interventi successivi di manutenzione: con tale intervento si eliminano i residui di posa ed il normale sporco di cantiere come malta, colla, pittura etc. Una volta trascorsi i tempi di stagionatura dello stucco, procedere ad una pulizia con un detergente neutro attenendosi scrupolosamente alle istruzioni d'uso indicate sulla confezione dal produttore.

Decor *ed inserti speciali con applicazioni materiche e/o metalli preziosi (oro - argento)*
Bisogna prestare molta attenzione nella fase della pulizia così come nella fase di posa; evitare assolutamente l'uso di prodotti abrasivi che potrebbero graffiare e danneggiare la superficie. Per la pulizia Ceramiche Keope consiglia di utilizzare unicamente panni morbidi con acqua calda e alcool.

PULIZIA QUOTIDIANA
Dopo avere effettuato la pulizia “dopo posa” (capitolo precedente), per la pulizia quotidiana si consiglia l'utilizzo di un detergente neutro. Sono da evitare i detersivi in commercio contenenti cere e additivi lucidanti che possono depositare sul pavimento patine indesiderate. È sconsigliato vivamente l'impiego di cere, saponi oleosi, impregnanti e trattamenti vari (idro-oleo repellenti) sul prodotto Ceramiche Keope, la cui applicazione non è necessaria. In presenza di suddetti trattamenti occorre innanzitutto asportarli dal pavimento utilizzando i prodotti specifici, seguendo le istruzioni riportate dal produttore. In caso di patine create da sapone, calcare, sporco, occorre invece utilizzare un detergente acido, opportunamente diluito in acqua (attenersi alle istruzioni sull'etichetta del prodotto). È opportuno segnalare che l'acido fluoridrico (HF) e derivati possono danneggiare irrimediabilmente le piastrelle. Per la pulizia ordinaria Ceramiche Keope consiglia l'utilizzo di varechina o ammoniaca, opportunamente diluite in acqua. Tutte le superfici lappate o levigate necessitano di un utilizzo di attrezzature non abrasive durante la fase di pulizia per prevenire opacizzazioni e graffiature. Si consiglia inoltre l'asciugatura del pavimento onde evitare la formazione di aloni.

EN_

White body wall coverings

It is essential to clean the tiles after laying for the purpose of all subsequent maintenance operations: in this way, any residues of grouting as well as the normal dirt created during building works are eliminated, such as mortar, adhesive, paint etc. Once the grouting has properly dried, clean the surface with a neutral detergent, complying strictly with the instructions for use on the box or package.

Decorative trims and special inserts with relief patterns and/or precious metals (gold – silver)
Great attention must be paid during both the cleaning phase and the laying phase; it is vital to avoid the use of abrasive products that might scratch or damage the surface. For the cleaning of surfaces in Ceramiche Keope, we recommend using exclusively a soft cloth with warm water and alcohol.

EVERYDAY CLEANING
Once the surface has been cleaned “after laying” (see previous chapter), for everyday cleaning we recommend the use of a neutral detergent. Avoid using widely available detergents containing waxes and polishing additives that can deposit an undesired coating on the flooring. We strictly advise against the use of waxes greasy soaps, fillers and various treatments (water and oil repellent) on the Ceramiche Keope product, as they are not necessary. If the above treatments have been applied they will firstly need to be removed from the flooring using specific products following the manufacturer’s instructions. In the case of coatings created by soap, lime scale or dirt, you will need an acidic detergent, diluted in water as appropriate (always follow the instructions on the label). It should be noted that is hydrofluoric acid (HF) and its derivatives may damage the tiles permanently. For routine cleaning operations we recommend the use of bleach or ammonia, appropriately diluted in water. For all lapped or polished surfaces, the use of non-abrasive cleaning equipment is necessary to prevent the surface from losing its shine or becoming scratched. We also recommend leaving the floor to dry properly to prevent stains from forming.

FR_

Revêtement en pâte blanche

Le lavage après la pose est une phase d’une importance fondamentale pour toutes les interventions successives d’entretien: il permet d’éliminer les résidus de pose et la saleté qui viennent inévitablement des travaux comme le mortier, la colle, la peinture, etc. Une fois que les délais de séchage du mastic sont écoulés, il faut procéder à un nettoyage à l’aide d’un détergent neutre en respectant scrupuleusement les instructions d’utilisation indiquées par le fabricant sur l’emballage.

Décorations et insertions spéciales avec applications de matières et/ou de métaux précieux (or – argent)
Great attention must be paid during both the cleaning phase and the laying phase; it is vital to avoid the use of abrasive products that might scratch or damage the surface. For the cleaning of surfaces in Ceramiche Keope, we recommend using exclusively a soft cloth with warm water and alcohol.

NETTOYAGE QUOTIDIEN
Après avoir effectué le nettoyage « après la pose » (chapitre précédent), l'utilisation d'un détergent neutre est conseillée pour le nettoyage quotidien. Les détergents vendus dans le commerce, contenant des cires et des additifs brillants qui peuvent déposer sur le sol des patines indésirables, doivent être évités. Il est vivement déconseillé d'utiliser des cires, des savons oléagineux, des imprégnants et des traitements variés (hydrofuges et oléofuges) sur le produit Ceramiche Keope, dont l'application n'est pas nécessaire. En présence desdits traitements, il faut tout d'abord les faire disparaître du sol en utilisant des produits spécifiques, en suivant les instructions reportées par le fabricant. En cas de patines créées par du savon, du calcaire ou de la saleté, il faut au contraire utiliser un détergent acide, dilué de manière adaptée dans de l'eau (respecter les instructions indiquées sur l'étiquette du produit). Il convient de signaler que l'acide fluorhydrique (HF) et ses dérivés peuvent endommager irrémédiablement les carreaux. Pour le nettoyage ordinaire, Ceramiche Keope conseille l'utilisation d'eau de Javelou d'ammoniaque, diluées de manière adaptée dans de l'eau. Toutes les surfaces lustrées ou polies ont besoin d'être nettoyées avec des outils non abrasifs afin d'éviter les opacifications et les rayures. En outre, le séchage du sol est conseillé afin d'éviter la formation d'auréoles.

DE_

Weißscherbige Wandfliesen

Die Reinigung nach der Verlegung ist von grundlegender Bedeutung für alle nachfolgenden Reinigungs- und Pflegearbeiten: Durch diesen Eingriff werden Verlegerückstände und normaler Baustellenschmutz wie Mörtel, Klebstoffe, Farbe usw. beseitigt. Sobald die Fugenmasse getrocknet ist, muss eine Grundreinigung mit einem neutralen Reinigungsmittel erfolgen, dabei sind die Anweisungen des Herstellers sorgfältig zu befolgen.

Dekore und spezielle Einsätze mit Materialapplikationen und/oder Edelmetallen (Gold - Silber)
Sowohl bei der Reinigung als auch bei der Verlegung ist Vorsicht geboten. Vermeiden Sie unbedingt die Verwendung von scheuernden Reinigungsmitteln oder Werkzeugen, die Kratzer und Beschädigungen der Oberfläche verursachen können. Zur Reinigung empfiehlt Ceramiche Keope, nur weiche Tücher mit heißem Wasser und Alkohol zu verwenden.

ES_

Revestimiento de pasta blanca

El lavado después de la colocación es una etapa fundamental para todas las operaciones de mantenimiento posteriores: con dicha operación se eliminan los residuos de colocación y la suciedad normal de la obra, como morteros, adhesivos, pinturas, etc. Una vez transcurrido el tiempo de curado del producto de rejuntado, limpie con un limpiador neutro, siguiendo escrupulosamente las instrucciones de uso del envase del producto.

Decoraciones e insertos especiales con aplicaciones matéricas y/o metales preciosos (oro – plata)
Hay que tener mucho cuidado durante la etapa de limpieza así como durante la etapa de colocación; no utilice por ningún motivo productos abrasivos que podrían rayar y dañar la superficie. Para la limpieza, Ceramiche Keope recomienda utilizar únicamente paños suaves con agua caliente y alcohol.

TÄGLICHE REINIGUNG UND PFLEGE
Nach der Reinigung „nach der Verlegung“ (voriges Kapitel) wird für die tägliche Reinigung die Verwendung eines neutralen Reinigungsmittels empfohlen. Gewerbliche Reinigungsmittel mit Wachsen und Polierzusätzen, die unerwünschte Beschichtungen auf dem Boden hinterlassen können, sollten vermieden werden. Wir raten von der Verwendung von Wachsen, öligen Seifen, Imprägniermitteln und sonstigen Behandlungen (zur Erzielung von wasser- und ölabweisenden Eigenschaften) auf dem Ceramiche Keope-Produkt ab, eine solche Behandlung ist nicht erforderlich. Sollten solche Behandlungen bereits erfolgt sein, müssen diese mit speziellen Produkten und unter Beachtung der Anweisungen des Herstellers vom Boden entfernt werden. Hat sich eine Patina aus Seife, Kalkstein und Schmutz gebildet, muss stattdessen ein saures, in Wasser verdünntes Reinigungsmittel verwendet werden (Hinweise auf dem Produktetikett beachten). Es ist zu beachten, dass Flusssäure (Fluorwasserstoffsäure) (HF) und Derivate die Fliesen irreparabel beschädigen können. Für die normale Reinigung empfiehlt Ceramiche Keope die Verwendung von Chlorbleiche oder Ammoniak, das mit Wasser verdünnt wird. Alle geläppten oder polierten Oberflächen erfordern den Einsatz von nicht abrasiven Werkzeugen während der Reinigung, um den Verlust des Glanzes und Kratzer zu vermeiden. Der Boden sollte nach der Reinigung getrocknet werden, um die Bildung von Schlieren zu vermeiden.

ES_

Revestimiento de pasta blanca

El lavado después de la colocación es una etapa fundamental para todas las operaciones de mantenimiento posteriores: con dicha operación se eliminan los residuos de colocación y la suciedad normal de la obra, como morteros, adhesivos, pinturas, etc. Una vez transcurrido el tiempo de curado del producto de rejuntado, limpie con un limpiador neutro, siguiendo escrupulosamente las instrucciones de uso del envase del producto.

Decoraciones e insertos especiales con aplicaciones matéricas y/o metales preciosos (oro – plata)
Hay que tener mucho cuidado durante la etapa de limpieza así como durante la etapa de colocación; no utilice por ningún motivo productos abrasivos que podrían rayar y dañar la superficie. Para la limpieza, Ceramiche Keope recomienda utilizar únicamente paños suaves con agua caliente y alcohol.

LIMPIEZA DIARIA
Tras haber realizado la limpieza “después de la colocación” (capítulo anterior), para la limpieza diaria se recomienda utilizar un limpiador suave. Deben evitarse los limpiadores que contienen ceras y abrillantadores porque pueden depositar una película no deseada en el suelo. Se desaconseja usar ceras, jabones aceitosos, agentes de impregnación y tratamientos varios (hidro-óleo repelentes) en el producto Ceramiche Keope porque su aplicación no es necesaria. Ante la presencia de dichos tratamientos, en primer lugar es necesario eliminarlos del suelo utilizando los productos específicos, siguiendo las instrucciones dadas por el fabricante. En caso de películas creadas por jabón, cal y suciedad, es necesario utilizar un limpiador ácido, diluido adecuadamente en agua (siga las instrucciones de la etiqueta del producto). Cabe señalar que el ácido fluorhídrico (HF) y sus derivados pueden dañar irreparablemente las cerámicas. Para la limpieza ordinaria, Ceramiche Keope recomienda el uso de lejía o amoniaco diluidos adecuadamente en agua. Todas las superficies lapeadas o pulidas requieren el uso de equipos no abrasivos durante la etapa de limpieza para prevenir opacificaciones y rayados. También se recomienda secar el suelo para evitar que se formen marcas.

IT_

PULIZIA STRAORDINARIA

In caso di macchie particolari e/o particolarmente tenaci, è consigliabile l'uso di detergenti specifici, come indicato nella “Tabella 1 - prodotti per la pulizia”. Non va inoltre dimenticato che la rimozione di qualsiasi tipo di macchia è più agevole quando questa è ancora fresca. È importante fare sempre un test preventivo prima dell'uso dei prodotti detergenti, in particolare su gres porcellanato lappato o levigato.

EN_

EXTRAORDINARY CLEANING

In the case of particular and/or particularly stubborn stains, we recommend using specific detergents as those indicated in "Table 1 - cleaning products". It should furthermore not be forgotten that the removal of any type of stain is easier when the stain is still fresh. It is always important to test the detergents on a small area before applying to the entire surface, particularly in the case of porcelain stoneware with a lapped or polished finish.

FR_

NETTOYAGE SUPPLÉMENTAIRE

Dans le cas de taches particulières et/ou particulièrement tenaces, il est conseillé d'utiliser des détergents spécifiques, comme indiqué dans le “Tableau 1 - produits pour le nettoyage”. En outre, il ne faut pas oublier que l'élimination de toute tache est plus simple lorsque celle-ci est encore fraîche. Il est important de toujours faire un test préalable avant l'utilisation des produits détergents, notamment sur grès cérame lustré ou poli.

DE_

BESONDERE REINIGUNG

Bei besonderen oder besonders hartnäckigen Verschmutzungen sollten spezielle Reinigungsmittel verwendet werden, wie in der „Tabelle 1 - Reinigungsprodukte“ angegeben. Außerdem darf nicht vergessen werden, dass sich Flecken einfacher entfernen lassen, wenn sie noch frisch sind. Vor der Verwendung von Reinigungsmitteln, insbesondere bei geläpptem oder poliertem Feinsteinzeug, muss immer vorher ein Test durchgeführt werden.

ES_

LIMPIEZAS EXTRAORDINARIAS

En caso de manchas particulares y/o muy tenaces, se recomienda utilizar limpiadores específicos, como indicado en la “Tabla 1 - productos de limpieza”. Tampoco hay que olvidarse de que la eliminación de cualquier tipo de mancha es más fácil cuando todavía está fresca. Es importante realizar siempre una prueba antes de usar los productos de limpieza, especialmente con el gres porcelánico lapeado o pulido.

PRODOTTI PER LA PULIZIA / CLEANING PRODUCTS / PRODUITS POUR LE NETTOYAGE / REINIGUNGSPRODUKTE / PRODUCTOS DE LIMPIEZA

Tipo di sporco / <i>Type of dirt</i> <i>Type de salete</i> / <i>Verschmutzung</i> / <i>Tipo de suciedad</i>	Soluzione / <i>Solution</i> <i>Solution</i> / <i>Lösung</i> / <i>Solución</i>	Detergenti - Produttore / <i>Detergents-Manufacturer</i> <i>Detergents-Fabricants</i> / <i>Reinigungsmittel- Hersteller</i> / <i>Detergentes-Fabricante</i>
<p>Calcare / <i>Limescale</i> / <i>Calcaire</i> / <i>Kalkausblühungen</i> / <i>Cal</i></p> <p>Carbone / <i>Carbon</i> / <i>Charbon</i> / <i>Kohle</i> / <i>Carbón</i></p> <p>Cemento / <i>Cement</i> / <i>Ciment</i> / <i>Zement</i> / <i>Cemento</i></p> <p>Gesso / <i>Chalk</i> / <i>Plâtre</i> / <i>Gips</i> / <i>Yeso</i></p> <p>Malta / <i>Mortar</i> / <i>Mortier</i> / <i>Mörtel</i> / <i>Argamasa</i></p> <p>Matita / <i>Pencil</i> / <i>Crayon</i> / <i>Bleistift</i> / <i>Lápiz</i></p> <p>Residui metallici / <i>Metal residue</i> / <i>Résidu métallique</i> / <i>Metallreste</i> / <i>Residuo metal</i></p> <p>Ruggine / <i>Rust</i> / <i>Rouille</i> / <i>Rost</i> / <i>Óxido</i></p> <p>Stucco cementizio / <i>Cement grout</i> / <i>Ciment-joint</i> / <i>Zementmörtel</i> / <i>Estuco de cemento</i></p> <p>Stucco colorato / <i>Coloured grout</i> / <i>Mortier coloré</i> / <i>Farbiger fugenmasse</i> / <i>Estuco colorado</i></p> <p>Tempera murale / <i>Wall tempera</i> / <i>Détempres murales</i> / <i>Wandfarbe</i> / <i>Tempera mural</i></p>	<p>Soluzione acida / <i>Acid solution</i> / <i>Solution acide</i> / <i>Saurehaltig</i> / <i>Solucion ácida</i></p>	<p>DETERDEK / FILA SERVICE SOLVACID / GEAL CEMENT REMOVER / FABER KERANET / MAPEI DELTA PLUS / KERAKOLL BONACLEAN / BONASYSTEM</p>
<p>Birra / <i>Beer</i> / <i>Bière</i> / <i>Bier</i> / <i>Cerveza</i></p> <p>Caffè / <i>Coffee</i> / <i>Café</i> / <i>Kaffee</i> / <i>Café</i></p> <p>Coca cola / <i>Coke</i> / <i>Coca cola</i> / <i>Coca cola</i> / <i>Coca cola</i></p> <p>Vino / <i>Wine</i> / <i>Vin</i> / <i>Wein</i> / <i>Vino</i></p> <p>Gelato / <i>Ice cream</i> / <i>Glace</i> / <i>Eiscreme</i> / <i>Helado</i></p> <p>Pneumatico / <i>Tire marks</i> / <i>Pneu</i> / <i>Gummi</i> / <i>Neumático</i></p> <p>Grasso / <i>Fat</i> / <i>Grasses</i> / <i>Tierische fette</i> / <i>Grasa</i></p> <p>Ketchup / <i>Ketchup</i> / <i>Ketchup</i> / <i>Ketchup</i> / <i>Ketchup</i></p> <p>Maionese / <i>Mayonnaise</i> / <i>Mayonnaise</i> / <i>Mayonnaise</i> / <i>Mayonesa</i></p> <p>Marmellata / <i>Jam</i> / <i>Confiture</i> / <i>Stau</i> / <i>Mermelada</i></p> <p>Mostarda / <i>Mustard</i> / <i>Moutarde</i> / <i>Senf</i> / <i>Mostaza</i></p> <p>Rossetto / <i>Lipstick</i> / <i>Rouge à lèvres</i> / <i>Lippenstift</i> / <i>Pintalabios</i></p> <p>Suole di gomma / <i>Rubber soles</i> / <i>Huile de lin</i> / <i>Leinol</i> / <i>Suelas de goma</i></p> <p>Tinture per capelli / <i>Hair dye</i> / <i>Teinture pour cheveux</i> / <i>Haarfärbemittel</i> / <i>Tintura para cabello</i></p> <p>Urina / <i>Urine</i> / <i>Urine</i> / <i>Urin</i> / <i>Orina</i></p> <p>Vomito / <i>Vomit</i> / <i>Vomi</i> / <i>Erbrochenes</i> / <i>Vómito</i></p>	<p>Soluzione alcalina / <i>Alkaline solution</i> / <i>Solution alcaline</i> / <i>Alkalische lösung</i> / <i>Solucion alcalina</i></p>	<p>PS87 / FILA DETERFLASH / GEAL ALKALIN CLEANER / FABER AMMONIACA / UNIVERSALE</p>
<p>Alonatura ventose / <i>Stains from suction cups</i> / <i>Auréole de ventouses</i> / <i>Ränder von saugnapfen</i> / <i>Halos ventosas</i></p> <p>Catrame / <i>Tar</i> / <i>Goudron</i> / <i>Teer</i> / <i>Alquitrán</i></p> <p>Cera di candela / <i>Candle wax</i> / <i>Cire de bougie</i> / <i>Kerzenwachs</i> / <i>Cera de vela</i></p> <p>Cera protettiva / <i>Protective wax</i> / <i>Cire protectrice</i> / <i>Schutzwachs</i> / <i>Cera protectiva</i></p> <p>Colla / <i>Glue</i> / <i>Colle</i> / <i>Kleber</i> / <i>Pegamento</i></p> <p>Gomma da masticare / <i>Chewing gum</i> / <i>Chewing-gum</i> / <i>Kaugummi</i> / <i>Goma de mascar</i></p> <p>Inchiostro / <i>Ink</i> / <i>Encre</i> / <i>Tinte</i> / <i>Tinta</i></p> <p>Nastro adesivo / <i>Adhesive tape residue</i> / <i>Ruban adhésif</i> / <i>Klebeband</i> / <i>Cinta adhesiva</i></p> <p>Oli / <i>Oils</i> / <i>Huiles</i> / <i>Öl</i> / <i>Aceites</i></p> <p>Pennarello / <i>Marker pen</i> / <i>Feutre</i> / <i>Stifte</i> / <i>Rotulador</i></p> <p>Resine / <i>Resins</i> / <i>Résines</i> / <i>Harz</i> / <i>Resinas</i></p> <p>Smalto per unghie / <i>Nail polish</i> / <i>Vernis à ongles</i> / <i>Nagellack</i> / <i>Esmalte de uñas</i></p> <p>Sigarette / <i>Cigarette</i> / <i>Cigarette</i> / <i>Zigaretten</i> / <i>Cigarrillo</i></p>	<p>Solvente / <i>Solvent</i> / <i>Lösungsmittel</i> / <i>Lösungsmittel</i> / <i>Disolvente</i></p>	<p>FILA SOLV / FILA SOLVENT STRIPPER / FABER ACETONE / UNIVERSALE TRIELINA / UNIVERSALE</p>

Per eventuali richieste specifiche contattare / For any specific requests contact / Pour toute question spécifique, contactez / Für spezifische Anfragen kontaktieren Sie / Para eventuales solicitudes específicas, contactar:

- FILA**
www.filasolutions.com
- KERAKOLL**
www.kerakoll.com
- MAPEI**
www.mapei.it

- GEAL**
www.geal-chim.it
- FABER**
www.faberchimica.com
- BONASYSTEMS**
www.bonasysemtaliaa.it

IT_

POSA A SECCO PIASTRELLE K2 - 20MM

• Le pavimentazioni da esterno posate a secco in quota sono soggette all'azione del vento, con il rischio di sollevamento delle lastre. Il produttore raccomanda di far verificare l'idoneità del sistema di posa in quota da un tecnico abilitato in base alla normativa locale vigente ed alle condizioni d'uso, al fine di evitare il rischio di danni a persone e cose.

• Una lastra ceramica posata su un sistema sopraelevato può rompersi per impatto qualora un oggetto pesante cada sulla stessa da una certa altezza, con il rischio di seri danni per chiunque possa sostare o transitare sulla piastrella stessa. Il mancato rispetto delle istruzioni fornite dal produttore relative alla posa su sistemi sopraelevati può provocare seri danni alla persone.

ISTRUZIONI PER COMMITTENTI E PROGETTISTI

Quando l'applicazione delle lastre in 20mm prevede l'utilizzo del prodotto ceramico in termini strutturali, si raccomanda al progettista e/o committente un'attenta valutazione dei requisiti del progetto in relazione alle caratteristiche tecniche delle lastre. In particolare, al fine di evitare il rischio di danni a persone o cose il produttore raccomanda:

• Se l'applicazione prevede la posa sopraelevata, tenendo conto che una piastrella potrebbe rompersi in seguito alla caduta su di essa di un corpo pesante, verificare anticipatamente la destinazione d'uso specifica e attenersi alla tabella istruzioni di posa sopraelevata di seguito riportata ove, in determinate condizioni, è prevista l'applicazione di un rinforzo sul retro della piastrella (rete plus o acciaio zincato) fornito dal produttore.

• Con riferimento alla pavimentazione posata in quota, con qualunque sistema di posa a secco, rispettare le specifiche normative e condizioni d'uso locali riguardanti, tra l'altro, a titolo esemplificativo, l'azione del vento, il carico strutturale, le azioni sismiche, ecc.

• Il mancato rispetto delle raccomandazioni soprariportate possono portare ad un utilizzo improprio del prodotto e causare eventualmente gravi danni a persone o cose.

AVVERTENZA:

È bene prevedere le opportune pendenze trasversali e longitudinali da realizzare durante il livellamento o la compattazione per ottenere un drenaggio ottimale del piano di calpestio. Si raccomanda di prevedere un substrato realizzato con materiali drenanti per facilitare il deflusso dell'acqua ed evitarne il ristagno. Inoltre si consiglia una posa con fuga minima di 3 mm.

Vista la caratteristica di ingelività del gres porcellanato, la serie K2 ha il valore relativo all'assorbimento d'acqua praticamente nullo. Tale proprietà potrebbe comportare ristagni di acqua localizzati sulla pavimentazione, indipendentemente dalla realizzazione di una posa a regola d'arte del materiale.

EN_

DRY LAYING K2 – 20MM

• *Outdoor pavings installed unglued above the ground level are subject to the action of the wind, with the risk, in some cases, of becoming airborne. The manufacturer recommends to require the assistance of a qualified professional in order to check the suitability of the installation system above the ground adopted, in accordance with the local laws and regulations and the conditions of use. Failure to do so could result in serious injury or property damage.*

• *A ceramic slab installed on a raised pedestal system may fracture on impact if a heavy object is dropped onto it from a height, with a risk of injury to anyone standing or walking on such slab. Failure to adhere to the manufacturer's instructions for installation of slabs on raised pedestal systems may result in serious injury.*

INSTRUCTIONS FOR PROJECT ENGINEERS AND CUSTOMERS

If the application of the 20 mm slabs foresees the ceramic product used in structural installations, the project engineer and/or customer must carefully assess the project requirements with regard to the technical specifications of the slabs. To prevent the risk of damage or injury, the manufacturer recommends:

• *With regard to a raised floor installation a ceramic slab may fracture on impact if a heavy object falls on it from any significant height. Therefore, the manufacturer recommends to check the specific intended use before starting the installation and to follow table for raised installation provided below (page 364). In certain conditions, reinforcing must be applied on the back of the slabs (double fiberglass mesh or galvanized steel sheet) supplied and applied by the manufacturer.*

• *With reference to any dry installation system of flooring above the ground level, the manufacturer recommends to comply with local regulations and conditions of use with regard to wind-load, loadbearing, seismic events, etc.*

• *Failure to comply with these recommendations may lead to improper use of the product and could cause serious damage or injury.*

WARNING:

It is advisable to create the appropriate transverse and longitudinal gradients during levelling or compacting, in order to ensure optimal drainage of the floor.

We recommend the incorporation of a drainage substrate in order to facilitate runoff and prevent water pooling. It is also advisable to lay the tiles with a minimum joint of 3 mm.

Given the frost resistance of porcelain stoneware, the K2 series offers a water absorption value of practically zero. This property could lead to localised pooling of water on the floor, even if the tiles are laid properly.

FR_

POSE À SEC DES DALLES K2 - 20MM

• *Les dallages extérieurs posés sans collage sont soumis à l'action du vent, avec le risque de soulèvement des plaques, notamment ceux posés aux étages d'un bâtiment. Le fabricant recommande de faire vérifier par un technicien qualifié la bonne adaptation du système de pose en étages avec la réglementation en vigueur et les conditions d'utilisation locales, afin d'éviter le risque de dommages aux personnes et aux biens.*

• *Une dalle céramique posée sur un système surélevé peut se casser à la suite d'un impact d'un objet lourd qui y chuterait d'une certaine hauteur, avec le risque de sérieux dommages pour quiconque stationnerait ou transiterait sur ce carreau. Le non respect des instructions fournies par le fabricant relatives à la pose sur des systèmes surélevés peut provoquer de sérieux dommages aux personnes.*

INDICATIONS ET AVERTISSEMENTS POUR CONCEPTEURS ET MAITRES D'OEUVRE

Lorsque la mise en œuvre de dalles de 20 mm prévoit l'utilisation du produit céramique en termes structurels, il est recommandé aux concepteurs, maîtres d'œuvre et/ou aux maîtres d'ouvrage de faire une évaluation scrupuleuse du cahier des charges du projet eu égard aux caractéristiques techniques des dalles. En particulier, afin d'éviter le risque de dommages aux personnes ou aux biens, le fabricant recommande:

• *Si la mise en œuvre prévoit une pose surélevée, en tenant compte qu'un carreau pourrait se casser suite à la chute d'un corps lourd, de vérifier en avance la destination d'usage spécifique et de se conformer au tableau d'instructions de pose surélevée reproduit à la page 364, où, dans des conditions déterminées, il est prévu de rajouter un renforcement sur le revers du carreau (un treillis double en fibre de verre ou une feuille d'acier galvanisé), fourni par le fabricant.*

• *Concernant le dallage posé en étages, quelque soit le système de pose sans collage utilisé, de respecter les spécifications des normes et les conditions locales d'emploi, entre autre, à titre d'exemple, l'action du vent, le chargement structurel, les actions sismiques, etc.*

• *Le non respect des recommandations reproduites ci-dessus peut conduire à un usage impropre du produit et éventuellement causer de graves dommages aux personnes ou aux biens.*

AVERTISSEMENT:

On conseille de prévoir des inclinaisons transversales et longitudinales opportunes à réaliser au cours du nivellement et du compactage pour obtenir un drainage optimal du plan de piétinement. On recommande de prévoir un substrat réalisé avec des matériaux drainants pour favoriser l'écoulement de l'eau et en éviter la stagnation. On conseille également une pose avec un joint minimal de 3 mm.

Vu le caractère ingélif du grès cérame, la valeur d'absorption de l'eau de la série K2 est pratiquement nulle. Cette propriété pourrait provoquer des stagnations d'eau localisées sur le carrelage, indépendamment de la réalisation d'une pose du matériel dans les règles de l'art.

DE_

TROCKENE VERLEGUNG K2 - 20MM

• *Bodenbeläge die trocken im Außenbereich in der Höhe verlegt werden, unterliegen der Wirkung des Windes, wodurch die Gefahr besteht, dass die Platten aufgeworfen werden. Der Hersteller erteilt daher die Empfehlung, dass die Eignung des Systems für eine Verlegung in der Höhe durch einen zugelassenen Sachverständigen überprüft wird, wobei die lokal gültigen Vorschriften und Nutzungsbedingungen zu beachten sind, um die Gefahr von Personen- und Sachschäden zu vermeiden.*

• *Eine Keramikplatte die auf einem Doppelbodensystem verlegt ist, kann durch den Aufprall eines aus einer bestimmten Höhe herabfallenden Gegenstandes zerbrechen. Hier besteht das Risiko schwerer Verletzungen für all jene die auf der Fliese gehen, oder stehen. Bei Nichtberücksichtigung der vom Hersteller vorgegebenen Verlegevorschriften für Doppelbodensysteme, kann es zu schwerwiegenden Verletzungen der Personen kommen.*

HINWEISE FÜR PLANER UND AUFTRAGGEBER

Falls der Einsatz der 20 mm Platten eine Verwendung des keramischen Produkts als Bestandteil der Gebäudestruktur vorsieht, ist der Planer und/oder der Auftraggeber angehalten, eine sorgfältige Prüfung der Voraussetzungen des Projekts in Bezug auf die technischen Eigenschaften der Platten vorzunehmen. Insbesondere zur Vermeidung der Gefahr von Personen- und Sachschäden, erteilt der Hersteller folgenden Hinweis:

• *Unter Berücksichtigung des Umstandes, dass die Fliese infolge eines schweren herabfallenden Gegenstandes zerbrechen könnte, muss im Falle einer Anwendung als Doppelboden im voraus eine Prüfung des spezifischen Einsatzbereiches erfolgen. Außerdem ist die nachfolgende Tabelle mit Verlegeanweisungen zu berücksichtigen (Seite 364), die unter bestimmten Bedingungen die Aufbringung einer Verstärkung auf der Rückseite der Fliese vorsieht (Doppelglasfasernetz oder einen verzinkten Stahlblech) welche vom Produzenten geliefert wird.*

• *Mit Bezug auf Bodenbeläge die trocken im Außenbereich in der Höhe verlegt werden, sind die spezifischen lokalen Vorschriften und Nutzungsbedingungen zu berücksichtigen, die unter anderem, wie zum Beispiel für die Wirkung des Windes, der strukturellen Belastung, der Wirkung von Erdbeben, etc., vorgesehen sind: Die Nichtberücksichtigung der oben genannten Anweisungen kann zu einer unsachgemäßen Verwendung des Produkts führen und eventuell schwerwiegende Personen- und Sachschäden verursachen.*

• *Die Nichtberücksichtigung der oben genannten Anweisungen kann zu einer unsachgemäßen Verwendung des Produkts führen und eventuell schwerwiegende Personen- und Sachschäden verursachen.*

HINWEIS:

Bei der Nivellierung und Kompaktierung müssen die notwendigen Quer- und Längsneigungen geschaffen werden, damit die ordnungsgemäße Drainage der Lauffläche möglich ist. Es wird empfohlen einen aus drainierendem Material bestehenden Unterboden vorzusehen, um das Abfließen des Wassers zu erleichtern und ein Anstauen zu vermeiden. Außerdem wird die Verlegung mit einer Mindestfuge von 3 mm empfohlen.

Aufgrund der Frostbeständigkeit des Feinsteinzeugs hat die Serie K2 einen Wasseraufnahmewert von praktisch Null. Diese Eigenschaft könnte, selbst bei fachgerechter Verlegung des Materials, zum Anstauen des Wassers auf dem Boden führen.

ES_

COLOCACIÓN EN SECO K2 - 20MM

• Los pavimentos de exteriores colocados en seco en altura están sometidos a la acción del viento, con el riesgo del levantamiento de las losas. El fabricante recomienda verificar la idoneidad del sistema de colocación en altura por un técnico autorizado en base a la normativa vigente localmente y a las condiciones de uso, a fin de evitar el riesgo de daños a personas y cosas.

• *Una losa cerámica colocada sobre un sistema sobreelevado puede romperse por impacto en caso de que un objeto pesado la golpee cayendo de una cierta altura, con el riesgo de serios daños para cualquiera que pueda encontrarse en la zona afectada. El no respeto de las instrucciones entregadas por el fabricante respecto a la colocación en sistemas sobreelevados puede provocar serios daños a las personas.*

INSTRUCCIONES PARA CLIENTES Y PROYECTISTAS

Cuando la aplicación de las losas de 20 mm contempla el empleo del producto cerámico en términos estructurales, se recomienda al proyectista y/o cliente una cuidadosa evaluación de los requisitos del proyecto en función de las características técnicas de las losas. En especial, a fin de evitar el riesgo de daños a personas o cosas el fabricante recomienda:

• *Si la aplicación contempla la colocación sobreelevada, teniendo en cuenta que una baldosa podría romperse como consecuencia de la caída de un cuerpo contundente, verificar anticipadamente el destino de uso específico y seguir la tabla de instrucciones de la colocación sobreelevada presentada a continuación (p.364) en los casos en que, en determinadas condiciones, es prevista la aplicación de un refuerzo por el revés de la baldosa (doble red de fibra de vidrio o con una lámina de acero cincado) abastecida por el fabricante.*

• *Con referencia a la pavimentación colocada en altura, con cualquier sistema de colocación en seco, respetar las particulares normativas y condiciones de uso concernientes, entre otras cosas y en forma de ejemplo, la acción del viento, la carga estructural, las acciones sísmicas, etc.*





• *Si no se respetan las recomendaciones antedichas puede verificarse un uso impropio del producto que puede causar graves daños a personas o cosas.*

ADVERTENCIA:

Es conveniente prever las adecuadas inclinaciones transversales y longitudinales a realizar durante la nivelación o la compactación a fin de obtener un drenaje optimizado del plano de tránsito. Se recomienda instalar una subcapa realizada con materiales drenantes para facilitar la evacuación del agua y evitar estancamientos. Además se aconseja efectuar la colocación con fuga mínima de 3 mm.

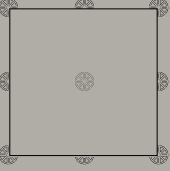
Vista la característica de resistencia al hielo del gres porcelánico, la serie K2 tiene valor relativo a la absorción de agua prácticamente nulo. Esta propiedad podría determinar estancamientos de agua localizados sobre el pavimento, independientemente de la efectiva correcta colocación del material.

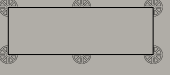
POSA A SECCO DI PIASTRELLE K2-20MM / DRY LAYING K2 – 20MM / POSE À SEC DES DALLES K2-20MM / TROCKENE VERLEGUNG K2-20MM / COLOCACIÓN EN SECO K2-20MM

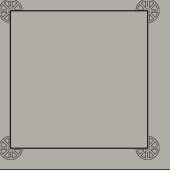
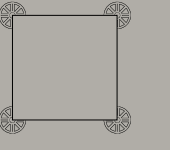
Formato K2 - 20 MM / Size K2 - 20mm Format K2 - 20 MM / Formaten K2 - 20 mm / Formatos K2 - 20 MM	Altezza fino a 2 cm / Up to 2 cm / Jusqu'à 2 cm / Höhe bis 2 cm / Altura hasta 2 cm	Altezza da 2 a 10 cm* / From 2 to 10 cm* De 2 à 10 cm* / Höhe von 2 bis 10 cm* / Altura de 2 a 10 cm*	Altezza da 10 a 30 cm* / From 10 to 30 cm* De 10 à 30 cm* / Höhe von 10 bis 30 cm* / Altura de 10 a 30 cm*
120x120 (48"x48") 	9 piedi / 9 supports / 9 supports / 9 stelzlager / 9 soportes 6,25 pc/m²	9 piedi / 9 supports / 9 supports / 9 stelzlager / 9 soportes 6,25 pc/m² + doppia rete di fibra di vetro plus o lamina di acciaio zincato. / + double fiberglass mesh or galvanized steel sheet. / + double filet en fibre de verre plus ou plaque en acier zingué. / + Doppelten glasfaser plus oder verzinkten stahlblech. / + Doble fibra de vidrio plus o lámina de acero cincado	9 piedi / 9 supports / 9 supports / 9 stelzlager / 9 soportes 6,25 pc/m² + doppia rete di fibra di vetro plus o lamina di acciaio zincato. / + double fiberglass mesh or galvanized steel sheet. / + double filet en fibre de verre plus ou plaque en acier zingué. / + Doppelten glasfaser plus oder verzinkten stahlblech. / + Doble fibra de vidrio plus o lámina de acero cincado
60x120 (24"x48") 45x90 (18"x36") 	6 piedi / 6 supports / 6 supports / 6 stelzlager / 6 soportes 3,4 pc/m² - 60x120 6,0 pc/m² - 45x90	6 piedi / 6 supports / 6 supports / 6 stelzlager / 6 soportes 3,4 pc/m² - 60x120 6,0 pc/m² - 45x90 + doppia rete di fibra di vetro plus o lamina di acciaio zincato. / + double fiberglass mesh or galvanized steel sheet. / + double filet en fibre de verre plus ou plaque en acier zingué. / + Doppelten glasfaser plus oder verzinkten stahlblech. / + Doble fibra de vidrio plus o lámina de acero cincado	6 piedi / 6 supports / 6 supports / 6 stelzlager / 6 soportes 3,4 pc/m² - 60x120 6,0 pc/m² - 45x90 + doppia rete di fibra di vetro plus o lamina di acciaio zincato. / + double fiberglass mesh or galvanized steel sheet. / + double filet en fibre de verre plus ou plaque en acier zingué. / + Doppelten glasfaser plus oder verzinkten stahlblech. / + Doble fibra de vidrio plus o lámina de acero cincado
40x120 (16"x48") 	6 piedi / 6 supports / 6 supports / 6 stelzlager / 6 soportes 5,5 pc/m²	6 piedi / 6 supports / 6 supports / 6 stelzlager / 6 soportes 5,5 pc/m² + doppia rete di fibra di vetro plus o lamina di acciaio zincato. / + double fiberglass mesh or galvanized steel sheet. / + double filet en fibre de verre plus ou plaque en acier zingué. / + Doppelten glasfaser plus oder verzinkten stahlblech. / + Doble fibra de vidrio plus o lámina de acero cincado	6 piedi / 6 supports / 6 supports / 6 stelzlager / 6 soportes 5,5 pc/m² + doppia rete di fibra di vetro plus o lamina di acciaio zincato. / + double fiberglass mesh or galvanized steel sheet. / + double filet en fibre de verre plus ou plaque en acier zingué. / + Doppelten glasfaser plus oder verzinkten stahlblech. / + Doble fibra de vidrio plus o lámina de acero cincado
30x120 (12"x48") 	6 piedi / 6 supports / 6 supports / 6 stelzlager / 6 soportes 7 pc/m²	6 piedi / 6 supports / 6 supports / 6 stelzlager / 6 soportes 7 pc/m² + doppia rete di fibra di vetro plus o lamina di acciaio zincato. / + double fiberglass mesh or galvanized steel sheet. / + double filet en fibre de verre plus ou plaque en acier zingué. / + Doppelten glasfaser plus oder verzinkten stahlblech. / + Doble fibra de vidrio plus o lámina de acero cincado	6 piedi / 6 supports / 6 supports / 6 stelzlager / 6 soportes 7 pc/m² + doppia rete di fibra di vetro plus o lamina di acciaio zincato. / + double fiberglass mesh or galvanized steel sheet. / + double filet en fibre de verre plus ou plaque en acier zingué. / + Doppelten glasfaser plus oder verzinkten stahlblech. / + Doble fibra de vidrio plus o lámina de acero cincado
90x90 (36"x36") 75x75 (30"x30") 	4 piedi / 4 supports / 4 supports / 4 stelzlager / 4 soportes 3 pc/m²	Non utilizzabile / Not applicable / Pas applicable / Nicht verwendet / 4 soportes No utilizable	Non utilizzabile / Not applicable / Pas applicable / Nicht verwendet / 4 soportes No utilizable
60x60 (24"x24") 	4 piedi / 4 supports / 4 supports / 4 stelzlager / 4 soportes 3,4 pc/m²	4 piedi / 4 supports / 4 supports 4 stelzlager / 4 soportes 3,4 pc/m²	4 piedi / 4 supports / 4 supports / 4 stelzlager / 4 soportes 3,4 pc/m² + doppia rete di fibra di vetro plus o lamina di acciaio zincato. / + double fiberglass mesh or galvanized steel sheet. / + double filet en fibre de verre plus ou plaque en acier zingué. / + Doppelten glasfaser plus oder verzinkten stahlblech. / + Doble fibra de vidrio plus o lámina de acero cincado

IT_

*** per USA, AUSTRALIA e CANADA: tutti i formati K2 - 20mm sono considerati adatti per la posa su supporti con altezza massima pari a 2 cm.**

FR_

** pour USA, AUSTRALIE et CANADA: toutes les formats K2 - 20mm sont considérées appropriées pour la pose sur des supports d'une hauteur maximale de 2 cm.*

EN_

** for USA, AUSTRALIA and CANADA: all sizes K2 - 20mm are considered suitable for laying on supports at a maximum height of 2 cm.*

DE_

** für USA, AUSTRALIEN und KANADA: alle Formaten K2 - 20 mm gelten als geeignet für die Verlegung auf Stützen mit einer maximalen Höhe von 2 cm.*

ES_

** para USA, AUSTRALIA y CANADÁ: todos los formatos K2 - 20 mm se consideran adecuados para colocar sobre soportes con una altura máxima de 2 cm.*

IT_

Per richieste particolari e per avere informazioni specifiche relative alla doppia fibra di vetro o alla lamina di acciaio zincato da incollare sul retro, contattare il reparto tecnico di Ceramiche Keope. Per dettagli sul prodotto in 20 mm di spessore e sui relativi sistemi di posa ed, in particolare, per le raccomandazioni, accorgimenti, limitazioni di utilizzo e precauzioni in fase di posa, si raccomanda di prendere visione del catalogo K2 di Ceramiche Keope e del sito **keope.com**

EN_

Nota: Ceramiche Keope è responsabile esclusivamente nel caso in cui fornisca l'intero sistema (piastrella + doppia rete di fibra di vetro plus o lamina di acciaio). Ceramiche Keope non può essere ritenuta responsabile per sistemi di rinforzo delle lastre che non ha fornito. In caso di rottura, la lastra deve essere sostituita immediatamente.

AVVERTENZA:

Ceramiche Keope a materiale già posato:

- non accetta contestazioni dovuti a vizi palesi, così come definiti nella tabella 2 del presente manuale.
- non risponde sulla qualità dell'opera piastrellata ma solamente sulle caratteristiche del materiale fornito.

È bene conservare al termine della posa, alcune piastrelle di scorta per eventuali riparazioni o anche per disporre di un campione rappresentativo del materiale in caso di contestazione.

FR_

*Pour de plus amples détails sur les spécificités techniques du treillis plus ou de la plaque en acier zingué, nous vous invitons à contacter le bureau commercial de Ceramiche Keope. Pour de plus amples détails sur les produits de 20 mm d'épaisseur et sur leurs systèmes de pose, et en particulier, pour les recommandations, mises à jour, limitations d'usage et précautions en phase de pose, veuillez prendre connaissance du catalogue K2 de Ceramiche Keope et du site **keope.com***

Note: Ceramiche Keope n'est tenue responsable que dans le cas où elle fournit le système complet (dalle + treillis plus ou plaque d'acier zingué). Ceramiche Keope décline toute responsabilité en cas de renforts de dalles non fournis par ses soins. En cas de casse, la dalle doit être remplacée immédiatement.

AVERTISSEMENT :

Ceramiche Keope, concernant le matériau déjà posé,

- n'accepte pas les contestations dues à des vices apparents, définis dans le tableau 2 du présent manuel.
- n'est pas responsable de la qualité du carrelage réalisé, mais uniquement des caractéristiques du matériau fourni.

Il est conseillé de conserver, au terme de la pose, plusieurs carreaux à mettre de côté en vue de réparations éventuelles ou afin de disposer aussi d'un échantillon représentatif du matériau en cas de contestation.

EN_

*For further information and for technical specifications about the double fiberglass mesh and/ or the galvanized steel sheet to be applied on the back of the tile, to contact the Technical Department of Ceramiche Keope. For further details on the 20 mm product and the installation systems, in particular for recommendations, restrictions of use, and precautions during installation, please refer to the K2 catalogue and to the website **keope.com***

Note: Ceramiche Keope is responsible only if it supplies the whole system (tile + fiber mesh plus or galvanized sheet). Ceramiche Keope cannot be held responsible for reinforcing systems that has not supplied. In case of breakage, tile must be replaced immediately.

WARNING:

for material that has already been laid, Ceramiche Keope:

- does not accept any complaints for visible defects, as defined in table 2 of this manual
- does not accept liability for the quality of the tiled surface but only for the characteristics of the material supplied.

Once the material has been laid, it is wise to keep aside a few tiles for possible future repairs or to have a sample of the material in the event of complaints.

DE_

*Für weitere Informationen und für spezielle Informationen zu der doppelten Glasfaser oder zu dem verzinkten Stahlblech, das an die fliese geklebt wird, kontaktieren Sie bitte das Unternehmen. Für Details zum Produkt mit 20 mm Stärke und entsprechende Verlegesysteme, insbesondere hinsichtlich Hinweise und Anmerkungen, Nutzungseinschränkungen und Vorsichtsmaßnahmen während der Verlegung, wird die Einsicht des Katalogs K2 von Ceramiche Keope und der Webseite **keope.com** empfohlen.*

Note: Ceramiche Keope kann nur haftbar gemacht werden, wenn das ganze System (Fliese + Verstärkung) komplett geliefert worden ist. Ceramiche Keope kann nicht für Platten Verstärkungssysteme verantwortlich gemacht werden, die nicht geliefert wurden. Bei Bruch die Platte bitte sofort austauschen.

HINWEIS:

Ceramiche Keope auf schon verlegten fliesen und platten:

- Ceramiche Keope akzeptiert keine beanstandungen aufgrund offensichtlicher mängel, wie in tabelle 2 dieses handbuchs definiert.
- Ceramiche Keope ist nicht für die qualität der fliesenarbeiten verantwortlich, sondern nur für die eigenschaften des gelieferten materials.

Es ist ratsam, einige ersatzfliesen am ende der installation für eventuelle reparaturen aufzubewahren oder im falle einer reklamation auf diese weise ein repräsentatives muster des materials zur hand zu haben.

ES_

*Para más detalles y para obtener informaciones específicas respecto de la doble fibra de vidrio plus o de la lámina de acero cincado a pegar en el revés de la baldosa, rogamos ponerse en contacto con el departamento técnico de Ceramiche Keope. Para mayores informaciones sobre el producto de 20 mm de espesor y sobre los relativos sistemas de colocación y, en especial, para las recomendaciones, precauciones y límites de empleo en fase de colocación, se recomienda consultar el catálogo K2 y el sitio **keope.com***

Nota: Ceramiche Keope es responsable solo si ha abastecido el sistema completo (baldosa + refuerzo). No puede ser considerada responsable por sistemas de refuerzo que no ha abastecido. En caso de ratura, la losa tiene que ser reemplazada inmediatamente.

ADVERTENCIA:

Ceramiche Keope, con el material ya colocado:

- no acepta reclamaciones debidas a vicios evidentes, así como definidos en la tabla 2 de este manual.
- no responde sobre la calidad de la obra sino que responde únicamente de las características del material suministrado.

Se recomienda conservar después de la colocación algunas cerámicas de repuesto para posibles reparaciones o incluso para tener una muestra representativa del material en caso de reclamación.

Causale / Type of defect Motif / Grund / Defecto	Descrizione / Description Description / Beschreibung / Descripción	Eccezioni / Exceptions Exceptions / Ausnahmen / Excepciones
Calibro / Caliber Calibre / Werkmaß / Calibre	Piastrelle di dimensioni (Larghezza/Lunghezza) differenti all'interno dello stesso lotto (Calibro/Caliber) con deviazioni superiori alle tolleranze rivendicate in scheda tecnica. / Tiles with different dimensions (Width/Length) in the same batch (Caliber), with deviations exceeding the tolerances claimed on the technical specification sheet. / Carreaux de dimensions différentes (Largeur/Longueur) à l'intérieur du même lot (Calibre) avec des déviations supérieures aux tolérances indiquées dans la fiche technique. / Fliesen verschiedener Abmessungen (Breite/Länge) innerhalb eines Loses (Werkmaß), wobei die Abweichungen die im technischen Datenblatt angegebenen Toleranzen überschreiten. / Cerámicas de diferentes medidas (Ancho/Largo) pertenecientes al mismo lote (Calibre) con diferencias superiores a las tolerancias indicadas en la ficha técnica.	-
Planarità / Planarity Planéité / Ebenheit / Planicidad	Piastrelle concave o convesse (curvatura dello spigolo), con angoli rialzati o abbassati (svergolamento) con deviazioni superiori rispetto alle tolleranze rivendicate in scheda tecnica. / Tiles that are concave or convex (curved at the edges), have raised or lowered corners (warpage) with deviations exceeding the tolerances claimed on the technical specification sheet. / Carreaux concaves ou convexes (courbure de l'arête), avec des angles rehaussés ou abaissés (gauchissement)avec des déviations supérieures aux tolérances indiquées dans la fiche technique. / Konkave oder konvexe Fliesen (Krümmung der Kante), mit erhöhten oder abgesenkten Winkeln (verzogene Fliesen), wobei die Abweichungen die im technischen Datenblatt angegebenen Toleranzen überschreiten. / Cerámicas cóncavas o convexas (curvatura del canto), con esquinas curvadas hacia arriba o hacia abajo (pandeo) con diferencias superiores a las tolerancias indicadas en la ficha técnica.	-
Ortogonalità - Rettilinearità / Orthogonality-Straightness / Orthogonalité-Rectitude / Rechtwinkligkeit-Geradlinigkeit / Ortogonalidad-Rectitud	Piastrelle con lati non rettilinei e non ortogonali ("effetto trapezio") con deviazioni superiori rispetto alle tolleranze rivendicate in scheda tecnica. / Tiles with edges that are not straight (and not orthogonal ("trapezoid effect")) with deviations exceeding the tolerances claimed in the technical specification sheets. / Carreaux avec des bords non rectilignes et non orthogonaux (« effet trapèze ») avec des déviations supérieures aux tolérances indiquées dans la fiche technique. / Fliesen mit nicht geraden und nicht rechtwinkligen Seiten („Trapezeffekt"), wobei die Abweichungen die im technischen Datenblatt angegebenen Toleranzen überschreiten. / Cerámicas con lados no rectos y no ortogonales ("efecto trapezio") con diferencias superiores a las tolerancias indicadas en la ficha técnica.	-
Spessore / Thickness Épaisseur / Stärke / Espesor	Piastrelle con spessore differente all'interno della stessa scatola con deviazioni superiori rispetto alle tolleranze rivendicate in scheda tecnica. / Tiles with differing thicknesses in the same box with deviations exceeding the tolerances claimed on the technical specification sheet. / Carreaux d'épaisseurs différentes à l'intérieur de la même boîte avec des déviations supérieures aux tolérances indiquées dans la fiche technique. / Fliesen mit unterschiedlicher Stärken innerhalb einer Kiste, wobei die Abweichungen die im technischen Datenblatt angegebenen Toleranzen überschreiten. / Cerámicas con diferentes espesores dentro de la misma caja con diferencias superiores a las tolerancias indicadas en la ficha técnica.	-
Crepe / Cracks Craquelures / Risse / Grietas	Piastrelle con crepe parallele o ortogonali al bordo oppure superficiali con immediato distacco di placche superficiali dopo battitura. / Tiles with cracks running parallel or orthogonally to the edge, or surface cracks leading to the immediate detachment of bits of the surface coating when the tiles are tapped to level the surface. / Carreaux avec des craquelures parallèles ou orthogonales sur leur bord ou leur surface avec un détachement immédiat de plaques superficielles après le battage. / Fliesen mit parallelen oder rechtwinkligen Rissen an den Kanten oder auf der Oberfläche mit sofortigem Abplatzen von oberflächlichen Stückchen beim Anklopfen. / Cerámicas con grietas paralelas o perpendiculares al canto o superficiales con desprendimiento inmediato de las placas superficiales después del golpeo.	-
Sbeccature / Chipping Fissures / Dellen, angeschlagene fliesen / Desconchados	Piastrelle con angoli e/o bordi rotti dentro alle scatole. / Tiles with broken corners and/or edges inside the box. / Carreaux avec des angles et/ou des bords cassés à l'intérieur des boîtes. / Fliesen mit angeschlagenen Ecken und/oder Kanten in den Kisten. / Cerámicas con esquinas rotas y/o cantos rotos dentro de las cajas.	-

Causale / Type of defect Motif / Grund / Defecto	Descrizione / Description Description / Beschreibung / Descripción	Eccezioni / Exceptions Exceptions / Ausnahmen / Excepciones
Difetti superficiali / Surface defects Défauts de surface / Oberflächliche Mängel / Defectos de superficie	Piastrella con buchi, spillature, crateri, vulcani, avvallamenti, inquinamento di impasto e presenza della marca (impressa dal retro del materiale ceramico) sulla superficie di esercizio / Tiles with (pin) holes, depressions, dimples, puckering, any contamination in the ceramic body; visible signs of brands/trademarks (left by the back of other ceramic tiles) on the surface. / Carreaux avec trous, coulées, creux, bosses, dépressions, contamination de la pâte et avec présence de la marque (imprimée par le dos du matériau céramique) sur la surface d'utilisation. / Fliese mit Löchern, kleinen nadelstichförmigen Vertiefungen, Kratern, Einsenkungen, verschmutzter Masse und Sichtbarkeit der Marke (durchgedrückt von der Rückseite des Keramikmaterials) auf der Oberfläche. / Cerámicas con agujeros, puntos, cráteres, volcanes, depresiones, contaminación de la masa y presencia de la marca (grabada en el reverso de la cerámica) en la superficie superior.	Il segno delle ventose visibile solo in condizioni di umidità per pochi secondi non viene considerato come difetto della piastrella in quanto nelle normali condizioni di esercizio non si percepisce. / If suction pads leave visible signs for a few seconds in humid conditions, this is not considered a defect of the tile, as such signs are not visible in normal conditions. / La marque des ventouses, visible uniquement dans des conditions d'humidité pendant quelques secondes, n'est pas considérée comme un défaut dans la mesure où celle-ci ne se voit pas dans des conditions normales d'utilisation. / Die nur bei Feuchtigkeit für einige Sekunden sichtbare Saugnapfmarkierung gilt nicht als Mangel der Fliese, da sie unter normalen Bedingungen nicht wahrgenommen wird. / La marca de las ventosas visible solo en condiciones de humedad durante unos segundos no se considera un defecto de la placa ya que en condiciones normales de servicio no se percibe.
Difetto di decorazione / Decorative defects Défaut de décoration / Dekorationsmängel / Defecto de decoración	Piastrelle con difetti di serigrafia, di smalto, gocce, righe della digitale / Tiles with defects in the silk-screen printing, glazing, droplets and lines created during digital printing. / Carreaux avec des défauts de sérigraphie, d'émail, de gouttes et de lignes de la machine numérique. / Fliesen mit Fehlern im Druck, der Glasur, Tropfen, Streifen bei Digitaldruck. / Cerámicas con defectos de serigrafía, esmalte, gotas, líneas de la decoración digital.	-
Fuori tono / Colour defects Hors ton / Farbtonfehler / Fuera de tono	Piastrelle con tono eccessivamente diverso dal riferimento e/o campione fornito al cliente. / Tiles with a tone of colour that differs excessively from the reference piece and/or sample provided to the customer. / Carreaux avec un ton excessivement différent de la référence et/ou de l'échantillon fourni au client. / Fliesen mit einem Ton, der sich zu sehr von der Referenz und/oder dem Muster unterscheidet, das dem Kunden geliefert wurde. / Cerámicas con un tono que es muy diferente al producto de referencia y/o a la muestra suministrada al cliente.	-
Toni mescolati / Mixed tones Tons / Mélangés / Vermischte farbtöne / Tonos mezclados	Piastrelle all'interno dello stesso lotto con un grado di stonalizzazione superiore al V-Shade riportato a catalogo. / Tiles in the same batch with a colour shading level above the V-Shade stated in the catalogue. / Carreaux à l'intérieur du même lot avec un degré de dénuançage supérieur au V-Shade mentionné dans le catalogue. / Fliesen innerhalb derselben Partie mit Farbabweichungen, die größer sind als der im Katalog angegebene V-Shade-Wert. / Cerámicas del mismo lote con un grado de destonalización superior al V-Shade indicado en el catálogo.	-
Difetto di lappatura-levigatura / Lapping-polishing defects / Défaut de lustrage-polissage / Lappungs-polierfehler / Defecto de lapeado-pulido	Piastrelle con "bucatura" eccessiva, "pelate" (affioramento del colore dell'impasto), bordi graffiati e/o opachi, graffi superficiali di forma semicircolare / Tiles on which the surface presents an excessive number of "pinholes" or appears to "peel" (the colour of the ceramic body resurfaces), that have scratched and/or opaque edges, surface scratches of a semicircular shape, ... / Carreaux avec une quantité excessive de trous, « pelades » (apparition de la couleur de la pâte), bords rayés et/ou opaques, rayures superficielles de forme semi circulaire, ... / Fliesen mit übermäßigen Einstichen abgeblätterte Fliesen (Farbe des Scherbens schlägt durch), verkratzte und/oder matte Kanten, halbrunde oberflächliche Kratzer usw. / Cerámicas con "orificios" excesivos, con afloramiento del color del cuerpo, cantos rayados y/o opacos, rayas en la superficie de forma semicircular, etc.	-
Problemi di taglio-scaglie / Cutting problem-flaking / Problèmes de coupe-écailles / Schnittprobleme-splitter / Problemas de corte-descascarillado	Piastrelle che si scheggiano, scagliano, rompono durante il taglio lineare e/o foratura quadrangolare e/o circolare. / Tiles that chip, flake or break when straight cuts or rectangular/round holes are made in the tile. / Carreaux qui s'ébrèchent, s'écaillent et se brisent durant la coupe linéaire et/ou la perforation quadrangulaire et/ou circulaire. / Fliesen, die beim geraden Zuschnitt und/oder dem Anbringen von quadratischen und/oder kreisförmigen Bohrungen brechen. / Cerámicas que se astillan, descascarillan, se rompen durante el corte lineal y/o durante la perforación cuadrangular o circular.	-

Causale / Type of defect Motif / Grund / Defecto	Descrizione / Description Description / Beschreibung / Descripción	Eccezioni / Exceptions Exceptions / Ausnahmen / Excepciones
Crepe-scatoloni-sfilato / <i>Cracks-blistering / Craquelures-décrochages superficiels / Risse-abblättern / Grietas-desventados</i>	Piastrelle che successivamente alla posa manifestano crepe parallele o ortogonali al bordo oppure superficiali ("scatolone"). / <i>Tiles which (after laying) present cracks that run parallel or orthogonally to the edge or surface cracks ("blistering")./ Carreaux qui, après la pose, manifestent des craquelures parallèles ou orthogonales sur leur bord ou leur surface (« décrochage superficiel »).</i> / <i>Fliesen, die nach der Verlegung Risse parallel oder orthogonal zur Kante oder oberflächliche Risse („abplatzende Hohlstellen“) aufweisen.</i> / <i>Cerámicas que después de la colocación presentan grietas paralelas o perpendiculares al canto o superficiales (“desventada“).</i>	Attenzione perché le rotture delle piastrelle tagliate per il perimetro della pavimentazione, il più delle volte, sono conseguenza di mancati accorgimenti nel taglio e/o nella della ceramica. / <i>Great care should be taken when cutting and laying ceramic tiles around edges and other objects, as breakages are often due to the failure to take appropriate precautions./ Attention car les ruptures des carreaux coupés pour le périmètre du sol, le plus souvent, sont la conséquence d'un manque de précautions au moment de la coupe et/ou la pose de la céramique.</i> / <i>Gehen Sie mit dem Material vorsichtig um, denn der Bruch der Fliesen, die für den Bodenbelag zugeschnitten wurden geht meistens auf mangelnde Aufmerksamkeit beim Schneiden und/oder Verlegen zurück.</i> / <i>La rotura de las baldosas cortadas para el perimetro del suelo, la mayoría de las veces, son el resultado de la falta de precauciones durante el corte y/o la colocación de la cerámica.</i>

Cavillo tardivo / <i>Subsequent crackling / Tressaillage à effet retardé / Spätere haarrisse / Cuarteo diferido</i>	Piastrelle smaltate da rivestimento che manifestano fenomeni di cavillo "tardivo" dopo alcuni mesi dalla posa in opera. / <i>Glazed wall tiles on which the phenomenon of crackling starts to appear "subsequently", even several months after laying.</i> / <i>Carreaux émaillés pour revêtement qui présentent des phénomènes de tressaillage « à effet retardé », quelques mois après la pose.</i> / <i>Emaillierte glasierte Wandfliesen, die wenige Monate nach der Verlegung Haarrisse zeigen.</i> / <i>Cerámicas esmaltadas de revestimiento que presentan fenómenos de cuarteo "diferido" después de unos meses de la colocación.</i>	Questo difetto può essere dovuto alla ceramica ma il più delle volte alla posa non eseguita "a regola d'arte". / <i>This defect may be due to the ceramic product, but is normally caused by improper laying of the tiles.</i> / <i>Ce défaut peut être dû à la céramique mais il est le plus souvent dû à la pose qui n'a pas été réalisée dans « les règles de l'art ».</i> / <i>In diesen Fällen kann die Keramik mangelhaft sein, aber meistens gehen diese Probleme auf die nicht „fachmännisch“ durchgeführte Verlegung zurück.</i> / <i>Este defecto puede deberse a la cerámica, pero la mayoría de las veces se debe a una colocación incorrecta.</i>

Danneggiamento da gelo / <i>Frost damage / Déterioration due au gel / Frostschäden / Daños por hielo</i>	Piastrelle che dopo alcuni mesi dalla posa in esterno mostrano la comparsa di fratture e scagliature abbastanza tipiche della ceramica, il più delle volte di tipo "concoide". / <i>Tiles laid outside that start to show fractures and flaking typical of ceramic tiles, often of the "conchoidal" type.</i> / <i>Carreaux qui, quelques mois après la pose en extérieur, montrent l'apparition de fractures et d'écaillassez typiques de la céramique, le plus souvent de type « conchoïde ».</i> / <i>Fliesen, bei denen einige Monate nach der Verlegung Brüche oder - meist muschelförmige - Absplütterungen auftreten, wie sie recht typisch für Keramik sind.</i> / <i>Cerámicas que después de algunos meses de la colocación en exteriores presentan fracturas y descascarillados bastante típicos de la cerámica, la mayoría de las veces tipo "concoidea".</i>	Il distacco e/o sollevamento di piastrelle posate in esterno come pure la rottura di piastrelle singole e/o adiacenti fra loro non è da imputare alla ceramica ma ad una errata installazione. / <i>If tiles laid outdoors become detached from the substrate or raised, or if individual and/or adjacently laid tiles break, this is not due to the ceramic product but to incorrect laying.</i> / <i>Le détachement et/ou soulèvement de carreaux posés à l'extérieur ainsi que la rupture de carreaux individuels et/ou placés les uns à côté des autres ne sont pas dus à la céramique mais à une installation incorrecte.</i> / <i>Das Ablösen und/oder Abheben von im Außenbereich verlegten Fliesen sowie der Bruch einzelner und/oder benachbarter Fliesen ist nicht auf die Keramik, sondern auf eine fehlerhafte Verlegung zurückzuführen.</i> / <i>El despegue y/o levantamiento de baldosas colocadas en exteriores, así como la rotura de baldosas individuales y/o adyacentes entre sí no se deben atribuir a la cerámica sino a una colocación incorrecta.</i>

Macchiabilità / <i>Inclination to stains / Salissure / Fleckenempfindlichkeit / Manchas</i>	Piastrelle che trattengono in modo anomalo lo sporco e risultano essere di difficile pulibilità. / <i>Tiles that trap dirt to an excessive extent and are difficult to clean.</i> / <i>Carreaux qui retiennent de manière anormale la saleté et s'avèrent être difficiles à nettoyer.</i> / <i>Fliesen, die Schmutz auf ungewöhnliche Weise zurückhalten und schwer zu reinigen sind.</i> / <i>Cerámicas que retienen la suciedad de forma anormal y son difíciles de limpiar.</i>	Verosimilmente si tratta di un difetto occulto ma c'è da verificare se è dovuto a prestazioni inadeguate del materiale ceramico installato e/o errata manutenzione del cliente finale. / <i>This is probably due to a hidden defect, but it is also necessary to check if this is due to insufficient characteristics of the tile used for the purpose, and/or incorrect maintenance on the part of the end customer.</i> / <i>Il s'agit vraisemblablement d'un vice caché mais il faut vérifier si celui-ci est dû à des prestations inadaptées du matériau céramique installé et/ou à un entretien incorrect effectué par le client final.</i> / <i>Es handelt sich wahrscheinlich um einen versteckten Mangel, aber es muss geprüft werden, ob er auf eine unzureichende Leistung des verlegten Materials und/oder eine fehlerhafte Pflege durch den Endkunden zurückzuführen ist.</i> / <i>Probablemente se trata de un defecto oculto, pero hay que comprobar si se debe a prestaciones inadecuadas del material cerámico instalado y/o a un mantenimiento incorrecto del cliente final.</i>

IT_ NORMATIVA UNI 11493-2013

Il presente manuale è stato redatto nel rispetto della norma nazionale UNI 11493 del 2013 che regola la posa delle piastrelle ceramiche a pavimento e a parete, per interni ed esterni, installate principalmente con adesivi, ma anche con malta cementizia o altri sistemi. Lo scopo della norma, che si pone comunque come un testo di riferimento per il settore, è quello di assicurare il raggiungimento di un alto livello qualitativo e il suo mantenimento nel tempo.

Questo manuale descrive situazioni puramente indicative e non intende sostituire in alcun modo né le normative in materia di igiene e sicurezza sul lavoro in vigore in ciascun Paese, né le prescrizioni, le avvertenze e le raccomandazioni contenute nelle schede e nei manuali di prodotti, utensili, macchinari e impianti utilizzati, alle quali è sempre necessario attenersi. La loro attenta lettura e comprensione da parte di personale tecnico qualificato, insieme all'utilizzo di dispositivi di protezione individuale, è fondamentale per uno svolgimento delle attività corretto e sicuro.

FR_ RÈGLEMENT UNI 11493-2013

Ce manuel a été rédigé conformément au règlement national UNI 11493 de 2013 concernant la pose de carreaux de céramique sur des sols ou des murs, pour l'intérieur ou l'extérieur, généralement à l'aide de mortier-colle, mais aussi de mortier de ciment ou d'autres produits. Le but de ce règlement, qui a pour vocation de servir de texte de référence pour notre secteur d'activité, est de garantir un haut niveau de qualité, durable à long terme.

Ce manuel rend compte de situations purement indicatives et ne vise aucunement à remplacer les règlements en vigueur dans chaque pays en matière d'hygiène et de sécurité sur le lieu de travail, ni les prescriptions, avertissements et conseils contenus dans les fiches et les manuels des produits, outils, machines et appareils utilisés, qui doivent toujours être consultés et respectés. Une lecture attentive de ces derniers et leur compréhension par le personnel technique qualifié, ainsi que l'utilisation d'équipements de protection individuelle sont essentielles pour la bonne exécution des travaux, en conditions de sécurité.

EN_ UNI 11493-2013

This manual has been written in conformity to Italian standard UNI 11493 of 2013 governing the installation of ceramic floor and walls tiles in indoor and outdoor applications, mainly with adhesive but also with cement-based mortar or other systems. The purpose of UNI 11493 standard is to serve as a reference for the ceramic tile sector and to ensure the respect and maintenance of the highest quality standards over time.

This manual describes purely indicative situations and is not intended to replace Italian standards governing hygiene and safety in the workplace or the instructions, precautions and recommendations provided in the data sheets and manuals of products, tools, machines and equipment, which must always be respected. The thorough application of such standards and instructions by qualified technical person and the use of suitable personal protective equipment is essential to the correct and safe completion of tile installation work.

DE_ NORM UNI 11493-2013

Die vorliegende Anleitung wurde in Anlehnung an die italienische Norm UNI 11493 aus dem Jahr 2013 verfasst, in der die Verlegung von Boden- und Wandkeramikfliesen für Innen- und Außenbereiche reglementiert ist; die Verlegung erfolgt hauptsächlich mit Klebern, kann aber auch mit Zementmörtel oder unter Anwendung anderer Systeme ausgeführt werden. Die Ziele der Norm, die auf jeden Fall als Bezugsdokument für den betreffenden Sektor gilt, sind die Sicherstellung eines hohen qualitativen Niveaus und die langfristige Einhaltung dieses Niveaus.

In dieser Anleitung sind Standardsituationen beschrieben; sie ist kein Ersatz für die einschlägigen und in den jeweiligen Ländern geltenden Normen hinsichtlich Hygiene und Sicherheit am Arbeitsplatz oder für Vorschriften, Warnungen und Empfehlungen, die in den Datenblättern und Anleitungen der verwendeten Produkte, Werkzeuge, Maschinen und Anlagen enthalten sind und auf jeden Fall immer beachtet werden müssen. Die sorgfältige Lektüre und das Verständnis des jeweiligen Inhalts vonseiten der qualifizierten Fachkräfte und die Verwendung angemessener persönlicher Schutzausrüstungen sind für eine korrekte und sichere Ausführung der Arbeiten unabdingbar.

ES_ NORMA UNI 11493-2013

Este manual ha sido elaborado en cumplimiento de la norma nacional UNI 11493 de 2013, que regula la colocación de lasas cerámicas en pisos y paredes, para interiores y exteriores, instaladas principalmente con adhesivos, pero también con mortero de cemento u otros sistemas. El objetivo del Reglamento, que en cualquier caso es un texto de referencia para el sector, es garantizar que se alcance y mantenga un alto nivel de calidad a lo largo del tiempo.

Este manual describe situaciones puramente indicativas y no pretende en modo alguno sustituir a la normativa de seguridad y salud laboral vigente en cada país, ni a los requisitos, las advertencias y las recomendaciones contenidos en las hojas de datos y los manuales de los productos, las herramientas, la maquinaria y los sistemas utilizados, que deben respetarse en todo momento. Su cuidadosa lectura y comprensión por parte de personal técnico cualificado, junto con el uso de equipos de protección personal, es esencial para llevar a cabo las actividades de forma correcta y segura.

CONDIZIONI GENERALI DI VENDITA / Rev.1a - 01 Gennaio 2018

A.- MODALITA' DI CONCLUSIONE DEL CONTRATTO

A.1.- Le presenti Condizioni Generali di Vendita disciplinano ogni contratto di Vendita tra il Venditore e l'Acquirente ed ogni loro modifica o deroga deve essere concordata per iscritto.

A.2.- Eventuali offerte, accrediti e/o abbuoni accordati da agenti o da altri intermediari, non sono ritenuti validi se non confermati per iscritto dal Venditore.

A.3.- L'Acquirente invia al Venditore, direttamente o per il tramite di agenti, Ordini scritti che devono contenere l'indicazione dei codici dei Prodotti richiesti, delle quantità, del loro prezzo e della destinazione. L'Ordine inviato dall'Acquirente è irrevocabile.

A.4.- La Vendita dovrà ritenersi conclusa nel momento in cui: (i) l'Acquirente riceva da parte del Venditore una Conferma scritta via e-mail, fax o altri mezzi telematici, conforme ai termini e alle condizioni dell'Ordine; o (ii) in caso di Conferma inviata dal Venditore contenente condizioni difformi dall'Ordine ricevuto dall'Acquirente quando questi l'accetti per iscritto o comunque non la contesti entro 7 (sette) giorni dalla ricezione; o (iii) in assenza di conferma scritta da parte del Venditore, nel momento in cui i Prodotti saranno consegnati e caricati dall'Acquirente.

B.- PREZZI

B.1.- Salvo diversa pattuizione scritta, i prezzi di vendita concordati di volta in volta si intendono al netto per contanti e per consegna franco stabilimento del Venditore indicato nella Conferma d’Ordine.

C.- CARATTERISTICHE DEI PRODOTTI

C.1.- L'Acquirente dichiara di aver preso visione ed attenersi al contenuto della seguente documentazione pubblicata nel sito internet aziendale: 1) Manuale di Posa, Uso, Pulizia e Manutenzione e 2) Schede tecniche.

C.2. Data la intrinseca variabilità del prodotto ceramico, le caratteristiche dei campioni e/o modelli inviati in precedenza dal Venditore all'Acquirente sono da considerarsi indicativi e non vincolanti.

C.3. Salvo specifiche richieste da concordare prima della Conferma d’Ordine, il Venditore non garantisce che l'ordine del singolo articolo venga evaso tutto con un medesimo lotto di produzione.

D.- TERMINI DI CONSEGNA

D.1.- I termini di consegna sono da intendersi indicativi e la proroga di essi non può far maturare all'Acquirente alcun diritto a richiedere indennizzi, ogni eccezione rimossa.

D.2.- Se, trascorsi 10 (dieci) giorni dalla data di avviso di merce pronta, l'Acquirente non ritira il materiale, il Venditore si riserva di stabilire discrezionalmente un nuovo termine di consegna.

E.- RESA E SPEDIZIONE

E.1.- L'eventuale variazione della destinazione dei Prodotti, diversa da quella concordata in Conferma d’Ordine, deve essere comunicata dall'Acquirente per iscritto entro e non oltre il secondo giorno antecedente a quello previsto per il ritiro presso la sede del Venditore. Il Venditore si riserva la facoltà di non accettare la variazione della destinazione dei Prodotti. Nel caso si verifichi che la destinazione effettiva del Prodotto sia stata diversa da quella dichiarata dall'Acquirente, il Venditore si riserva la facoltà di sospendere l'esecuzione delle forniture in corso e/o risolvere i contratti in corso senza che l'Acquirente possa rivendicare risarcimenti diretti e/o indiretti di alcun tipo.

E.2.- Salvo patto contrario, la fornitura della merce si intende Franco Fabbrica (EXW ai sensi degli Incoterms 2010) e ciò anche quando sia convenuto che la spedizione o parte di essa venga curata dal Venditore su mandato dell'Acquirente. In ogni caso i rischi passano all'Acquirente al più tardi con la consegna al primo trasportatore.

E.3.- Ferma restando l'estraneità del Venditore rispetto al contratto di trasporto, il Venditore non potrà essere indicato come “shipper” nella polizza di carico. La comunicazione del peso lordo del container allo spedizioniere, non costituisce alcuna assunzione di responsabilità da parte del Venditore ai fini della Convenzione SOLAS (Safety Of Life At Sea). In nessun caso tale comunicazione potrà essere intesa come VGM (Verified Gross Mass).

E.4.- L'Acquirente s’impegna affinché il mezzo inviato presso i magazzini del Venditore sia idoneo al carico in relazione alla natura dei Prodotti. Nel caso il mezzo che si presenta comporti significative difficoltà per le operazioni di carico, il Venditore si riserva di addebitare una penale pari al 4% del valore dei prodotti a copertura dei maggiori costi logistici. Se il mezzo convenuto non è assolutamente idoneo, il Venditore si riserva la facoltà di negare le operazioni di carico senza che nulla possa essere richiesto dall'Acquirente a titolo di risarcimento per ogni onere diretto e/o indiretto che ne possa derivarne.

E.5.- È compito dell'Acquirente incaricare il vettore di controllare i prodotti prima del carico; eventuali osservazioni in relazione all’integrità degli imballi e della rispondenza delle quantità caricate a quelle indicate sul documento di trasporto, devono essere sollevate dal vettore al momento del carico. Tali osservazioni devono essere riportate su tutte le copie dei documenti di trasporto, altrimenti i prodotti caricati s’intendono integri e completi. Ne deriva che il Venditore non si assume alcuna responsabilità in relazione a mancanze o danni dei prodotti non segnalati dal vettore.

E.6.- È altresì responsabilità dell'Acquirente incaricare il vettore di verificare le modalità e la stabilità del carico sul mezzo affinché durante il trasporto non si verifichino rotture e affinché siano rispettate tutte le disposizioni di sicurezza riguardanti la circolazione stradale.

F.- PAGAMENTI

F.1.- Qualsiasi obbligazione di pagamento deve essere adempiuta presso la sede legale del Venditore. Eventuali pagamenti ad agenti, rappresentanti o ausiliari di commercio non si intendono effettuati finché le relative somme non pervengono al Venditore.

F.2.- E' fatto divieto all'Acquirente di eseguire il proprio adempimento mediante pagamenti provenienti da paesi diversi dal proprio paese di residenza se trattasi di paesi che non garantiscono un adeguato scambio di informazioni con l'Italia. In caso di violazione di tale divieto, il Venditore ha facoltà di risolvere il contratto per giusta causa senza che l'Acquirente possa vantare il diritto di ottenere alcun risarcimento per l'eventuale danno subito.

F.3.- Eventuali spese di bollo ed incasso effetti e tratte sono a carico dell'Acquirente. In caso di inadempimento, anche solo parziale, dal giorno fissato per il pagamento decorreranno a favore del Venditore gli interessi moratori nella misura prevista dal d.lgs. 09/10/2002 n. 231.

F.4.- Salvo diversi accordi scritti, l'Acquirente si impegna a non compensare alcun credito, comunque insorto, nei confronti del Venditore.

G.- RECLAMI

G.1.- Al ricevimento dei Prodotti, l'Acquirente dovrà sottoporli ad accurato controllo attraverso un esame visivo effettuato conformemente alle indicazioni riportate al punto 7 delle norme UNI EN ISO 10545-2.

G.2.- L’installazione e la posa dei Prodotti deve essere effettuata attenendosi scrupolosamente alle raccomandazioni inerenti le attività da svolgere prima e durante la posa in opera indicate nel documento 1) Manuale di Posa, Uso, Pulizia e Manutenzione pubblicato nel sito internet del Venditore e sulla confezione del prodotto e/o all’interno della stessa. Non sono considerati vizi del Prodotto quelli generati da un'errata installazione e dalla mancata/errata manutenzione (difformi dalle indicazioni fornite nel 1) Manuale di Posa, Uso, Pulizia e Manutenzione), da una non idonea destinazione d’uso e/o dalla normale usura nel tempo.

G.3.- Fatti salvi i limiti di accettabilità previsti dalla norma internazionale EN 14411 (ISO 13006), le Parti riconoscono come Vizi Palesi i difetti dei Prodotti riscontrabili già al momento del loro ricevimento tali da rendere il materiale inidoneo all'uso o da diminuirne in modo apprezzabile il valore. Rientrano in tale categoria i difetti come definiti nel documento 1) Manuale di Posa, Uso, Pulizia e Manutenzione pubblicato nel sito internet del Venditore. A titolo esemplificativo e non esaustivo si riconoscono come Vizi Palesi i difetti superficiali, i difetti di decorazione, di lappatura/levigatura, di calibro, di planarità, di ortogonalità-rettilineità, di spessore, le crepe, le sbecature, i fuori tono, i toni mescolati e i Prodotti che presentano problemi da taglio/scaglie.

G.4.- Nel caso l'Acquirente rilevi Vizi Palesi dovrà fare reclamo al Venditore per iscritto, a pena di decadenza, entro 8 (otto) giorni dal ricevimento e tenere a disposizione del Venditore l'intera partita di materiale. Il reclamo dovrà riportare i dati di fatturazione e una precisa descrizione del vizio reclamato corredata, quando possibile, da immagini fotografiche. Qualora il reclamo dovesse risultare infondato, l'Acquirente si rende disponibile a risarcire il Venditore delle spese sostenute per l'eventuale sopralluogo (perizie, viaggi, ecc).

G.5.- I Vizi Occulti dovranno essere notificati al Venditore mediante lettera raccomandata A.R., a pena di decadenza dalla garanzia, entro 8 (otto) giorni dalla data della scoperta del difetto.

G.6.- L'azione dell'Acquirente diretta a fare valere la garanzia per vizi si prescrive comunque nel termine di 12 (dodici) mesi decorrenti dalla consegna dei Prodotti.

H.- GARANZIA PER VIZI

H.1.- La garanzia del Venditore si intende limitata ai soli Prodotti di prima scelta e non ai Prodotti di seconda o terza scelta o di partite d’occasione con prezzi o sconti particolari quando debitamente segnalati in nota nella Conferma dell’Ordine.

H.2. Il Venditore non garantisce l'idoneità dei Prodotti ad usi particolari, ma soltanto le caratteristiche tecniche pubblicate nel sito internet nel documento 2) Schede tecniche. L'indicazione d’uso, anche quando presentata dal Venditore in cataloghi e manuali, è da ritenersi puramente indicativa.

Sulla base delle caratteristiche tecniche riportate nelle 2) Schede Tecniche è sempre compito del progettista valutare l'idoneità del Prodotto alle condizioni specifiche di utilizzo in funzione delle sollecitazioni e delle variabili che si possono verificare nell’ambiente di destinazione alterandone le sue caratteristiche, a titolo d'esempio, all'intensità del traffico, alla qualità del traffico (calpestio in presenza di sabbia, di detriti...), alle eventuali condizioni climatiche avverse e a qualsiasi altra aleatorietà a cui può essere esposto il materiale.

H.3.- Nel caso risulti accertato che il Prodotto manifesti Vizi Palesi, come definiti al sub lett. G n.3, il Venditore provvederà alla sostituzione del Prodotto difettoso con altro avente caratteristiche pari o superiori o nel caso ciò non sia possibile ad una congrua riduzione del prezzo. In alternativa l'Acquirente avrà diritto, previa restituzione dei Prodotti viziati, al rimborso del prezzo pagato, maggiorato del costo del trasporto, con esclusione del risarcimento di ogni altro danno diretto e/o indiretto.

H.4. La garanzia del Venditore deve ritenersi esclusa nel caso in cui il Prodotto affetto da Vizi Palesi (in tutto o in parte) sia stato utilizzato e/o comunque trasformato dovendosi ritenere che in tal modo l'Acquirente (o il suo cliente) abbia espresso la volontà di accettarli nello stato in cui si trovano.

H.5 Nel caso risulti accertato che il Prodotto manifesti Vizi Occulti, la garanzia del Venditore è limitata alla sostituzione del materiale con altro avente caratteristiche pari o superiori e ove ciò non sia possibile al rimborso del prezzo pagato maggiorato del costo del trasporto. In ogni caso la garanzia del Venditore per ogni danno diretto e/o indiretto comunque originato dal prodotto difettoso, deve intendersi limitata ad una somma che non potrà superare il doppio del prezzo di vendita applicato dal Venditore in relazione alla sola parte della fornitura difettosa.

H.6.- Nel caso l'Acquirente rivenda il Prodotto a soggetti tutelati dal codice del consumo (d.l. n.206/2005) sarà responsabile delle condizioni praticate se difformi da quelle qui riportate e dovrà accertarsi che i diritti del consumatore siano esercitati nel rispetto dei rimedi e dei termini fissati da tale codice. Nel caso sussistano i presupposti, il diritto di regresso e/o comunque di rivalsa spettanti all'Acquirente verso il Venditore/produttore non potrà eccedere le esenzioni ed i limiti come fissati dal sub lett. G n.1 al sub lett. H n.5.

I. CLAUSOLE SOLVE ET REPETE E RISOLUTIVE

I.1.- Ai sensi dell'art. 1462 del Codice Civile, per nessun motivo, ivi compresi pretesi vizi o difetti del materiale, l'Acquirente potrà sospendere o ritardare il pagamento del materiale ritirato, salva naturalmente la facoltà di ripetere quando possa dimostrare di avere indebitamente pagato.

I.2.- Nel caso di mutamento delle condizioni patrimoniali dell'Acquirente o di mancato pagamento anche parziale di prodotti già forniti, il Venditore può sospendere l'esecuzione delle forniture in corso e/o risolvere i contratti in corso senza che l'Acquirente possa rivendicare risarcimenti diretti e/o indiretti di alcun tipo.

L.- PATTO DI RISERVATO DOMINIO

L.1.- Fino a quando l'Acquirente non avrà provveduto all’integrale pagamento del prezzo, i Prodotti oggetto della fornitura rimarranno di proprietà del Venditore.

L.2.- Durante il periodo suddetto, l'Acquirente assumerà gli obblighi e le responsabilità del custode, e non potrà alienare, dare in uso, lasciare sequestrare o pignorare tali Prodotti senza dichiarare la proprietà del Venditore e dare immediato avviso a mezzo raccomandata A.R.

M.- FORZA MAGGIORE

M.1.- Ciascuna parte potrà sospendere l'esecuzione dei suoi obblighi contrattuali quando tale esecuzione sia resa impossibile o oggettivamente troppo onerosa da un impedimento imprevedibile indipendente dalla sua volontà, quale ad esempio: sciopero, boicottaggio, serrata, incendio, guerra (dichiarata o non), guerra civile, sommosse e rivoluzioni, requisizioni, embargo, interruzioni di energia, rotture straordinarie di macchinari, ritardi nella consegna di componenti o materie prime.

M.2.- La parte che desidera avvalersi della presente clausola dovrà comunicare immediatamente per iscritto all'altra parte il verificarsi e la cessazione delle circostanze di forza maggiore.

M.3.- Qualora la sospensione dovuta a forza maggiore duri più di 60 (sessanta) giorni, ciascuna parte avrà il diritto di risolvere il presente contratto, previo un preavviso di 10 (dieci) giorni, da comunicarsi alla controparte per iscritto.

N.- OBBLIGO DI RISERVATEZZA

N.1.- L'Acquirente è tenuto ad osservare la più assoluta riservatezza su tutte le notizie di carattere tecnico (quali, in via meramente esemplificativa, disegni, prospetti, documentazioni, formule e corrispondenza) e di carattere commerciale (ivi comprese le condizioni contrattuali, i prezzi d’acquisto, le condizioni di pagamento ...) apprese in esecuzione del presente Contratto.

N.2.- L'obbligo di riservatezza viene assunto per tutta la durata del Contratto, nonché per il periodo successivo alla sua esecuzione.

N.3.- In ogni caso di inosservanza dell’obbligo di riservatezza, la parte inadempiente è tenuta e risarcire all'altra tutti i danni che ne dovessero derivare.

O.- MARCHI E SEGNI DISTINTIVI DEL VENDITORE

O.1.-L'utilizzo dei marchi, dei modelli ornamentali e delle opere d’ingegno in genere, in qualunque forma o modo di espressione (quali a titolo meramente esemplificativo, ma non esaustivo: immagini, foto, disegni, filmati, figure, strutture, etc.) costituenti proprietà intellettuale del Venditore, attraverso qualsiasi mezzo (quali a titolo meramente esemplificativo, ma non esaustivo: stampa, video, radio, internet, social media, piattaforme di messaggistica istantanea o VoIP, etc.) è severamente vietato. Qualsiasi deroga a tale divieto, anche solamente parziale, dovrà essere autorizzata per iscritto, caso per caso, dalla Direzione generale del Venditore.

P.- LINGUA DEL CONTRATTO, LEGGE APPLICABILE, GIURISDIZIONE E COMPETENZA

P.1.- Il Contratto e le presenti condizioni sono redatti in lingua Italiana, la quale prevarrà nel caso di divergenza con la traduzione in altre lingue.

P.2.- La definizione di qualsiasi controversia comunque relativa alle forniture è soggetta alla legge ed alla giurisdizione dello Stato Italiano e la competenza territoriale viene devoluta in via esclusiva al Tribunale di Modena nella cui circoscrizione il Venditore ha la sua sede legale.

GENERAL CONDITIONS OF SALES / Rev.1a - 1st January 2018

A.- CONTRACT COMPLETION

A.1.- These general sales conditions govern every sales contract between the Seller and the Buyer and any amendment or exception thereof shall be agreed in writing.

A.2.- Any offers, credits and/or rebates granted by agents or other intermediaries, shall not be considered valid if they are not confirmed in writing by the Seller.

A.3.- The Buyer shall send the written orders to the Seller, directly or through the agents, and the orders shall include the codes of the required products, quantity, price and destination. The order sent by the Buyer is irrevocable.

A.4.- The sale shall be deemed completed when: (i) the Buyer receives a written confirmation from the Seller, via e-mail, fax or other electronic means, that complies with the terms and conditions of the order; or (ii) if the confirmation sent by the Seller contains conditions that differ from the order sent by the Buyer, when the latter accepts it in writing or in any case does not object within 7 (seven) days from reception; or (iii) if the Seller does not provide a written confirmation, when the products are delivered and loaded by the Buyer.

B.- PRICES

B.1.- The prices agreed upon for each individual sale are net prices for cash delivery ex works (the Seller's plant shall be specified in the order confirmation), unless otherwise agreed in writing.

C.- PRODUCT CHARACTERISTICS

C.1.- The Buyer declares to have read and comply with the content of the following documentation published on the corporate website: 1) Laying, use, cleaning and maintenance manual and 2) Technical data sheets.

C.2. Given the intrinsic variability of the ceramic products, the characteristics of the samples, previously sent by the Seller to the Buyer, are purely illustrative and cannot be deemed binding.

C.3. Unless specifically requested and agreed before the order confirmation, the Seller does not guarantee that the entire quantity of an article on order shall be sent from one same production lot.

D.- DELIVERY TERMS

D.1.- The delivery terms are approximate and a delay does not give the Buyer any right to claim compensation, without any exception.

D.2.- If the Buyer does not collect the goods, after 10 (ten) days from the date of the "goods ready" notice, the Seller has the right – at its discretion – to establish a new delivery date.

E.- SHIPPING ARRANGEMENTS AND TERMS

E.1.- The Buyer must communicate any variation in the destination of the products, different from the one agreed in the order confirmation, in writing within, and no later than, the second day before the day foreseen for the collection at the Seller's premises. The Seller reserves the right not to accept the change of the product destination. If the actual destination of the product is different from the one stated by the Buyer, the Seller reserves the right to suspend the execution of the supplies underway and/or to terminate the contracts in force and the Buyer shall not have the right to claim direct and/or indirect compensation of any type.

E.2.- Unless otherwise agreed, the goods shall be delivered ex-works (EXW - Incoterms 2010) and this shall also be the case when the parties agree that the delivery, or part of it, shall be arranged by the Seller on the Buyer's behalf. In any case, the risks shall transfer to the Buyer upon delivery to the first carrier.

E.3.- Without prejudice to the Seller's extraneity in relation to the transport contract, the Seller shall not be indicated as "shipper" on the bill of lading. The communication of the gross weight of the container to the Forwarding agent does not represent in any way the undertaking of any liability by the Seller as regards the SOLAS (Safety Of Life At Sea) Convention. In no event may the said communication be taken to be the VGM (Verified Gross Mass).

E.4.- The Buyer undertakes to ensure that the vehicle sent to the Seller's warehouse is suitable for the loading operations, considering the nature of the products. If the vehicle sent to collect the goods causes difficulties in the loading operations, the Seller reserves the right to charge a penalty, of 4% of the value of the products, to cover the extra logistics costs. If the vehicle sent is not at all suitable, the Seller reserves the right to refuse to load the goods and the Buyer shall not have the right to claim compensation for any direct and/or indirect cost that may arise therefrom.

E.5.- The Buyer is responsible for assigning the carrier the task of checking the products before loading them; any observations concerning the condition of the packaging and the correspondence of the quantities loaded with those on the transport document must be made by the carrier upon collection of the goods. The said observations must be written on all the copies of the transport documents, otherwise the loaded products shall be considered to be complete and in good condition. As a result, the Seller shall not be liable for any missing or damaged products not reported by the carrier.

E.6.- The Buyer is also responsible for assigning the carrier the task of checking the loading procedure and the stability of the goods on the vehicle, in order to prevent damage during transport and to comply with all road safety provisions.

F.- PAYMENTS

F.1.- All payments must be made to the Seller's registered office. Payments made to agents, representatives, or sales assistants shall not be considered as made until the amounts are received by the Seller.

F.2.- The Buyer shall not fulfil its payment obligations by making payments from countries other than its own country of residence, if the said countries do not guarantee an adequate exchange of information with Italy. In case of breach of the said prohibition, the Seller has the right to terminate the contract for just cause and the Buyer shall not have the right to claim compensation for any damage suffered.

F.3.- Any costs for stamp duty and bank draft fees shall be borne by the Buyer. Failure to fulfil, even only in part, the payment shall result in the application of interest on arrears in favour of the Seller, from the date established for the payment, as envisaged by legislative decree 09/10/2002 no. 231.

F.4.- Unless otherwise agreed in writing, the Buyer undertakes not to offset any receivables, of whatever nature, owed by the Seller.

G.- CLAIMS

G.1.- Upon receipt of the products, the Buyer shall perform a visual inspection in compliance with instructions provided in point 7 of UNI EN ISO 10545-2 standards.

G.2.- The products must be installed and fitted strictly respecting the recommendations related to the activities to be performed before and during the laying of the product specified in document 1) Laying, use, cleaning and maintenance manual, published on the Seller's website, and on the product packaging and/or inside the packaging. Faults caused by an incorrect installation and by missing/incorrect maintenance (different from instructions provided in document 1) Laying, use, cleaning and maintenance manual), by an unsuitable use and/or by normal wear over time shall not be considered product faults.

G.3.- With the exception of the limits of acceptability foreseen by the international EN 14411 (ISO 13006) standard, the parties acknowledge as identifiable faults those product defects that are immediately visible upon receipt thereof and that make the material unsuitable for use or that significantly reduce its value. This category includes faults as defined in the document 1) Laying, use, cleaning and maintenance manual, published on the Seller's website. Identifiable faults include, by way of a non-limiting example, superficial defects, decoration defects, defects concerning polishing, dimensions, surface flatness, straightness of sides/rectangularity and thickness, cracks, chippings or rough edges, non-compliant shades, mixed shades and products that feature problems deriving from the cutting process and/or from chips.

G.4.- If the Buyer finds an identifiable fault, it must be reported in writing to the Seller, within 8 (eight) days from receipt of the products; failure to send the claim shall result in the forfeiture and loss of such right. The Buyer shall keep the entire lot of material readily available for the Seller. The claim shall include the invoice details and an accurate description of the claimed fault together with photographs, where possible. In the event that the claim proves to be unfounded, the Buyer shall refund the Seller any costs incurred for an inspection (expert's reports, travel, etc.).

G.5.- Hidden faults shall be notified to the Supplier in writing, by recorded delivery letter with advice of receipt, within 8 days from the date such fault is found, under penalty of forfeiture.

G.6.- The Buyer's right to make a claim for faults under warranty is valid for 12 (twelve) months from the delivery of the products.

H.- WARRANTY FOR FAULTS

H.1.- The Seller's warranty is limited to first grade products and not second or third grade products or lots on offer with special prices or discounts, which must be duly specified with a note in the order confirmation.

H.2. The Seller does not guarantee the suitability of the products for particular uses, and only guarantees the technical specifications published on the website in the document 2) Technical data sheets. The indication for use is merely indicative, even when written in the Seller's catalogues and manuals. On the basis of the characteristics described in the document 2) Technical data sheets, the designer always has the task of assessing the suitability of the product for the specific use conditions, taking into account the stress and variables to which the product will be subjected, which may alter its characteristics; for example, the traffic intensity, quality of traffic (foot traffic with the presence of sand, debris...), adverse weather conditions and any other unpredictable factor to which the material may be exposed.

H.3.- In the event that identifiable product faults are ascertained, as defined in sub section G no. 3, the Seller shall replace the faulty product with another one with equal or superior characteristics; should this not be possible, the Seller shall apply a significant price reduction. Alternatively, following the return of the faulty products, the Buyer shall have the right to a refund of the price paid plus the transport cost, with the exclusion of compensation for any other direct and/or indirect damage.

H.4. The Seller's warranty shall not be valid if the products that have identifiable faults (totally or in part) have been used and/or in any case transformed, as this entails that the Buyer (or its customer) expressed the intention to accept them in the condition in which they were found.

H.5.- In the event that hidden product faults are ascertained, the Seller's warranty is limited to the replacement with other products of equal or superior characteristics; should this not be possible the Seller shall refund the price paid plus the transport cost. In any case, the Seller's warranty for any direct and/or indirect damage caused by the faulty product, shall be limited to an amount that shall not be greater than double the selling price applied by the Seller, only in relation to the faulty part of the supply.

H.6.- In the event that the Buyer resells the product to subjects protected by the consumer code (law decree no. 206/2005), the former shall be responsible for the conditions applied, if different from those stated herein, and shall ensure that the consumer's rights are exercised, in relation to the remedies and terms established by the said code. If there are the grounds for the Buyer to exercise the right of recourse and/or make a claim against the Seller/manufacturer, the said action shall take into account or go beyond the exemptions and limits established in sub sections G no. 1 and H no. 5.

I. SOLVE ET REPETE (pay and then claim) AND TERMINATION CLAUSES

I.1.- Pursuant to article 1462 of the Italian Civil Code, on no account may the Buyer suspend or delay payment of collected material, including in the event of alleged defects or faults in the material; this does not affect the right to claim back any payments made unduly (solve et repete).

I.2.- If the Buyer's financial situation changes or in the event of non-payment (even partial) of products already supplied, the Seller reserves the right to suspend the execution of the supplies underway and/or to terminate the contracts in force and the Buyer shall not have the right to claim direct and/or indirect compensation of any type.

L.- RETENTION OF OWNERSHIP

L.1.- The products supplied shall remain exclusive property of the Seller until the Buyer has paid the full amount.

L.2.- During the aforementioned period, the Buyer shall undertake the obligations and responsibilities as bailee (also referred to as custodian) and shall not transfer the said products, grant their use, let them be seized or distrained without declaring that the property is of the Seller, and the Buyer shall immediately inform the Seller by recorded delivery letter with advice of receipt.

M.- FORCE MAJEURE

M.1.- Each party may suspend the fulfilment of its contractual obligations, when the said fulfilment is impossible or objectively too costly due to an unforeseeable impediment independent from the parties, such as for example: strike, boycott, lockout, fire, war (declared or not), civil war, riots and revolutions, requisitions, embargo, power blackouts, extraordinary breakage of machinery, delays in the delivery of components or raw materials.

M.2.- The party that wishes to apply this clause shall immediately notify the onset and end of the circumstances of force majeure to the other party in writing.

M.3.- If the suspension due to force majeure lasts longer than 60 (sixty) days, each party shall have the right to terminate this contract, with a notice of 10 (ten) days to be notified to the counterparty in writing.

N.- CONFIDENTIALITY

N.1.- The Buyer undertakes to maintain confidentiality as regards all information of a technical (such as, by way of a non-limiting example, drawings, tables, documentation, formulas and correspondence) and commercial nature (including contractual conditions, purchase prices, payment conditions,...) gained during the performance of this contract.

N.2.- The confidentiality obligation shall be undertaken for the entire duration of this contract and for the period following its execution.

N.3.- In case of failure to uphold the confidentiality obligation, the non-fulfilling party shall pay the other party compensation for all damages that may derive therefrom.

O.- SELLER'S TRADEMARKS AND DISTINCTIVE SIGNS

O.1.-The use of trademarks, ornamental designs and creative works in general, in whatever form and manner of expression (such as, by way of a non-limiting example: images, photos, drawings, videos, shapes, structures, etc.) constituting the Seller's intellectual property, through any means (such as, by way of a non-limiting example: press, video, radio, internet, social media, instant messaging platforms or VoIP, etc.) is strictly forbidden. Any exception to the said prohibition, even only partial, must be authorised in writing, each time, by the Seller's general management.

P.- CONTRACT LANGUAGE, APPLICABLE LAW, JURISDICTION AND AUTHORITY

P.1.- The present CONTRACT is drafted in Italian, and in case of disputes the said version shall prevail over any translations in other languages.

P.2.- Any dispute concerning the supply of products shall be subject to Italian law and jurisdiction and the Court of Modena, the town in which the Seller has its registered office, shall have sole local jurisdiction.

CONDITIONS GÉNÉRALES DE VENTE / Rév.1a - 01 Janvier 2018

A.- MODALITÉS DE CONCLUSION DU CONTRAT

A.1.- Les présentes Conditions Générales de Vente régissent tout contrat de Vente entre le Vendeur et l’Acheteur et toute modification ou dérogation de ces dernières doit être convenue par écrit.

A.2.- D'éventuelles offres, accréditations et / ou ristournes accordées par des agents ou par d’autres intermédiaires, ne seront réputées valables que si elles sont confirmées par écrit par le Vendeur.

A.3.- L’Acheteur envoie au Vendeur, directement ou par l’intermédiaire d’agents, des Commandes écrites qui doivent indiquer les codes des Produits demandés, les quantités, leur prix et leur destination. La commande envoyée par l’Acheteur est irrévocable.

A.4.- La Vente doit être réputée conclue au moment où : (i) l’Acheteur reçoit de la part du Vendeur une Confirmation écrite par e-mail, par télécopie ou par d’autres moyens télématiques, conforme aux conditions de la Commande ; ou (ii) en cas de Confirmation envoyée par le Vendeur contenant des conditions différant de la Commande envoyée par l’Acheteur lorsque celui-ci l’accepte par écrit ou quoi qu’il en soit s’il ne la conteste pas dans un délai de 7 (sept) jours à compter de la réception ; ou (iii) en l’absence d’une confirmation écrite de la part du Vendeur, au moment où les Produits seront livrés et chargés par l’Acheteur.

B.- PRIX

B.1.- Sauf accord contraire, les prix de vente convenus au fur et à mesure sont réputés nets, pour les paiements en espèces et les livraisons Franco l'établissement du Vendeur indiqué sur la Confirmation de Commande.

C.- CARACTÉRISTIQUES DES PRODUITS

C.1.- L’Acheteur déclare avoir lu et s’en tenir au contenu de la documentation suivante publiée sur le site Internet de la société: 1) Manuel de Pose, d’Utilisation, de Nettoyage et d’Entretien et 2) Fiches techniques.

C.2. Vu la variabilité intrinsèque du produit en céramique, les caractéristiques des échantillons et / ou des modèles envoyés précédemment par le Vendeur à l’Acheteur sont indicatifs et non contraignants.

C.3. Sauf en cas de demandes spécifiques à convenir avant la Confirmation de Commande, le Vendeur ne garantit pas la commande d’un article soit intégralement constituée par un même lot de production.

D.- DÉLAIS DE LIVRAISON

D.1.- Les délais de livraison s'entendent fournis à titre indicatif et leur prorogation ne donne en aucun cas le droit à l’Acheteur de demander des indemnisations, excluant dès à présent toute exception.

D.2.- Si l’Acheteur ne retire pas le matériel, au bout d’un délai de 10 (dix) jours à compter de la date de l’annonce indiquant que la marchandise est prête, le Vendeur se réserve la faculté de fixer à sa discrétion un nouveau délai de livraison.

E.- LIVRAISON ET EXPÉDITION

E.1.- L'éventuelle variation de la destination des Produits, différente de celle convenue dans la Confirmation de Commande, doit être communiquée par l’Acheteur par écrit au plus tard le second jour qui précède le jour du retrait au siège du Vendeur. Le Vendeur se réserve la faculté de ne pas accepter la variation de la destination des Produits. Au cas où la destination effective du Produit serait différente de celle déclarée par l’Acheteur, le Vendeur se réserve la faculté de suspendre l’exécution des fournitures en cours et / ou de résilier le contrat sans que l’Acheteur puisse revendiquer des indemnisations directes et / ou indirectes d’aucune sorte.

E.2.- Sauf accord contraire, la fourniture de la marchandise est livrée Départ Usine (EXW aux termes des Incoterms 2010) même si l’on a convenu que l’expédition ou une partie de cette dernière sera suivie par le Vendeur sur mandat de l’Acheteur. En tout état de cause, les risques passent à l’Acheteur au plus tard au moment de la livraison au premier transporteur.

E.3.- Sans préjudice du désintérêt du Vendeur par rapport au contrat de transport, celui-ci ne pourra être indiqué comme le “shipper” dans le connaissance. La communication du poids brut du container à l’expéditeur, ne constitue pas une prise de responsabilité de la part du Vendeur aux fins de la Convention SOLAS (Safety Of Life At Sea). En aucun cas cette communication ne pourra être considérée comme le VGM (Verified Gross Mass).

E.4.- L’Acheteur s’engage à ce que le véhicule envoyé aux entrepôts du Vendeur soit compatible avec la nature des Produits à charger. Si le véhicule qui se présente comporte des difficultés significatives pour les opérations de chargement, le Vendeur se réserve la faculté de débiter une pénalité de l’ordre de 4 % de la valeur des produits pour couvrir les coûts logistiques supplémentaires. Si le véhicule convenu n'est absolument pas compatible, le Vendeur se réserve la faculté de refuser les opérations de chargement sans que l’Acheteur ne puisse rien lui demander à titre de remboursement de toute dépense directe et / ou indirecte éventuelle.

E.5.- Il appartient à l’Acheteur de charger le transporteur de contrôler les produits avant le chargement ; d’éventuelles observations concernant l’intégrité des emballages et la correspondance des quantités chargées avec celles indiquées sur le document de transport doivent être soulevées par le transporteur au moment du chargement. Ces observations doivent être indiquées sur toutes les copies des documents de transport ; dans le cas contraire, les produits chargés sont réputés intacts et complets. Il s'ensuit que le Vendeur décline toute responsabilité en cas d’absence ou de détérioration des produits non signalée par le transporteur.

E.6.- L’Acheteur a également la responsabilité de charger le transporteur de vérifier les modalités et la stabilité du chargement sur le véhicule afin d’éviter les bris durant le transport et le respect de toutes les dispositions de sécurité concernant la circulation sur route.

F.- PAIEMENTS

F.1.- Toute obligation de paiement doit être accomplie au siège légal du Vendeur. Les éventuels paiements remis à des agents, à des représentants ou à des auxiliaires de commerce ne seront réputés effectués qu’au moment où le Vendeur percevra les sommes correspondantes.

F.2.- Il est interdit à l’Acheteur d’effectuer des paiements depuis un pays différent de son pays de résidence et ne garantissant pas un échange d’informations correct avec l’Italie. En cas de violation de cette interdiction, le Vendeur a la faculté de résilier le contrat pour juste cause sans que l’Acheteur ne puisse revendiquer le droit d’obtenir une quelconque réparation pour l’éventuel préjudice subi.

F.3.- Les éventuels frais de timbre et d’encaissement d’effets et de traites sont à la charge de l’Acheteur. En cas de défaillance, même partielle, des intérêts de retard commencent à courir en faveur du Vendeur, à compter du jour fixé pour le paiement, dans la mesure prévue par le Décret Législatif italien n° 231 du 09/10/2002.

F.4.- Sauf accord écrit contraire, l’Acheteur s’engage à ne compenser aucune créance échue.

G.- RÉCLAMATIONS

G.1.- À la réception des Produits, l’Acheteur devra soumettre ces derniers à un contrôle minutieux moyennant un examen visuel effectué conformément aux indications du point 7 des normes UNI EN ISO 10545-2.

G.2.- L’installation et la pose des Produits doivent être effectuées en suivant scrupuleusement les recommandations inhérentes aux activités exercées avant et durant la pose indiquées sur le document 1) Manuel de Pose, d’Utilisation, de Nettoyage et d’Entretien, publié sur le site Internet du Vendeur ainsi qu’à l’extérieur et/ou à l’intérieur de l’emballage du produit. Les défauts dus à une installation erronée et à un entretien absent / erroné (ne respectant pas les indications fournies dans le 1) Manuel de Pose, d’Utilisation, de Nettoyage et d’Entretien), par un usage prévu inapproprié et / ou par l’usure normale due au temps ne sont pas considérés comme des vices du Produit.

G.3.- Sous réserve des limites d’acceptabilité prévues par la norme internationale EN 14411 (ISO 13006), les Parties reconnaissent comme des Vices Évidents les défauts des Produits existant dès la réception de sorte que le matériel devienne inutilisable ou qu’il perde une grande partie de sa valeur. Cette catégorie comprend les défauts définis dans le document 1) Manuel de Pose, d’Utilisation, de Nettoyage et d’Entretien publié sur le site Internet du Vendeur. À titre d’exemple non contraignant, on reconnaît comme des Vices Évidents les défauts de surface, de décoration, de polissage, de calibre,

de planéité, d’orthogonalité–rectitude, d’épaisseur, les fissures, les ébréchés, les hors nuance, les nuances mélangées et les Produits qui présentent des problèmes de coupe - voile.

G.4.- Si l’Acheteur relève des Vices Évidents, il devra présenter une réclamation écrite au Vendeur, sous peine de déchéance, dans un délai de 8 (huit) jours à compter de la réception et tenir le lot complet de matériel à la disposition de ce dernier. La réclamation devra indiquer les données de facturation et une description précise du vice objet de la réclamation, accompagnée, si possible, de photographies. Si la réclamation devait s’avérer sans fondement, l’Acheteur est disposé à rembourser au Vendeur les dépenses encourues pour l’éventuelle visite des lieux (expertises, déplacements, etc.).

G.5.- Les Vices Cachés devront être notifiés au Vendeur par lettre recommandée avec avis de réception, sous peine d’annulation de la garantie, dans un délai de 8 (huit) jours à compter de la date de la découverte du défaut.

G.6.- L’action de l’Acheteur ayant pour but de faire valoir la garantie en cas de vices se prescrit dans un délai de 12 (douze) mois à compter de la livraison des Produits.

H.- GARANTIE COUVRANT LES VICES

H.1. La garantie du Vendeur est réputée limitée aux seuls Produits de premier choix et non aux Produits de second ou de troisième choix ou à des lots d’occasion auquel on applique des prix ou des remises particuliers lorsqu’ils sont dûment signalés dans les notes de la Confirmation de Commande.

H.2. Le Vendeur ne garantit pas l’adéquation des Produits à des usages particuliers, mais uniquement les caractéristiques techniques publiées sur le site Internet dans le document 2) Fiches techniques. L’usage indiqué, également lorsqu’il est présenté par le Vendeur dans des catalogues et des manuels, est purement indicatif. Sur la base des caractéristiques techniques indiquées dans les 2) Fiches Techniques, le concepteur a toujours le devoir d’évaluer l’adéquation du Produit aux conditions spécifiques d’utilisation en fonction des contraintes et des variables pouvant se vérifier dans le lieu de destination et susceptibles d’en altérer les caractéristiques, par exemple, l’intensité et la qualité de la circulation (piétinement en présence de sable, de détritrus...), ainsi que les éventuelles conditions climatiques défavorables et toute autre incidence à laquelle peut être exposé le matériel.

H.3.- Si l’on a constaté que le Produit présente les Vices Évidents définis à la lettre G n°3, le Vendeur remplacera le Produit défectueux par un autre produit ayant des caractéristiques analogues ou supérieures ou, lorsque cela est impossible, à une réduction cohérente du prix. En alternative, l’Acheteur aura droit, après la restitution des Produits défectueux, au remboursement du prix payé, majoré du prix du transport, à l’exclusion du remboursement de tout autre préjudice direct et / ou indirect.

H.4. La garantie du Vendeur doit être réputée exclue au cas où le Produit présentant des Vices Évidents (entièrement ou partiellement) aurait été utilisé et / ou du moins transformé ; dans ce cas, on considérera que l’Acheteur (ou son client) a exprimé la volonté de les accepter en l’état.

H.5 Si l’on a constaté que le Produit présente des Vices Cachés, la garantie du Vendeur se limite au remplacement du matériel par du matériel ayant des caractéristiques analogues ou supérieures et, lorsque cela est impossible, au remboursement du prix payé majoré des frais de transport. En tout état de cause, la garantie du Vendeur couvrant tout dommage direct et / ou indirect causé par le produit défectueux, se limitera à une somme qui ne pourra pas dépasser le double du prix de vente appliqué par le Vendeur dans le cadre de la seule partie de la fourniture défectueuse.

H.6.- Si l’Acheteur revend le Produit à des clients protégés par le code de la consommation (Décret–loi italien n° 206/2005) il sera responsable des conditions appliquées si celles-ci diffèrent des conditions indiquées ici et il devra s’assurer que les droits du consommateur sont exercés dans le respect des remèdes et des délais fixés par ce code. Si les conditions sont réunies, le droit de retrait et / ou de recours revenant à l’Acheteur à l’encontre du Vendeur / fabricant ne pourra dépasser ni les exonérations ni les limites établies de la lettre G n°1 à la lettre H n°5.

I. CLAUSES SOLVE ET REPETE ET CLAUSES RÉSOLUTOIRES

I.1.- Aux termes de l’art. 1462 du Code Civil italien, en aucun cas, y compris les prétendus vices ou défauts du matériel, l’Acheteur ne pourra suspendre ou retarder le paiement du matériel retiré, sans préjudice naturellement de la faculté d’exiger lorsqu’il est en mesure de démontrer avoir indûment payé.

I.1.- En cas de variation des conditions patrimoniales de l’Acheteur ou de non-paiement même partiel de produits déjà fournis, le Vendeur se réserve la faculté de suspendre l’exécution des fournitures en cours et / ou de résilier les contrats sans que l’Acheteur ne puisse revendiquer des indemnisations directes et / ou indirectes d’aucune sorte.

L.- PACTE DE RÉSERVE DE PROPRIÉTÉ

L.1.- Tant que l’Acheteur n’aura pas intégralement payé le prix, les Produits objet de la fourniture resteront la propriété du Vendeur.

L.2.- Au cours de la susdite période, l’Acheteur assumera les obligations et les responsabilités de gardien, et il ne pourra ni aliéner, ni confier, ni permettre la saisie desdits Produits sans déclarer la propriété du Vendeur et informer immédiatement ce dernier par lettre recommandée avec avis de réception.

M.- FORCE MAJEURE

M.1.- Chacune des parties pourra suspendre l’accomplissement de ses obligations contractuelles lorsque cette exécution est rendue impossible ou objectivement trop onéreuse par un empêchement imprévisible indépendant de sa volonté comme : les grèves, les boycottages, les lock-outs, les incendies, les guerres (déclarées ou non), les guerres civiles, les révoltes et les révolutions, les réquisitions, les embargos, les coupures de courant, les ruptures exceptionnelles de machines, les retards de livraison de composants ou de matières premières.

M.2.- La partie qui souhaite user de la présente clause devra communiquer immédiatement par écrit à l’autre partie la survenue et la cessation des circonstances de force majeure.

M.3.- Si la suspension due à une force majeure dure plus de 60 (soixante) jours, chacune des parties aura le droit de résilier le présent contrat, avec un préavis de 10 (dix) jours, en le communiquant par écrit à la partie adverse.

N.- OBLIGATIONS DE CONFIDENTIALITÉ

N.1.- L’Acheteur est tenu d’observer le secret le plus absolu concernant toutes les informations de caractère technique (comme, par exemple, les dessins, les notices, les documentations, les formules et la correspondance) et de caractère commercial (y compris les conditions contractuelles, les prix d’achat, les conditions de paiement, etc.) dont il aurait eu connaissance durant l’exécution du présent Contrat.

N.2.- L’obligation de confidentialité est assumée pendant toute la durée du Contrat, ainsi que pour la période successive à son exécution.

N.3.- Dans tous cas de non–observation de l’obligation de confidentialité, la partie défaillante est tenue de réparer à l’autre partie tous les éventuels préjudices.

O.- MARQUES ET SIGNES DISTINCTIFS DU VENDEUR

O.1.- L’utilisation des marques, des modèles ornementaux et des œuvres de l’esprit en général, sous quelque forme ou suivant quelque modalité d’expression que ce soit (à titre d’exemple, non contraignant : les images, les photos, les dessins, les vidéos, les figures, les structures, etc.) constituant la propriété intellectuelle du Vendeur, à travers tout moyen (à titre d’exemple non contraignant : l’impression, la vidéo, la radio, Internet, les médias sociaux, les plates-formes de messagerie instantanée ou VoIP, etc.) est formellement interdite. Toute dérogation à cette interdiction, même partielle, devra être autorisée par écrit, cas par cas, par la Direction générale du Vendeur.

P.- LANGUE DU CONTRAT, LOI APPLICABLE, JURIDICTION ET COMPÉTENCE

P.1.- Le Contrat et les présentes conditions sont rédigés en langue italienne qui prévaudra en cas de divergence avec la traduction dans d’autres langues.

P.2.- La définition de toute controverse relative aux fournitures est régie par la loi et la juridiction de l’État italien et les parties reconnaissent la compétence territoriale exclusive du Tribunal de Modène dans la circonscription duquel se trouve le siège légal du Vendeur.

ALLGEMEINE VERKAUFSBEDINGUNGEN / Fassung.1a - 01 Januar 2018

A.- MODALITÄT DES VERTRAGSABSCHLUSSES

A.1.- Die vorliegenden Allgemeinen Verkaufsbedingunen regeln alle Verträge zwischen dem Verkäufer und dem Käufer und alle Änderungen oder Abweichungen davon müssen schriftlich vereinbart werden.

A.2.- Eventuelle Angebote sowie mit Handelsvertretern oder sonstigen Vermittlern vereinbarten Gutschriften sind nicht verbindlich, es sei denn, sie werden vom Verkäufer schriftlich bestätigt.

A.3.- Der Käufer sendet dem Verkäufer direkt oder über Handelsvertreter schriftliche Bestellungen zu, die die Angabe der Artikelnummern der gewünschten Produkte, der Mengen, ihres Preises und der Bestimmung enthalten müssen. Die vom Käufer gesendete Bestellung ist unwiderruflich.

A.4.- Der Verkauf gilt zu dem Zeitpunkt als abgeschlossen, an dem: (i) der Käufer vom Verkäufer eine schriftliche Bestätigung per E-Mal, Fax oder auf sonstigem Weg erhält, die den Fristen und Bedingungen der Bestellung entspricht; oder (ii) falls die vom Verkäufer gesendete Bestätigung, Bedingungen enthält, die von der vom Käufer erhaltenen Bestellung abweichen, wenn dieser diese akzeptiert oder nicht innerhalb von 7 (sieben) Tagen ab ihrem Empfang beanstandet; oder (iii) falls keine schriftliche Bestätigung durch den Verkäufer erfolgt, zu dem Zeitpunkt, an dem die Produkte geliefert und vom Käufer übernommen werden.

B.- PREISE

B.1.- Vorbehaltlich abweichender schriftlicher Vereinbarungen gelten die von Mal zu Mal vereinbarten Verkaufspreise als Nettobarpreise bar mit Lieferung frei ab dem in der Auftragsbestätigung angegebenen Werk des Verkäufers.

C.- EIGENSCHAFTEN DER PRODUKTE

C.1.- Der Käufer erklärt, die folgende auf der Web-Site des Unternehmen veröffentlichte Dokumentation zur Kenntnis genommen zu haben und sich an deren Inhalt zu halten: 1) Handbuch zur Verlegung, Benutzung, Reinigung und Pflege, und 2) Technische Datenblätter.

C.2.- Aufgrund der intrinsischen Variabilität des Keramikprodukts sind die Eigenschaften der vorausgehend vom Verkäufer an den Käufer gesendeten Warenmuster und/oder Modelle hinweisend und unverbindlich.

C.3. Vorbehaltlich spezifischer Vereinbarungen vor der Auftragsbestätigung garantiert der Verkäufer nicht, dass die Lieferung des einzelnen Artikels vollständig mit dem gleichen Produktionslos ausgeführt wird.

D.- LIEFERFRISTEN

D.1.- Die Lieferfristen sind unverbindlich und Verzögerungen führen für den Käufer in keinem Fall zum Anspruch auf Schadensvergütung.

D.2.- Falls der Käufer das Material nicht innerhalb von 10 (zehn) Tagen ab dem Datum der Bereitstellung der Waren abholt, behält sich der Verkäufer das Recht vor, eine neue Lieferfrist festzusetzen.

E.- RÜCKLIEFERUNG UND VERSAND

E.1.- Die eventuelle Änderung des Bestimmungsortes der Produkte, die sich von der in der Auftragsbestätigung vereinbarten unterscheidet, muss vom Käufer schriftlich innerhalb des zweiten Tags vor dem für die Abholung am Sitz des Verkäufers vorgesehenen mitgeteilt werden. Der Verkäufer behält sich das Recht vor, die Änderung der Bestimmung der Produkte nicht zu akzeptieren. Falls sich herausstellt, dass die effektive Bestimmung des Produkts von der vom Käufer angegebenen verschieden ist, behält sich der Verkäufer das Recht vor, die laufenden Lieferungen nicht auszuführen und/ oder die laufenden Verträge aufzulösen, ohne dass der Käufer jeglichen Anspruch auf Entschädigung geltend machen kann.

E.2.- Vorbehaltlich abweichender Vereinbarungen erfolgt die Lieferung der Ware frei ab Werk (EXW gemäß den Incoterms 2010), und dies auch, falls vereinbart wird, dass der Versand oder ein Teil desselben im Auftrag des Käufers durch den Verkäufer erfolgt. In jedem Fall gehen die Risiken spätestens mit der Übergabe an das erste Transportunternehmen an den Käufer über.

E.3.- Unter Beibehaltung der Nichtbeteiligung des Verkäufers am Transportvertrag kann der Verkäufer in der Police der Ladung als „Shipper“ angegeben werden. Die Mitteilung des Bruttogewichts des Containers an den Transportunternehmer stellt keine Übernahme der Verantwortung des Verkäufers hinsichtlich der SOLAS-Konvention dar (Safety Of Life At Sea). In keinem Fall kann diese Mitteilung als VGM (Verified Gross Mass) verstanden werden.

E.4.- Der Käufer verpflichtet sich sicherzustellen, dass das zu den Lagern des Verkäufers gesendete Fahrzeug unter Berücksichtigung der Natur der Produkte für das Laden geeignet ist. Falls das zum Laden gesendete Fahrzeug größere Probleme beim Beladen bereitet, behält der Verkäufer sich das Recht vor, zur Abdeckung der höheren Logistikkosten eine Vertragsstrafe in Höhe von 4 % des Werts der Produkte zu erheben. Falls das Fahrzeug vollkommen ungeeignet ist, behält sich der Verkäufer das Recht vor, das Verladen zu verweigern, ohne dass der Käufer einen Anspruch auf Vergütung der Schäden geltend machen kann, die direkt und/oder indirekt daraus entstehen können.

E.5.- Es ist Aufgabe des Käufers, das Transportunternehmen zu beauftragen und die Produkte vor dem Laden zu kontrollieren; eventuelle Anmerkungen zur Unversehrtheit der Verpackungen und der Übereinstimmung der geladenen Menge mit der in den Transportpapieren angegebenen müssen vom Transportunternehmen zum Zeitpunkt des Ladens vorgenommen werden. Diese Anmerkungen müssen auf alle Exemplaren der Transportpapiere vermerkt werden, anderenfalls gelten die geladenen Produkte als unbeschädigt und vollständig. Daraus folgt, dass der Verkäufer keinerlei Haftung für Fehlmengen oder Beschädigungen der Produkte übernimmt, die vom Transportunternehmen nicht gemeldet werden.

E.6.- Es ist ebenfalls Aufgabe des Käufers, das Transportunternehmen zu beauftragen und die Modalität und die Stabilität des Ladens auf das Fahrzeug zu überprüfen, damit es während des Transports nicht zu Brüchen kommt, sowie die Einhaltung der Sicherheitsbestimmungen der Straßenverkehrsordnung zu gewährleisten.

F.- ZAHLUNGEN

F.1.- Alle Zahlungsverpflichtung müssen am Firmensitz des Verkäufers erfüllt werden. Eventuelle Zahlungen an Handelsvertreter oder Außendienstmitarbeiter gelten als nicht geleistet, bis sie beim Verkäufer eingehen.

F.2.- Es ist dem Käufer untersagt, die Zahlungen aus Ländern vorzunehmen, die vom Land seines Firmensitzes verschieden sind, falls diese Länder keinen angemessenen Informationsaustausch mit Italien gewährleisten. Im Fall der Verletzung dieses Verbots hat der Verkäufer das Recht, den Vertrag aus gutem Grund aufzulösen, ohne dass der Käufer eine Vergütung des entstandenen Schadens geltend machen kann.

F.3.- Eventuelle Kosten und Gebühren für die Einziehung von Effekten und Wechseln gehen zu Lasten des Käufers. Im Fall der Nichteinhaltung des für die Zahlung festgesetzten Tags - auch nur partiell - fallen Säumniszinsen zu Gunsten des Verkäufers an, in der vom ital. Gesetzerlass vom 9. Oktober 2002, Nr. 231 vorgesehenen Höhe.

F.4.- Vorbehaltlich abweichender schriftlicher Vereinbarungen verpflichtet sich der Käufer, keine Guthaben gegenüber dem Verkäufer zu verrechnen.

G.- BEANSTANDUNGEN

G.1.- Beim Empfang der Produkte muss der Käufer sie einer sorgfältigen Sichtkontrolle gemäß den Angaben von Punkt 7 der Normen UNI EN ISO 10545-2 unterziehen.

G.2.- Die Installation und die Verlegung der Produkte müssen unter Einhaltung der Empfehlungen zu den Arbeiten ausgeführt werden, die vor und während der Verlegung ausgeführt werden müssen, wie angegeben im Dokument 1) Handbuch zur Verlegung, Verwendung, Reinigung und Pflege, veröffentlicht auf der Web-Site des Verkäufers und angegeben auf der Verpackung des Produkts und/oder im Inneren derselben. Schäden, die durch eine falsche Installation, Verlegung und durch eine unterlassene/falsche Pflege (abweichend von den Angaben in 1) Handbuch zur Verlegung, Reinigung und Wartung), durch eine ungeeignete Gebrauchsbestimmung oder durch normale Abnutzung verursacht werden, werden nicht als Mängel des Produkts anerkannt.

G.3.- Vorbehaltlich der Grenzen der Akzeptabilität, die von der internationalen Norm EN 14411 (ISO 13006) vorgesehen sind, erkennen die Parteien Mängel der Produkte als offensichtliche Mängel an, die bereits bei ihrem Empfang festgestellt werden können, die das Material zur Verwendung ungeeignet machen oder die den Wert beträchtlich verringern. In diese Kategorie fallen Mängel, wie im Dokument definiert 1) Handbuch zur Verlegung, Benutzung, Reinigung und Pflege, veröffentlicht auf der Web-Site des Verkäufers. Als nicht erschöpfende Beispiele werden Oberflächenmängel, fehlerhafte Grafik, Defekte polierte Oberfläche, Defekte des Kalibers, der Planarität, der Rechtwinkligkeit/Gradlinigkeit, der Stärke, Risse, abgeschlagene Kanten, Fehlfarbe, gemischte Brandfarbe sowie Produkte mit Kantsplitterung durch Rettifizierung als offensichtliche Mängel anerkannt.

G.4.- Falls der Käufer offensichtliche Mängel feststellt, muss er dies dem Verkäufer innerhalb von 8 (acht) Tagen ab dem Empfang schriftlich melden und die gesamte Charge des Materials für den Verkäufer zur Verfügung halten; anderenfalls verfällt der Rechtsanspruch. Bei der Beanstandung müssen die Daten der Rechnung sowie eine präzise Beschreibung des beanstandeten Mangels angegeben werden, falls möglich mit einer fotografischen Dokumentation. Falls die Beanstandung unberechtigt sein sollte, ist der Käufer gehalten, dem Verkäufer die für einen eventuellen Ortstermin aufgewendeten Kosten (Gutachten, Reisekosten, usw.) zu erstatten.

G.5.- Versteckte Mängel müssen dem Verkäufer innerhalb von 8 (acht) Tagen ab Feststellung des Mangels per Einschreiben mit Rückschein gemeldet werden; anderenfalls verfällt der Rechtsanspruch.

G.6.- Die Aktion des Käufers zur Inanspruchnahme der Mängelhaftung muss in jedem Fall innerhalb von 12 (zwölf) Monaten ab der Lieferung der Produkte erfolgen.

H.- MÄNGELHAFTUNG

H.1.- Die Garantie des Verkäufers ist begrenzt auf Produkte erster Qualität und sie bezieht sich nicht auf Produkte zweiter oder dritter Qualität oder auf gelegentliche Partien mit besonderen Preisen oder Nachlässe, die in der Auftragsbestätigung angegeben werden.

H.2.- Der Verkäufer garantiert nicht die Eignung der Produkte für besondere Verwendungen, sondern lediglich die technischen Eigenschaften, die auf der Web-Site in Dokument 2) Technische Datenblätter veröffentlicht sind. Die Angabe zur Verwendung ist als unverbindlich anzusehen, auch wenn vom Verkäufer in Katalogen und Handbüchern angegeben ist. Es ist stets Aufgabe des Planers, auf der Grundlage der in den 2) Technischen Datenblättern angegebenen Eigenschaften die Eignung des Produkts für spezifische Nutzungsbedingungen zu bewerten, unter Berücksichtigung der Belastungen sowie der Variablen, die am Ort der Bestimmung auftreten und die Eigenschaften verändern können, wie zum Beispiel die Intensität des Verkehrs, die Qualität des Verkehrs (Begehung bei Vorhandensein von Sand, Schmutz usw.), die eventuellen klimatischen Bedingungen sowie alle sonstigen Einflüsse, denen das Material ausgesetzt sein kann.

H.3.- Falls festgestellt wird, dass das Produkt offensichtliche Mängel aufweist, wie definiert in Punkt G, Nr. 3, nimmt der Verkäufer die Ersetzung des mangelhaften Produkts durch ein anderes mit gleichen oder höherwertigen Eigenschaften vor, oder er nimmt eine angemessene Reduzierung des Preises vor, falls dies nicht möglich ist. Alternativ hat der Käufer nach Rücklieferung der mangelhaften Produkte das Recht auf Rückerstattung des bezahlten Preises, zuzüglich der Transportkosten, mit Ausschließung der Vergütung aller direkten und/oder indirekten Schäden.

H.4. Die Garantie des Verkäufer wird ausgeschlossen, falls das mangelhafte Produkt (ganz oder teilweise) verwendet und/oder umgewandelt worden ist, da davon ausgegangen wird, dass der Käufer (oder sein Kunde) dadurch seinen Willen zum Ausdruck gebracht hat, es in dem Zustand zu akzeptieren, in dem es sich befindet.

H.5 Falls festgestellt wird, dass das Produkt versteckte Mängel aufweist, ist die Garantie des Verkäufers auf die Ersetzung des Materials durch anderes mit gleichen oder höherwertigeren Eigenschaften beschränkt oder - falls dies nicht möglich ist - auf die Rückerstattung des bezahlten Preises, zuzüglich der Transportkosten. In jedem Fall ist die Garantie des Verkäufers für alle direkten und/oder indirekten Schäden, die durch das mangelhafte Produkt entstehen, auf einen Betrag begrenzt, der das Doppelte des Verkaufspreises nicht übersteigen kann, den der Verkäufer auf den mangelhaften Teil der Lieferung angewendet hat.

H.6.- Falls der Käufer das Produkt an Kunden weiterverkauft, die vom Verbraucherschutzgesetz (ital. Gesetzerlass Nr. 206/2005) geschützt werden, ist er verantwortlich für die angewendeten Bedingungen, falls diese von den hier angegebenen abweichen, und er muss sicherstellen, dass die Rechte des Verbrauchers gemäß den Bestimmungen dieses Gesetzes ausgeübt werden können. Falls die Voraussetzungen gegeben sind, kann das Regressrecht des Käufers gegenüber dem Verkäufer/Hersteller nicht die Grenzen übersteigen, die von Punkt G, Nr. 1 bis Punkt H, Nr. 5 angegeben werden.

I. KLAUSEL SOLVE ET REPETE UND AUFLÖSUNGSKLAUSEL

I.1.- Gemäß den Bestimmungen von § 1462 des ital. Bürgerlichen Gesetzbuches kann der Käufer in keinem Fall - einschließlich von vermeintlichen Mängeln oder Defekten des Materials - die Zahlung des abgenommenen Materials aussetzen oder verzögern, natürlich vorbehaltlich des Rechts, ungerechtfertigt gezahlte Beträge zurückzufordern, und dies nur nach Erbringung des Nachweises der Rechtmäßigkeit der Forderung (Solve et Repete).

I.2.- Im Fall der Veränderung der Vermögensbedingungen des Käufers oder der auch nur partiellen Nichtbezahlung der bereits gelieferten Produkte kann der Verkäufer die laufenden Lieferungen aussetzen und/oder die laufenden Verträge auflösen, ohne dass der Käufer die Vergütung von direkten und/oder indirekten Schäden geltend machen kann.

L.- EIGENTUMSVORBEHALT

L.1.- Bis zur vollständigen Bezahlung des Preises durch den Käufer bleiben die Produkte, die den Gegenstand der Lieferung darstellen, Eigentum des Verkäufers.

L.2.- Während dieses Zeitraums übernimmt der Käufer die Pflichten und die Verantwortlichkeiten für die Aufbewahrung der gekauften Produkte und er kann sie nicht veräußern, zur Nutzung überlassen oder beschlagnahmen oder pfänden lassen, ohne das Eigentum des Verkäufers anzugeben und ohne diesen umgehend per Einschreiben mit Rückschein zu benachrichtigen.

M.- HÖHERE GEWALT

M.1.- Beide Parteien können die Ausführung der vertraglichen Pflichten aussetzen, wenn die Ausführung aus Gründen, die vom eigenen Willen unabhängig sind, unmöglich oder objektiv zu aufwendig wird, wie zum Beispiel: Streiks, Boykott, Aussperrung, Brand, Krieg (erklärt oder nicht), Bürgerkrieg, Aufstände und Revolutionen, Beschlagnahme, Embargo, Unterbrechungen der Energieversorgung, außerordentliche Defekte von Maschinen, Verspätung bei der Anlieferung von Komponenten und Rohstoffen.

M.2.- Die Partei, die beabsichtigt, die vorliegende Klausel in Anspruch zu nehmen, muss der anderen Partei schriftlich das Auftreten von Umständen der Höheren Gewalt mitteilen.

M.3.- Falls die Aussetzung aufgrund von Höherer Gewalt mehr als 60 (sechzig) Tage andauert, haben beiden Parteien das Recht, den vorliegenden Vertrag nach einer schriftlichen Vorankündigung von 10 (zehn) Tagen an die Gegenpartei aufzulösen.

N.- VERTRAULICHKEITSPFLICHT

N.1.- Der Käufer ist gehalten, über alle technischen Informationen (wie zum Beispiel Zeichnungen, Prospekte, Dokumentationen, Formeln und Schriftverkehr) und kommerziellen Informationen (einschließlich der Vertragsbedingungen, der Kaufpreise, der Zahlungsbedingungen usw.), in deren Kenntnis während der Ausführung des vorliegenden Vertrages kommt, absolute Vertraulichkeit einzuhalten.

N.2.- Die Vertraulichkeitspflicht wird für die Dauer des Vertrages sowie den Zeitraum nach seiner Ausführung übernommen.

N.3.- Im Fall der Nichteinhaltung der Vertraulichkeitspflicht ist die nicht einhaltende Partei gehalten, der anderen Partei alle daraus entstehenden Schäden zu vergüten.

O.- MARKEN UND KENNZEICHNUNGEN DES VERKÄUFERS

O.1.-Die Verwendung von Marken, Ziermotiven und geistigem Eigentum im Allgemeinen in jeder Form sowie jeder Ausdrucksform (als nicht erschöpfendes Beispiel: Bilder, Fotos, Zeichnungen, Filme, Abbildungen, Strukturen usw.), die intellektuelles Eigentum des Verkäufers sind, ist auf jede Weise (als nicht erschöpfendes Beispiel: Presse, Video, Radio, Internet, Social Media, Instant-Message-Plattform oder VoIP usw.) strengstens untersagt. Alle - auch nur partielle - Abweichungen von diesem Verbot müssen von Fall zu Fall schriftlich von der Generaldirektion des Verkäufers autorisiert werden.

P.- SPRACHE DES VERTRAGS, ANWENDBARES RECHT, RECHTSPRECHUNG UND GERICHTSSTAND

P.1.- Der Vertrag und die vorliegenden Bedingungen werden in italienischer Sprache verfasst, die im Fall der Abweichung der Übersetzung in andere Sprachen Vorrang hat.

P.2.- Die Regelung aller Rechtssachen hinsichtlich den Lieferungen unterliegt der Rechtsprechung des italienischen Staats und die territoriale Zuständigkeit liegt ausschließlich beim Bezirksgericht Modena, dem Ort des Firmensitzes des Verkäufers.

CONDICIONES GENERALES DE VENTA / Rev.1a de 1 de Enero 2018

A.- MODALIDADES DE CELEBRACIÓN DEL CONTRATO

A.1.- Las presentes Condiciones Generales de Venta disciplinan todo contrato de venta entre el Vendedor y el Comprador y toda modificación o cancelación debe ser establecida por escrito.

A.2.- Eventuales ofertas, acreditaciones y/o descuentos otorgados por agentes u otros intermediarios, no son considerados válidos mientras no sean confirmados por escrito por el Vendedor.

A.3.- El Comprador envía al Vendedor, directamente o a través de agentes, pedidos por escrito que deben contener la indicación de los códigos de los productos requeridos, de las cantidades, de sus precios y de su destino. El pedido enviado por el Comprador es irrevocable.

A.4.- La venta deberá considerarse perfeccionada desde el momento en que: (a) el Comprador recibe por parte del Vendedor una confirmación -escrita a través de e-mail, fax u otros medios telemáticos- conforme con los términos y según las condiciones del pedido; o (b) en caso de confirmación enviada por el Vendedor que contenga condiciones diferentes de las del pedido enviado por el Comprador cuando este las acepte por escrito o, en todo caso, no las cuestione dentro de los 7 (siete) días sucesivos a la recepción; o (c) en ausencia de confirmación escrita por el Vendedor, en el momento en que los productos serán entregados y serán cargados por el Comprador.

B.- PRECIOS

B.1.- Salvo acuerdo escrito en contrario, los precios de venta acordados de manera puntual se entienden al neto en efectivo y para entrega en el establecimiento del Vendedor indicado en la confirmación del pedido.

C.- CARACTERÍSTICAS DE LOS PRODUCTOS

C.1.- El Comprador declara haber visto y atenderse al contenido de la siguiente documentación publicada en el sitio internet de la empresa: 1) Manual de Colocación, Uso, Limpieza y Mantenimiento y 2) Fichas Técnicas.

C.2. Dada la intrínseca variabilidad del producto cerámico, las características de las muestras y/o modelos enviados anteriormente por el Vendedor al Comprador deben ser considerados como aproximados y no vinculantes.

C.3. Salvo especificaciones requeridas, a acordar antes de la confirmación del pedido, el Vendedor no garantiza que el pedido de un artículo en particular sea despachado como un mismo lote de producción.

D.- PLAZOS DE ENTREGA

D.1.- Los plazos de entrega deben entenderse como aproximados y su prórroga no puede devengar a favor del Comprador ningún derecho a solicitar indemnizaciones, sin excepciones posibles.

D.2.- Si, una vez transcurridos 10 (diez) días desde la fecha de aviso de estar lista la mercancía, el Comprador no retira el material, el Vendedor se reserva de establecer discrecionalmente un nuevo plazo de entrega.

E.- ENTREGA Y TRANSPORTE

E.1.- La eventual variación de lugar de destino de los productos, señalando uno diferente respecto de aquel acordado en la confirmación de pedido, debe ser comunicada por el Comprador por escrito dentro del plazo máximo taxativo del penúltimo día previo al retiro desde el establecimiento del Vendedor. El Vendedor se reserva la facultad de no aceptar el cambio de lugar de destino de los Productos. En caso de verificarse que el destino efectivo del producto sea diferente de aquel declarado por el Comprador, el Vendedor se reserva la facultad de suspender la realización de los suministros en curso y/o de rescindir los contratos en curso sin que el Comprador pueda pedir resarcimientos directos y /o indirectos de ningún tipo.

E.2.- Salvo acuerdo en contrario, el suministro de la mercancía se entiende ex Works (EXW según Incoterms 2010) y ello también cuando se acuerde que el transporte o parte de él quede a cargo del Vendedor, según mandato del Comprador. En todo caso, los riesgos se transfieren al Comprador a más tardar con la entrega al primer transportador.

E.3.- Como confirmación del hecho de que el Vendedor es ajeno al contrato de transporte, el mismo no podrá ser indicado como “shipper” en la póliza de carga. La comunicación del peso bruto del contenedor al transportista no comporta ninguna asunción de responsabilidad de parte del Vendedor para los fines del Convenio SOLAS (Safety Of Life At Sea). De ninguna manera la antedicha comunicación podrá ser considerada como VGM (Verified Gross Mass).

E.4.- El Comprador se compromete a fin de que el vehículo enviado al establecimiento del Vendedor sea idóneo para cargar considerando la naturaleza de los productos. En caso de que el vehículo que se presenta comporte significativas dificultades para las operaciones de carga, el Vendedor se reserva el derecho a incluir una recarga del 4 % del valor de los productos a cobertura de los mayores costos logísticos. Si el vehículo enviado para retirar la mercancía no es absolutamente idóneo, el Vendedor se reserva la facultad de negar las operaciones de carga sin que nada pueda requerir el Comprador a título de resarcimiento por todo eventual costo directo y/o indirecto que de ello pueda derivar.

E.5.- Es tarea del Comprador encargar al transportista controlar los productos antes de cargarlos; eventuales observaciones sobre la integridad de los embalajes y la exactitud de las cantidades cargadas, así como aquellas puestas en el documento de transporte, deben ser presentadas por el transportista en el momento de cargar. Estas observaciones deben ser reproducidas en todas las copias de los documentos de transporte; de lo contrario los productos cargados se entienden íntegros y completos. De ello deriva que el Vendedor no se asume ninguna responsabilidad con referencia a faltas o daños en los productos no señalados por el transportista.

E.6.- Asimismo, es responsabilidad del Comprador encargar al transportista verificar las modalidades y la estabilidad de la carga sobre el vehículo a fin de que durante el transporte no se produzcan roturas y que sean respetadas todas las disposiciones sobre seguridad relativas a la circulación por vías públicas.

F.- PAGOS

F.1.- Toda obligación de pago debe ser cumplida en la sede legal del Vendedor. Eventuales pagos a agentes, representantes o auxiliares de comercio no se entienden efectuadas mientras las respectivas sumas no lleguen a poder del Vendedor.

F.2.- Queda prohibido para el Comprador cumplir su propia obligación mediante pagos provenientes de países que no sean su propio país de residencia si se trata de países que no garantizan adecuado intercambio de informaciones con Italia. En caso de violación de esta prohibición, el Vendedor tiene facultad de rescindir el contrato por justa causa sin que el Comprador pueda pretender derecho de obtener algún resarcimiento por eventual daño sufrido.

F.3.- Eventuales gastos de sello fiscal y de cobro de letras de cambio y efectos comerciales quedan a cargo del Comprador. En caso de incumplimiento, incluso solo parcial, del día fijado para el pago, se devengarán a favor del Vendedor los intereses de mora en la medida prevista por el Decreto Leg. nº 231 del 09/10/2002.

F.4.- Salvo acuerdos escritos que lo contradigan, el Comprador se compromete a no compensar ningún crédito de cualquier forma creado respecto del Vendedor.

G.- RECLAMOS

G.1.- Al recibir los productos, el Comprador deberá someterlos a cuidadoso control a través de un examen visual efectuado conforme según las indicaciones del punto 7.4 de las normas UNI EN ISO 10545-2.

G.2.- La instalación y colocación de los productos deberá efectuarse respetando escrupulosamente las recomendaciones inherentes a las actividades a realizar antes y durante la colocación, indicadas en el documento 1) Manual de Colocación, Uso, Limpieza y Mantenimiento publicado en el sitio internet del Vendedor y en el embalaje del producto y/o en el interior del mismo. No son considerados como vicios del producto aquellos generados por una errónea instalación y error/falta de mantenimiento (intervenciones diferentes de las instrucciones proporcionadas en el 1) Manual de Colocación, Uso, Limpieza y Mantenimiento), por un uso inapropiado y/o por el normal desgaste con el pasar del tiempo.

G.3.- Sin perjuicio de los límites de aceptabilidad previstos por la norma internacional EN 14411 (ISO 13006), las partes reconocen como vicios evidentes los defectos de los productos constatables ya en el momento de su recepción y tales que impidan el uso previsto del material o reduzcan de modo apreciable su valor. Forman parte de esta categoría los defectos precisamente establecidos en el documento 1) Manual de Colocación, Limpieza y Mantenimiento publicado en el sitio internet del Vendedor. A título solo de ejemplo, se reconocen como vicios evidentes los defectos superficiales, los defectos de decoración, de lapeado/pulido, de calibre, de planitud, de ortogonalidad-rectilineidad, de espesor, las grietas, los astillados, las variaciones

de tono, los tonos mezclados y los productos que presentan problemas de cortes/escamas.

G.4.- En caso de que el Comprador observe la presencia de vicios evidentes, deberá presentar reclamo al Vendedor por escrito, so pena de extinción del derecho, dentro de los 8 (ocho) días sucesivos a la recepción y mantener a disposición del Vendedor la partida completa de material. El reclamo deberá indicar los datos de facturación y una precisa descripción del vicio observado incluyendo, en lo posible, imágenes fotográficas. En caso de que el reclamo debiera demostrarse luego ser infundado, el Comprador se declara dispuesto a resarcir al Vendedor por los gastos efectuados para realizar la respectiva constatación in situ (peritajes, viajes, etc.).

G.5.- Los vicios ocultos deberán ser notificados al Vendedor mediante carta certificada con aviso de recibo, bajo pena de caducidad de la garantía, dentro de los 8 (ocho) días a contar de la fecha del descubrimiento del defecto.

G.6.- La acción del Comprador tendiente a hacer valer la garantía por vicios prescribe, en todo caso, en el plazo de 12 (doce) meses a contar de la entrega de los productos.

H.- GARANTÍA POR VICIOS

H.1.- La garantía del Vendedor se entiende limitada solo a los productos de primera selección y no a los productos de segunda o tercera selección o de partidas de ocasión con precios o descuentos especiales cuando ello se encuentra debidamente señalados en nota en la confirmación del pedido.

H.2. El Vendedor no garantiza la idoneidad de los productos para usos particulares, sino solo las características técnicas publicadas en el sitio internet, documento 2) Fichas Técnicas. La indicación de uso, incluso cuando es presentada por el Vendedor en catálogos y manuales, debe considerarse solo como genérica. Sobre la base de las características técnicas señaladas en las 2) Fichas Técnicas, es siempre tarea del proyectista evaluar la idoneidad del producto en función de las condiciones específicas de uso en consideración de las solicitudes y de las variables que pueden operar en el ambiente de destino, alterando sus características; a título de ejemplo: la intensidad del tráfico, la calidad del tráfico (tránsito en presencia de arena, de detritos, etc.), las eventuales condiciones climáticas adversas y cualquier otro factor aleatorio al que puede quedar expuesto el material.

H.3.- En caso de comprobarse que el producto manifieste vicios evidentes, tal como han sido definidos en la letra G nº. 3, el Vendedor procederá a sustituir el producto defectuoso con otro con características iguales o superiores o, en el caso de que ello no sea posible, deberá efectuar una congrua reducción del precio. Como alternativa, el Comprador tendrá derecho, previa devolución de los productos viciados, al reembolso del precio pagado, agregándose el costo del transporte, con exclusión del resarcimiento de todo otro daño, directo y/o indirecto.

H.4. La garantía del Vendedor debe considerarse excluida en caso de que el producto que presenta vicios evidentes (total o parcialmente) haya sido utilizado y/o, en cualquier caso, transformado, debiéndose estimar que de tal modo el Comprador (o su cliente) ha expresado la voluntad de aceptarlo en el estado en que se encuentra.

H.5 En los casos en que quede comprobado que el producto presenta vicios ocultos, la garantía del Vendedor queda limitada a la sustitución del material con otro de características iguales o superiores y, allí donde ello no sea posible, al reembolso del precio pagado, agregándose el costo del transporte. En todo caso, la garantía del Vendedor por cada daño directo y/o indirecto de cualquier forma derivado de producto defectuoso, debe entenderse limitada a una suma que no podrá superar el doble del precio de venta aplicado por el Vendedor, con referencia solo a la parte defectuosa del suministro.

H.6.- En caso de que el Comprador revenda el producto a terceros protegidos por el código del consumo (D.L. nº. 206/2005), será responsable de las condiciones practicadas si son diferentes de aquellas aquí señaladas y deberá comprobarse que los derechos del consumidor sean ejercidos con aplicación de los remedios y de los términos fijados por el antedicho código. En caso de subsistir las condiciones, el derecho de devolución y/o, en todo caso, de compensación a favor del Comprador respecto del Vendedor/productor, no podrán excederse las exenciones ni límites establecido en la letra G del nº. 1 y en la letra H nº. 5.

I. CLÁUSULAS SOLVE ET REPETE Y RESOLUTIVAS

I.1.- De conformidad con lo dispuesto por el art. 1462 del Código Civil, por ningún motivo, incluidos supuestos vicios o defectos del material, el Comprador podrá suspender o retardar el pago del material retirado, sin perjuicio obviamente de la facultad de restitución cuando pueda demostrar que ha pagado indebidamente.

I.2.- En el caso de cambiar las condiciones patrimoniales del Comprador o de falta de pago incluso parcial de productos ya suministrados, el Vendedor podrá suspender la realización de los suministros en curso y/o rescindir los contratos en curso sin que el Comprador pueda reivindicar resarcimientos directos ni indirectos de cualquier clase.

L.- PACTO DE RESERVADO DOMINIO

L.1.- Mientras el Comprador no haya efectuado el pago integral del precio, los productos objeto del suministro seguirán siendo de propiedad del Vendedor.

L.2.- Durante el período antedicho, el Comprador asumirá las obligaciones y las responsabilidades del depositario y no podrá enajenar, entregar en uso ni dejar retener o embargar los productos sin declarar la propiedad del Vendedor y enviar inmediatamente aviso con carta certificada con aviso de recibo.

M.- FUERZA MAYOR

M.1.- Cada parte podrá suspender la ejecución de sus obligaciones contractuales cuando esa ejecución se haga imposible u objetivamente demasiado onerosa por impedimento imprevisible independiente de su voluntad, tal como por ejemplo: huelga, boicot, bloqueo, incendio, guerra (declarada o no declarada), guerra civil, rebelión y revolución, requisición, embargo, interrupción de energía, rotura extraordinaria de maquinaria, retraso en la entrega de componentes o materias primas.

M.2.- La parte que desee valerse de la presente cláusula deberá comunicar de inmediato por escrito a la otra parte el verificarse y el cese de las circunstancias de fuerza mayor.

M.3.- En caso de que la suspensión causada por fuerza mayor dure más de 60 (sesenta) días, cada una de las partes tendrá derechos de rescindir el presente contrato, con preaviso de 10 (diez) días, a comunicar a la otra parte por escrito.

N.- OBLIGACIÓN DE CONFIDENCIALIDAD

N.1.- El Comprador debe mantener la más absoluta confidencialidad respecto de todas las informaciones de carácter técnico (tales como, solo como ejemplo, diseños, prospectos, documentaciones, fórmulas y correspondencia) y de carácter comercial (incluidas las condiciones contractuales, los precios de compra, las condiciones de pago, etc.) obtenidas a propósito de la ejecución del presente contrato.

N.2.- La obligación de confidencialidad es válida por toda la duración del contrato, así como por el periodo sucesivo a su ejecución.

N.3.- En cualquier caso de inobservancia de la obligación de confidencialidad, la parte incumplidora deberá indemnizar a la otra por todos los daños que de ello puedan derivar.

O.- MARCAS Y SIGNOS DISTINTIVOS DEL VENDEDOR

O.1.- Queda severamente prohibido el uso a través de cualquier medio (tales como, solo a título de ejemplos no exhaustivos: prensa, videos, radio, internet, social media, plataformas de mensajería instantánea o VoIP, etc.) de las marcas, de los modelos ornamentales y de las obras del ingenio en general que constituyan propiedad intelectual del Vendedor y ello en cualquier forma o modo de expresión (tales como, solo a título de ejemplos no exhaustivos: imágenes, fotos, dibujos, videos, figuras, estructuras, etc.).

Cualquier excepción a esta prohibición, incluso solo parcial, deberá ser autorizada caso por caso por escrito por la dirección general del Vendedor.

P- IDIOMA DEL CONTRATO, LEY APLICABLE, JURISDICCIÓN Y COMPETENCIA

P.1.- El contrato y las presentes condiciones son redactados en lengua italiana, la cual prevalecerá en caso de divergencia con las traducciones en otros idiomas.

P.2.- La resolución de cualquier controversia de cualquier forma relativa al suministro queda sujeta a la ley y a la jurisdicción del Estado Italiano y la competencia territorial es asignada de forma exclusiva al Tribunal de Módena, en cuya circunscripción el Vendedor tiene su domicilio legal.

IT_

Ceramiche Keope raccomanda l'utilizzo delle lastre in spessore 6 mm per le sole applicazioni in ambito residenziale, commerciale a traffico leggero e comunque in contesti ove non vi sia passaggio di carichi puntuali pesanti o transito di carrelli a ruote dure. Oltre all'utilizzo a rivestimento è inoltre possibile posarle su pavimenti preesistenti in marmo, pietra naturale o ceramica, senza la necessità di demolire la pavimentazione sottostante.

Per l'applicazione su massetto Ceramiche Keope consiglia l'utilizzo del gres porcellanato in spessore tradizionale.

Per una posa ad opera d'arte, consultare Consigli di posa, pulizia e manutenzione al link **keope.com**

IT_

Ceramiche Keope si riserva la facoltà di apportare variazioni ai prodotti illustrati in questo catalogo per necessità produttive o al fine di migliorarne la qualità. I campioni sono puramente indicativi. Gli imballaggi e pesi riportati possono variare per necessità produttive. Consultare gli uffici commerciali al momento dell'ordine.

IT_

Ceramiche Keope si riserva la facoltà di apportare variazioni ai prodotti illustrati in questo catalogo per necessità produttive o al fine di migliorarne la qualità. I campioni sono puramente indicativi. Gli imballaggi e pesi riportati possono variare per necessità produttive. Consultare gli uffici commerciali al momento dell'ordine.

IT_

Ceramiche Keope si riserva la facoltà di apportare variazioni ai prodotti illustrati in questo catalogo per necessità produttive o al fine di migliorarne la qualità. I campioni sono puramente indicativi. Gli imballaggi e pesi riportati possono variare per necessità produttive. Consultare gli uffici commerciali al momento dell'ordine.

IT_

Ceramiche Keope si riserva la facoltà di apportare variazioni ai prodotti illustrati in questo catalogo per necessità produttive o al fine di migliorarne la qualità. I campioni sono puramente indicativi. Gli imballaggi e pesi riportati possono variare per necessità produttive. Consultare gli uffici commerciali al momento dell'ordine.

IT_

Ceramiche Keope si riserva la facoltà di apportare variazioni ai prodotti illustrati in questo catalogo per necessità produttive o al fine di migliorarne la qualità. I campioni sono puramente indicativi. Gli imballaggi e pesi riportati possono variare per necessità produttive. Consultare gli uffici commerciali al momento dell'ordine.

IT_

Ceramiche Keope si riserva la facoltà di apportare variazioni ai prodotti illustrati in questo catalogo per necessità produttive o al fine di migliorarne la qualità. I campioni sono puramente indicativi. Gli imballaggi e pesi riportati possono variare per necessità produttive. Consultare gli uffici commerciali al momento dell'ordine.

IT_

Ceramiche Keope si riserva la facoltà di apportare variazioni ai prodotti illustrati in questo catalogo per necessità produttive o al fine di migliorarne la qualità. I campioni sono puramente indicativi. Gli imballaggi e pesi riportati possono variare per necessità produttive. Consultare gli uffici commerciali al momento dell'ordine.

EN_

Ceramiche Keope recommends the use of 6 mm thick tiles only for residential and low traffic commercial applications. These tiles are not recommended for applications involving the transit of heavy loads or hard-wheeled trolleys. 6 mm thick tiles can be installed as wall coverings and as floor coverings over existing marble, stone or ceramic floors without having to demolish the previous floor.

Ceramiche Keope recommends the use of porcelain tiles of conventional thickness for applications over screed.

To ensure a perfect finish, consult the recommendations for laying, cleaning and maintenance available from **keope.com**

EN_

Ceramiche Keope reserves the right to vary the products illustrated in this catalogue for production purposes or in order to improve quality. Samples are purely indicative. Packaging and weights shown may be varied in line with production requirements. Check with the sales department at the time of order.

EN_

Ceramiche Keope reserves the right to vary the products illustrated in this catalogue for production purposes or in order to improve quality. Samples are purely indicative. Packaging and weights shown may be varied in line with production requirements. Check with the sales department at the time of order.

EN_

Ceramiche Keope reserves the right to vary the products illustrated in this catalogue for production purposes or in order to improve quality. Samples are purely indicative. Packaging and weights shown may be varied in line with production requirements. Check with the sales department at the time of order.

EN_

Ceramiche Keope reserves the right to vary the products illustrated in this catalogue for production purposes or in order to improve quality. Samples are purely indicative. Packaging and weights shown may be varied in line with production requirements. Check with the sales department at the time of order.

EN_

Ceramiche Keope reserves the right to vary the products illustrated in this catalogue for production purposes or in order to improve quality. Samples are purely indicative. Packaging and weights shown may be varied in line with production requirements. Check with the sales department at the time of order.

EN_

Ceramiche Keope reserves the right to vary the products illustrated in this catalogue for production purposes or in order to improve quality. Samples are purely indicative. Packaging and weights shown may be varied in line with production requirements. Check with the sales department at the time of order.

EN_

Ceramiche Keope reserves the right to vary the products illustrated in this catalogue for production purposes or in order to improve quality. Samples are purely indicative. Packaging and weights shown may be varied in line with production requirements. Check with the sales department at the time of order.

EN_

Ceramiche Keope recommends the use of 6 mm thick tiles only for residential and low traffic commercial applications. These tiles are not recommended for applications involving the transit of heavy loads or hard-wheeled trolleys. 6 mm thick tiles can be installed as wall coverings and as floor coverings over existing marble, stone or ceramic floors without having to demolish the previous floor.

Ceramiche Keope recommends the use of porcelain tiles of conventional thickness for applications over screed.

To ensure a perfect finish, consult the recommendations for laying, cleaning and maintenance available from **keope.com**

EN_

Ceramiche Keope reserves the right to vary the products illustrated in this catalogue for production purposes or in order to improve quality. Samples are purely indicative. Packaging and weights shown may be varied in line with production requirements. Check with the sales department at the time of order.

EN_

Ceramiche Keope reserves the right to vary the products illustrated in this catalogue for production purposes or in order to improve quality. Samples are purely indicative. Packaging and weights shown may be varied in line with production requirements. Check with the sales department at the time of order.

EN_

Ceramiche Keope reserves the right to vary the products illustrated in this catalogue for production purposes or in order to improve quality. Samples are purely indicative. Packaging and weights shown may be varied in line with production requirements. Check with the sales department at the time of order.

EN_

Ceramiche Keope reserves the right to vary the products illustrated in this catalogue for production purposes or in order to improve quality. Samples are purely indicative. Packaging and weights shown may be varied in line with production requirements. Check with the sales department at the time of order.

EN_

Ceramiche Keope reserves the right to vary the products illustrated in this catalogue for production purposes or in order to improve quality. Samples are purely indicative. Packaging and weights shown may be varied in line with production requirements. Check with the sales department at the time of order.

EN_

Ceramiche Keope reserves the right to vary the products illustrated in this catalogue for production purposes or in order to improve quality. Samples are purely indicative. Packaging and weights shown may be varied in line with production requirements. Check with the sales department at the time of order.

EN_

Ceramiche Keope reserves the right to vary the products illustrated in this catalogue for production purposes or in order to improve quality. Samples are purely indicative. Packaging and weights shown may be varied in line with production requirements. Check with the sales department at the time of order.



HEADQUARTER via statale 467, 21
42013 Casalgrande (RE) - Italy

FACTORY via canale, 67
42013 Casalgrande (RE) - Italy

WAREHOUSE via dell'industria, 1
42013 Casalgrande (RE) - Italy

PHONE +39 0522 997511

FAX +39 0522 997544 (OT) - 545 (IT)

ADMIN. FAX +39 0522 997413

info@keope.com

keope.com

